FASTENERS

SECTION 1

PAGE

BINS.....	1-3
BRASS FITTINGS.....	50-60
Airbrake Components.....	59
Airbrake for Copper: Sleeves, Nuts, Unions, Connectors, Elbows, Coupling, Draincock.....	58
Airbrake for Nylon: Sleeves, Nuts, Unions, Inserts, Connectors, Elbows, Tubing.....	57
Compression Fittings: Sleeves, Nuts, Unions, Elbows, Connectors.....	55
Drain and Shut Off Valves.....	59
Glad Hands.....	60
Hydraulic Brake: Nuts, Adaptors, Tees, Brake Lines.....	56
Inverted Flare: Nuts, Plugs, Connectors, Unions, Elbows, Tee's.....	51
Pipe Fittings: Caps, Plugs, Adaptors, Bushings, Unions, Couplings.....	53
Nipples, Elbows, Tee's, Cross.....	54
Special Purpose Water Adaptors.....	60
45° Flare: Nuts, Unions, Connectors, Elbows.....	52
CABINETS.....	1-3
CABLE TIES.....	64
CAP SCREWS, GRADE 5 USS.....	4
CAP SCREWS, GRADE 5 SAE.....	5
CAP SCREWS, GRADE 8 USS.....	6
CAP SCREWS, GRADE 8 SAE.....	7
CARRIAGE BOLTS.....	11
COLL-O-CRIMP FITTINGS.....	46-49
COTTER PINS.....	20,29
CRIMP 'N SEAL TERMINALS.....	66
CRIMPING TOOL.....	65
DRAWERS, PULL-OUT.....	3
E.C.M. TERMINALS.....	77,78
ELECTRICAL TERMINALS.....	65,66,68-78
FASTENER BINS.....	1-3
FENDER WASHERS.....	22
FLAT WASHERS.....	21,22
FUSE HOLDER TERMINALS.....	68

GM METRIC.....	34-45
Acorn Nuts.....	34
Body Bolts.....	39
Bumper Bolts.....	40
CA Point Screws.....	41,42
Dog Point Screws.....	40
Extruded Nuts.....	37,38
Flange Nuts.....	44
Machine Screws.....	45
Miscellaneous GM Metric.....	45
Nuts.....	34-38,44
Push Nuts.....	34
Sheet Metal Screws.....	39,43,45
Spare Tire Holddown.....	45
Stamped Hex Nuts.....	35
Stamped Nuts.....	35,36
T-Bolts.....	45
Torx Screws.....	39
Trim Screws.....	39
U-Nuts.....	37,38
Wing Nuts.....	45
HEAT SHRINK TERMINALS.....	66
HEAT SHRINK TUBING.....	67
JAPANESE METRICS.....	33
KEY STOCK.....	23
LOCK WASHERS.....	22,28
MACHINE SCREWS.....	12,13,31,32
MACHINE SCREW NUTS.....	12,13
METRICS, STANDARD.....	25-33
Metric Cap Screws, Fine.....	26
Metric Cap Screws, Standard.....	25
Metric Cotter Pins.....	29
Metric Flange Bolts.....	33
Metric Flange Nuts.....	33
Metric Hex Nuts.....	27
Metric Jam Nuts.....	27
Metric Japanese Small Head Cap Screws.....	33
Metric Japanese Small Head Hex Nuts.....	33
Metric Lock Rings.....	30
Metric Machine Screws.....	31,32
Metric Nylon Lock Nuts.....	27
Metric Washers (Flat and Lock).....	28
Metric Washers (Spring).....	29
Metric Woodruff Keys.....	30
NUTS, HEX.....	4-7,27-45
Grade 5 USS.....	4
Grade 5 SAE.....	5
Grade 8 USS.....	6
Grade 8 SAE.....	7
Metric STD.....	27
Metric Jam.....	27
Metric Nylon Locking.....	27
Metric Flange Nuts.....	33
Japanese Small Head.....	33
GM Metric.....	34-38,44,45

NYLON INSULATED TERMINALS.....	76
PIDGEON HOLE BINS.....	2
RIVET GUNS.....	61
RIVETS-ALUMINUM.....	62
RIVETS-NYLON.....	63
ROUND STOCK.....	24
SCOTCHLOCK CONNECTORS.....	65
SHEET METAL SCREWS.....	14-19
SOCKET HEAD CAP SCREWS.....	8,9
SOCKET SET SCREWS.....	10
SQUARE KEY STOCK.....	23
TERMINALS.....	65,66,68-78
TRAILER CONNECTORS.....	68
WASHERS-FLAT.....	21-22
WASHERS-LOCK.....	22
WASHERS, METRIC.....	28,29
Metric Flat.....	28
Metric Lock.....	28
Metric Spring.....	29
VINYL INSULATED TERMINALS.....	73-75
WIRE NUTS.....	68
WIRE RACK.....	2
WIRING HARNESS CONNECTORS.....	68
WOODRUFF KEYS.....	30

Custom designed for the new car dealer... modular design fits almost anywhere!

USE THAT UNUSABLE SPACE!

Now that narrow aisle, narrow alcove, window wall or most any other type of unusable floor or wall space can be utilized for storage and control of your fasteners, clips, fittings and many other small parts.

TOTAL INVENTORY CONTROL!

S & S Automotive, Inc. feels that you should buy only what you need! We specialize in small quantities per package so that your bolts, nuts, rivets and other small parts can be charged to the job.

REDUCE INVENTORY COSTS!

The S & S Automotive, Inc. sales specialist makes more frequent calls, making sure that you don't run out of needed small parts...while keeping your dollar investment to a minimum.

CUSTOM DESIGN!

Why stock a three-to-six month supply of small parts...tying up dollars...when this specialized program saves you money, space and waste! Tilt bins let you see exactly what you have in stock.

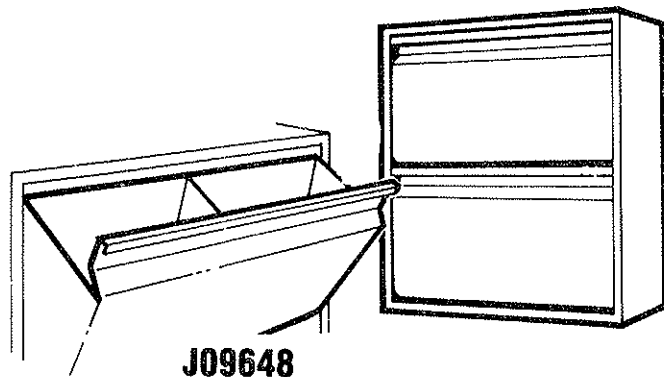

J09648

More depth for those bulkier items; caulking cartridges, flashlights, roll of tape and other shop supplies.

TWO TILT BINS

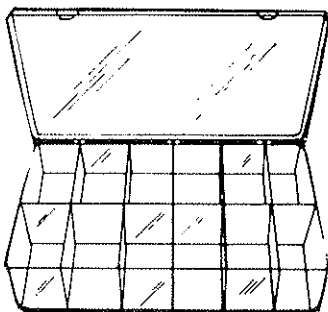

J602

12 Compartment
See-Thru Tray

J09649

6 inch height adds stability and better visibility.

Base Only

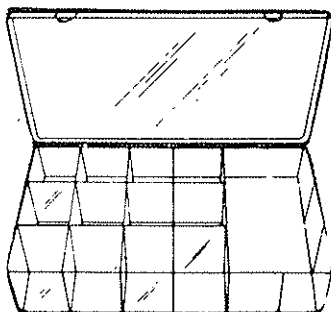
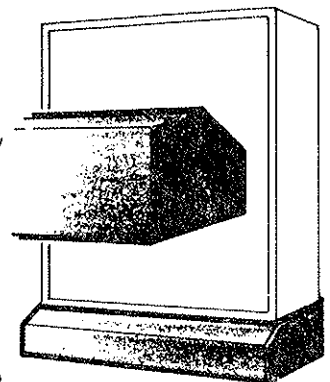

J623

13 Compartment
See-Thru Tray

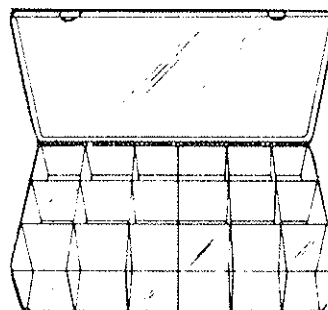

J618

18 Compartment
See-Thru Tray

STORAGE BINS

Heavy duty pigeon hole type bins that can be used for storage of a variety of parts. Storage bins, produced of heavy gauge steel, finished in rust and acid resistant baked enamel, will not warp, twist, or sag out of alignment

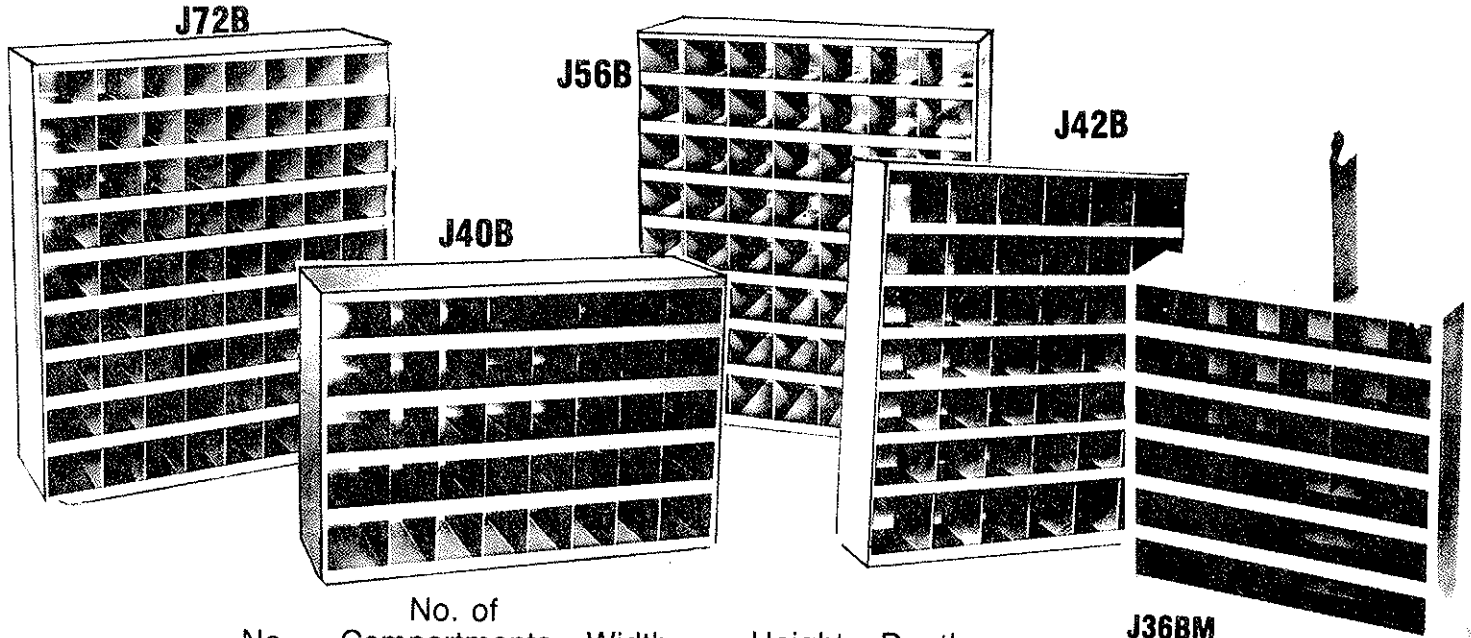

No.	No. of Compartments	Width	Height	Depth
J72B	72	35 1/4"	42"	12"
J56B	56	35 1/4"	42"	12"
J42B	42	35 1/4"	42"	12"
J40B	40	35 1/4"	24"	12"
J36BM	36	23 5/8"	23 5/8"	4 3/4"

Each bin has a scooped bottom. Vertical dividers are removable, allowing creation of double width bins. Keyhole slots provided for wall mounting and locating dimples permit stacking.

CABINETS & RACKS

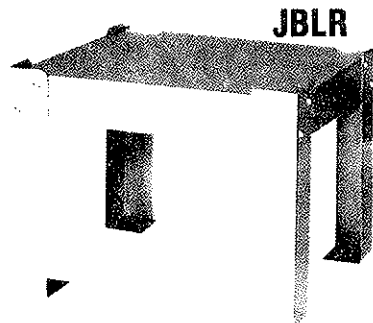

Base for large rack.

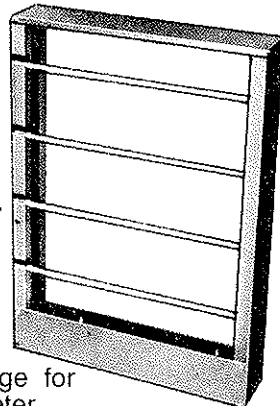

JWSR

WIRE SPOOL RACK

Secure and convenient storage for reels as large as 11" in diameter.

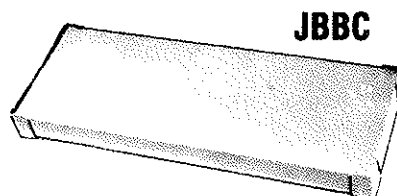

Special base available with or without legs for all bins.

Part No.	Description
JBBC	BIN BASE
JBLR	BASE FOR LARGE RACK
JWSR	WIRE SPOOL RACK

JSPR SINGLE ROD WIRE SPOOL RACK

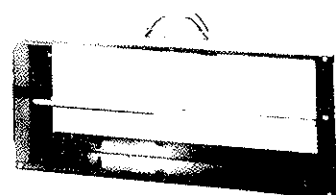

HOLD UP TO 10" DIAMETER SPOOL

WIDTH (inch)	HEIGHT (inch)	DEPTH (in)
26 1/8	10 3/8	5 15/16

DRAWERS

Heavy duty storage drawers manufactured of prime cold rolled steel finished in baked enamel. All scoop drawers have sloped front to back compartments to make removal of parts easy.

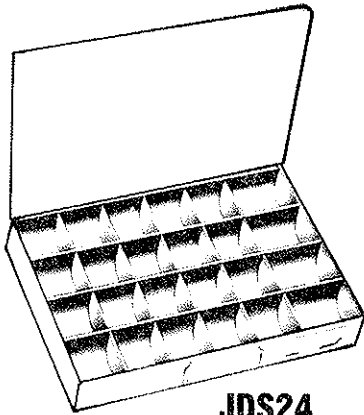

JDS24

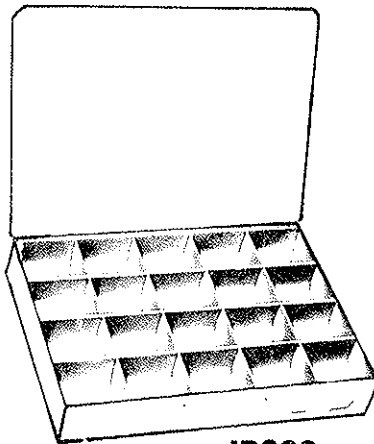

JDS20

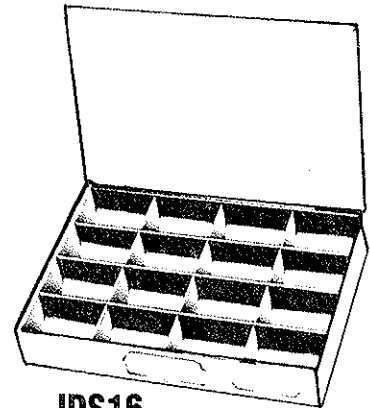

JDS16

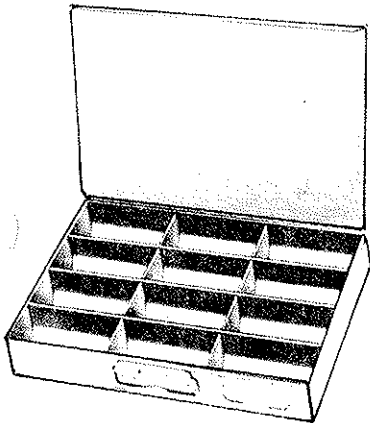

JDS12

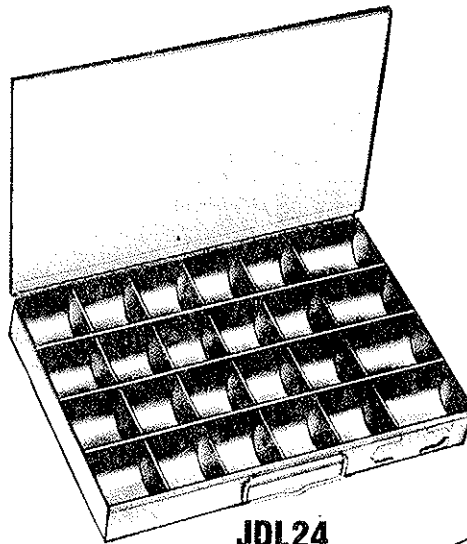

JDL24

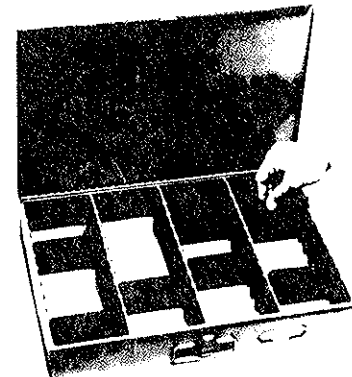

JADLC

Adjustable drawer with 9 dividers.

No.	Compartments	Length	Depth	Height
JDS24	24	13 5/16"	9 1/4"	2"
JDS20	20	13 5/16"	9 1/4"	2"
JDS16	16	13 5/16"	9 1/4"	2"
JDS12	12	13 5/16"	9 1/4"	2"
JDL24	24	18"	12"	3"
JADLC	Adj.	18"	12"	3"

Racks available to hold four (4) drawers, either large or small size.

RACKS

LR Large
4SR Small

Cabinet will not tilt even with fully loaded drawers in open position.

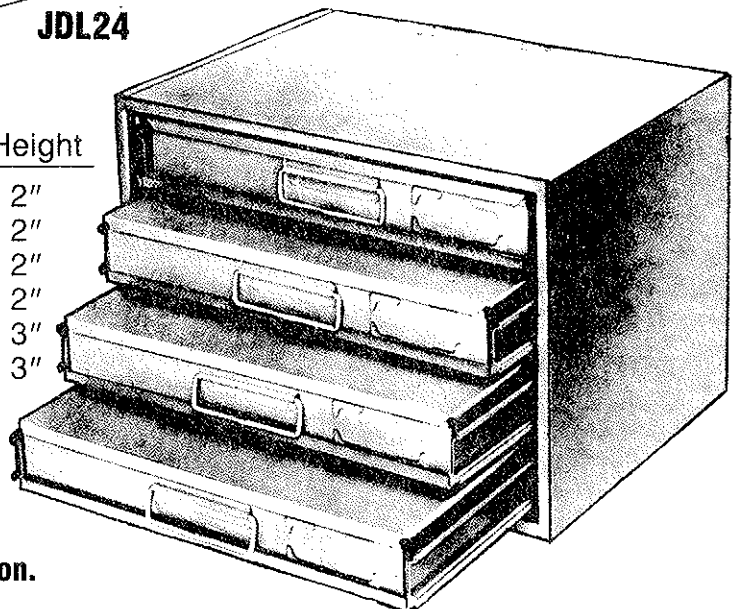

GRADE 5 HEX HEAD (PLATED) CAP SCREWS

USS COARSE THREAD

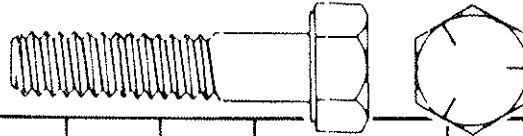

DIAMETER LENGTH	1/4-20	5/16-18	3/8-16	7/16-14	1/2-13	5/8-12	3/4-11	7/8-10	1-8	
	1/2	(10) J16000	(10) J16020	(10) J16040						
5/8	(10) J16001									
3/4	(10) J16002	(10) J16021	(10) J16041	(10) J16060	(10) J16079					
1	(10) J16003	(10) J16022	(10) J16042	(10) J16061	(10) J16080	(5) J16099	(5) J16120	(5) J16137		
1 1/4	(10) J16004	(10) J16023	(10) J16043	(10) J16062	(10) J16081	(5) J16100	(5) J16121	(5) J16138		
1 1/2	(10) J16005	(10) J16024	(10) J16044	(10) J16063	(10) J16082	(5) J16101	(5) J16122	(2) J16140	(2) J16155	(2) J16174
1 3/4	(10) J16006	(10) J16025	(10) J16045	(10) J16064	(10) J16083	(5) J16102	(5) J16123	(2) J16141	(2) J16156	
2	(10) J16007	(10) J16026	(10) J16046	(10) J16065	(10) J16084	(5) J16103	(5) J16124	(2) J16142	(2) J16160	(2) J16175
2 1/4	(5) J16008	(5) J16027	(5) J16047	(5) J16066	(5) J16085	(5) J16104	(5) J16125	(2) J16143	(2) J16161	(2) J16176
2 1/2	(5) J16009	(5) J16028	(5) J16048	(5) J16067	(5) J16086	(5) J16105	(5) J16126	(2) J16144	(2) J16162	(2) J16177
2 3/4	(5) J16010	(5) J16029	(5) J16049	(5) J16068	(5) J16087	(5) J16106	(5) J16127	(2) J16145	(2) J16163	(2) J16178
3	(5) J16011	(5) J16030	(5) J16050	(5) J16069	(5) J16088	(5) J16107	(5) J16128	(2) J16146	(2) J16164	(2) J16179
3 1/4	(5) J16012	(5) J16031	(5) J16051	(5) J16070	(5) J16089	(2) J16108	(2) J16129	(2) J16147	(2) J16165	(2) J16180
3 1/2	(5) J16013	(5) J16032	(5) J16052	(5) J16071	(5) J16090	(2) J16109	(2) J16130	(2) J16148	(2) J16166	(2) J16181
3 3/4	(5) J16014	(5) J16033	(5) J16053	(5) J16072	(5) J16091	(2) J16110	(2) J16131	(2) J16149	(2) J16167	(2) J16182
4	(5) J16015	(5) J16034	(5) J16054	(5) J16073	(5) J16092	(2) J16111	(2) J16132	(2) J16150	(2) J16168	(2) J16183
4 1/2	(2) J16016	(2) J16035	(2) J16055	(2) J16074	(2) J16093	(2) J16112	(2) J16133	(2) J16151	(2) J16169	(2) J16184
5	(2) J16017	(2) J16036	(2) J16056	(2) J16075	(2) J16094	(2) J16113	(2) J16134	(2) J16152	(2) J16170	(2) J16185
5 1/2	(2) J16018	(2) J16037	(2) J16057	(2) J16076	(2) J16095	(2) J16114	(2) J16135	(2) J16153	(2) J16171	(2) J16186
6	(2) J16019	(2) J16038	(2) J16058	(2) J16077	(2) J16096	(2) J16115	(2) J16136	(2) J16154	(2) J16172	(2) J16187
6 1/2									(2) J16173	
7										(2) J16189
FULL FINISHED HEX NUTS	(10) J16500	(10) J16501	(10) J16502	(10) J16503	(10) J16504	(5) J16505	(5) J16506	(2) J16507	(2) J16508	(2) J16509

GRADE 5 HEX HEAD (PLATED) CAP SCREWS

SAE FINE THREAD

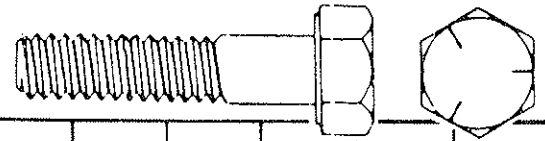

DIAMETER LENGTH	1/4-28	5/16-24	3/8-24	7/16-20	1/2-20	9/16-18	5/8-18	3/4-16	7/8-14	1-14
1/2	(10) J16550	(10) J16570	(10) J16590							
5/8	(10) J16551									
3/4	(10) J16552	(10) J16571	(10) J16591	(10) J16610	(10) J16630					
7/8	(10) J16553									
1	(10) J16554	(10) J16572	(10) J16592	(10) J16611	(10) J16631		(5) J16670	(2) J16687		
1 1/4	(10) J16555	(10) J16573	(10) J16593	(10) J16612	(10) J16632	(5) J16651	(5) J16671	(2) J16688		
1 1/2	(10) J16556	(10) J16574	(10) J16594	(10) J16613	(10) J16633	(5) J16652	(5) J16672	(2) J16690	(2) J16705	
1 3/4	(10) J16557	(10) J16575	(10) J16595	(10) J16614	(10) J16634	(5) J16653	(5) J16673	(2) J16691	(2) J16706	
2	(10) J16558	(10) J16576	(10) J16596	(10) J16615	(10) J16635	(5) J16654	(5) J16674	(2) J16692	(2) J16710	(2) J16730
2 1/4	(5) J16559	(5) J16577	(5) J16597	(5) J16616	(5) J16636	(5) J16655	(5) J16675	(2) J16693	(2) J16711	(2) J16731
2 1/2	(5) J16560	(5) J16578	(5) J16598	(5) J16617	(5) J16637	(5) J16656	(5) J16676	(2) J16694	(2) J16712	(2) J16732
2 3/4	(5) J16561	(5) J16579	(5) J16599	(5) J16618	(5) J16638	(5) J16657	(5) J16677	(2) J16695	(2) J16713	(2) J16733
3	(5) J16562	(5) J16580	(5) J16600	(5) J16619	(5) J16639	(5) J16658	(5) J16678	(2) J16696	(2) J16714	(2) J16734
3 1/4	(5) J16563	(5) J16581	(5) J16601	(5) J16620	(5) J16640	(2) J16659	(2) J16679	(2) J16697	(2) J16715	(2) J16735
3 1/2	(5) J16564	(5) J16582	(5) J16602	(5) J16621	(5) J16641	(2) J16660	(2) J16680	(2) J16698	(2) J16716	(2) J16736
3 3/4	(5) J16565	(5) J16583	(5) J16603	(5) J16622	(5) J16642	(2) J16661	(2) J16681	(2) J16699	(2) J16717	(2) J16737
4	(5) J16566	(5) J16584	(5) J16604	(5) J16623	(5) J16643	(2) J16662	(2) J16682	(2) J16700	(2) J16718	(2) J16738
4 1/2			(2) J16605	(2) J16624	(2) J16644	(2) J16663	(2) J16683	(2) J16701	(2) J16719	(2) J16739
5			(2) J16606	(2) J16625	(2) J16645	(2) J16664	(2) J16684	(2) J16702	(2) J16720	(2) J16740
5 1/2			(2) J16607	(2) J16626	(2) J16646	(2) J16665	(2) J16685	(2) J16703	(2) J16721	(2) J16741
6			(2) J16608	(2) J16627	(2) J16647	(2) J16666	(2) J16686	(2) J16704	(2) J16722	(2) J16742
FULL FINISHED HEX NUTS	(10) J16800	(10) J16801	(10) J16802	(10) J16803	(10) J16804	(5) J16805	(5) J16806	(2) J16807	(2) J16808	(2) J16809

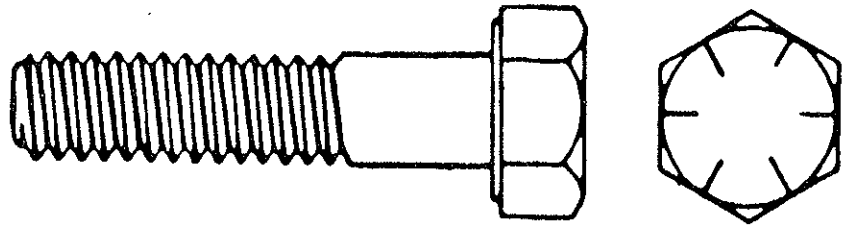

GRADE 8

HEX HEAD (PLATED) CAP SCREWS

USS COARSE THREAD

DIAMETER LENGTH	1/4-20	5/16-18	3/8-16	7/16-14	1/2-13	9/16-12	5/8-11	3/4-10	7/8-9	1-8	1 1/8-7	1 1/4-7	1 1/2-6
1/2	(10) J27000	(10) J27020	(10) J27040										
5/8	(10) J27001												
3/4	(10) J27002	(10) J27021	(10) J27041	(10) J27060	(10) J27079								
1	(10) J27003	(10) J27022	(10) J27042	(10) J27061	(10) J27080	(5) J27099	(5) J27120	(5) J27137					
1 1/4	(10) J27004	(10) J27023	(10) J27043	(10) J27062	(10) J27081	(5) J27100	(5) J27121	(5) J27138					
1 1/2	(10) J27005	(10) J27024	(10) J27044	(10) J27063	(10) J27082	(5) J27101	(5) J27122	(5) J27140	(2) J27155	(2) J27173			
1 3/4	(10) J27006	(10) J27025	(10) J27045	(10) J27064	(10) J27083	(5) J27102	(5) J27123	(2) J27141	(2) J27156	(2) J27174			
2	(10) J27007	(10) J27026	(10) J27046	(10) J27065	(10) J27084	(5) J27103	(5) J27124	(2) J27142	(2) J27160	(2) J27175	(2) J27188	(2) J27199	
2 1/4	(10) J27008	(10) J27027	(10) J27047	(5) J27066	(5) J27085	(5) J27104	(5) J27125	(2) J27143	(2) J27161	(2) J27176	(2) J27189	(2) J27200	
2 1/2	(10) J27009	(10) J27028	(5) J27048	(5) J27067	(5) J27086	(5) J27105	(5) J27126	(2) J27144	(2) J27162	(2) J27177	(2) J27190	(2) J27201	
2 3/4	(10) J27010	(10) J27029	(5) J27049	(5) J27068	(5) J27087	(5) J27106	(5) J27127	(2) J27145	(2) J27163	(2) J27178	(2) J27191	(2) J27202	
3	(10) J27011	(10) J27030	(5) J27050	(5) J27069	(5) J27088	(5) J27107	(5) J27128	(2) J27146	(2) J27164	(2) J27179	(2) J27192	(2) J27203	
3 1/2	(5) J27012	(5) J27031	(5) J27051	(5) J27071	(5) J27090	(2) J27109	(2) J27130	(2) J27148	(2) J27166	(2) J27181	(2) J27193	(2) J27204	
4	(5) J27013	(5) J27032	(5) J27052	(5) J27073	(5) J27092	(2) J27111	(2) J27132	(2) J27150	(2) J27168	(2) J27183	(2) J27194	(2) J27205	
4 1/2	(5) J27014	(5) J27033	(5) J27053	(5) J27074	(5) J27093	(2) J27112	(2) J27133	(2) J27151	(2) J27169	(2) J27184	(2) J27195	(2) J27206	
5	(5) J27015	(5) J27034	(5) J27054	(5) J27075	(5) J27094	(2) J27113	(2) J27134	(2) J27152	(2) J27170	(2) J27185	(2) J27196	(2) J27207	
5 1/2	(5) J27016	(5) J27035	(5) J27055	(5) J27076	(5) J27095	(2) J27114	(2) J27135	(2) J27153	(2) J27171	(2) J27186	(2) J27197	(2) J27208	
6	(5) J27017	(5) J27036	(5) J27056	(5) J27077	(5) J27096	(2) J27115	(2) J27136	(2) J27154	(2) J27172	(2) J27187	(2) J27198	(2) J27209	
FULL FINISHED HEX NUTS	(10) J27500	(10) J27501	(10) J27502	(10) J27503	(10) J27504	(5) J27505	(5) J27506	(5) J27507	(2) J27508	(2) J27509	(2) J27510	(2) J27511	(2) J27513

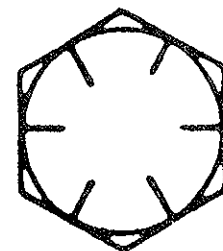
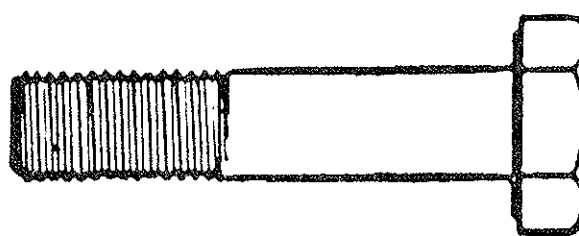

GRADE 8

HEX HEAD (PLATED)
CAP SCREWS

SAE FINE THREAD

DIAMETER LENGTH	1/4-28	5/16-24	3/8-24	7/16-20	1/2-20	9/16-18	5/8-18	3/4-16	7/8-14	1-14			
1/2	(10) J27550	(10) J27570	(10) J27590										
5/8	(10) J27551												
3/4	(10) J27552	(10) J27571	(10) J27591	(10) J27610	(10) J27630								
7/8	(10) J27553												
1	(10) J27554	(10) J27572	(10) J27592	(10) J27611	(10) J27631	(5) J27647	(5) J27661	(2) J27675					
1 1/4	(10) J27555	(10) J27573	(10) J27593	(10) J27612	(10) J27632	(5) J27648	(5) J27662	(2) J27676					
1 1/2	(10) J27556	(10) J27574	(10) J27594	(10) J27613	(10) J27633	(5) J27649	(5) J27663	(2) J27677					
1 3/4	(10) J27557	(10) J27575	(10) J27595	(10) J27614	(10) J27634	(5) J27650	(5) J27664	(2) J27678					
2	(10) J27558	(10) J27576	(10) J27596	(10) J27615	(10) J27635	(5) J27651	(5) J27665	(2) J27679					
2 1/4	(5) J27559	(5) J27577	(5) J27597	(5) J27616	(5) J27636	(5) J27652	(5) J27666	(2) J27680					
2 1/2	(5) J27560	(5) J27578	(5) J27598	(5) J27617	(5) J27637	(5) J27653	(5) J27667	(2) J27681					
2 3/4	(5) J27561	(5) J27579	(5) J27599	(5) J27618	(5) J27638	(5) J27654	(5) J27668	(2) J27682					
3	(5) J27562	(5) J27580	(5) J27600	(5) J27619	(5) J27639	(5) J27655	(5) J27669	(2) J27683					
3 1/2	(5) J27563	(5) J27581	(5) J27601	(5) J27621	(5) J27641	(2) J27656	(2) J27670	(2) J27684					
4	(5) J27564	(5) J27582	(5) J27602	(5) J27623	(5) J27643	(2) J27657	(2) J27671	(2) J27685					
4 1/2	(5) J27565	(5) J27583	(5) J27603	(5) J27624	(5) J27644	(2) J27658	(2) J27672	(2) J27686					
5	(5) J27566	(5) J27584	(5) J27604	(5) J27625	(5) J27645	(2) J27659	(2) J27673	(2) J27687					
6	(5) J27567	(5) J27585	(5) J27605	(5) J27626	(5) J27646	(2) J27660	(2) J27674	(2) J27688					
FULL FINISHED HEX NUTS	(10) J27800	(10) J27801	(10) J27802	(10) J27803	(10) J27804	(5) J27805	(5) J27806	(5) J27807					

ALLOY SOCKET HEAD CAP SCREWS HEAT TREATED

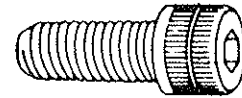

DIAMETER LENGTH	6-32	8-32	10-24	10-32	1/4-20	5/16-18	3/8-16	1/2-13		
	1/4	J29200	J29210							
3/8	J29201	J29211	J29221	J29241	J29261	J29281				
1/2	J29202	J29212	J29222	J29242	J29262	J29282	J29302			
5/8	J29203	J29213	J29223	J29243	J29263	J29283	J29303			
3/4	J29204	J29214	J29224	J29244	J29264	J29284	J29304	J29324		
7/8	J29205	J29215	J29225	J29245	J29265	J29285	J29305	J29325		
1	J29206	J29216	J29226	J29246	J29266	J29286	J29306	J29326		
1-1/4		J29217	J29227	J29247	J29267	J29287	J29307	J29327		
1-1/2		J29818	J29228	J29248	J29268	J29288	J29308	J29328		
1-3/4			J29229	J29249	J29269	J29289	J29309	J29329		
2			J29230	J29250	J29270	J29290	J29310	J29330		
2-1/4					J29271	J29291	J29311	J29331		
2-1/2					J29272	J29292	J29312	J29332		
2-3/4					J29273	J29293	J29313	J29333		
3					J29274	J29294	J29314	J29334		
3-1/2								J29335		
4								J29336		

SOCKET HEAD CAP SCREWS FLAT HEAD

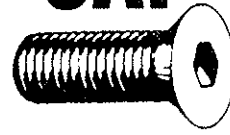

HEAT TREATED ALLOY STEEL

DIAMETER LENGTH	8-32	10-24	10-32	1/4-20	5/16-18	3/8-16	1/2-13		
	3/8	J29001	J29011	J29031	J29051				
1/2	J29002	J29012	J29032	J29052	J29072	J29092			
5/8	J29003	J29013	J29033	J29053	J29073	J29093			
3/4	J29004	J29014	J29034	J29054	J29074	J29094			
1	J29006	J29016	J29036	J29056	J29076	J29096	J29116		
1-1/4		J29017	J29037	J29057	J29077	J29097	J29117		
1-1/2		J29018	J29038	J29058	J29078	J29098	J29118		
1-3/4				J29059	J29079	J29099	J29119		
2				J29060	J29080	J29100	J29120		
2-1/4					J29081	J29101	J29121		
2-1/2					J29082	J29102	J29122		
2-3/4						J29103	J29123		
3						J29104	J29124		

SOCKET SET SCREWS

CUP POINT



HEAT TREATED ALLOY STEEL

DIAMETER LENGTH	8-32	10-24	10-32	1/4-20	5/16-18	3/8-16	1/2-13		
1/8	J29600								
3/16	J29601	J29621	J29641	J29661					
1/4	J29602	J29622	J29642	J29662	J29682	J29702			
5/16	J29603	J29623	J29643	J29663	J29683	J29703			
3/8	J29604	J29624	J29644	J29664	J29684	J29704	J29724		
7/16		J29625	J29645	J29665	J29685	J29705	J29725		
1/2	J29606	J29626	J29646	J29666	J29686	J29706	J29726		
5/8	J29608	J29628	J29648	J29668	J29688	J29708	J29728		
3/4	J29610	J29630	J29650	J29670	J29690	J29710	J29730		
7/8	J29612	J29632	J29652	J29672	J29692	J29712	J29732		
1	J29614	J29634	J29654	J29674	J29694	J29714	J29734		
1-1/4		J29635	J29655	J29675	J29695	J29715	J29735		
1-1/2				J29676	J29696	J29716	J29736		
1-3/4				J29677	J29697	J29717	J29637		
2				J29678	J29698	J29718	J29738		
2-1/2							J29739		
3							J29740		

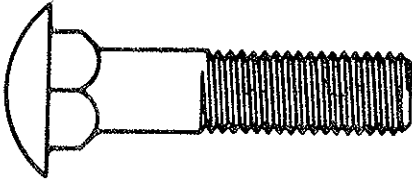

CARRIAGE BOLTS

ZINC PLATED

DIAMETER LENGTH	1/4-20	5/16-18	3/8-16	7/16-14	1/2-13	9/16-2	5/8-11	3/4-10	7/8-9	1-8		
1/2												
3/4	J20002											
1	J20003	J20022										
1-1/4				J20060								
1-1/2	J20005	J20024	J20044									
1-3/4												
2	J20007	J20026	J20046		J20064							
2-1/4	J20008											
2-1/2	J20009	J20028	J20048									
2-3/4												
3	J20011	J20030	J20050									
3-1/4												
3-1/2		J20032	J20052									
4	J20015	J20034	J20054									
4-1/2												
5			J20056									
5-1/2												
6	J20019	J20038										

MACHINE SCREWS

PLATED

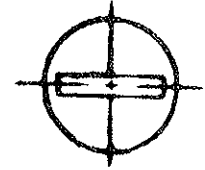

SLOTTED ROUND HEAD

PACKAGE QUANTITY 25

DIAMETER LENGTH	4-40	6-32	8-32	10-24	10-32	12-24	1/4-20	5/16-18	3/8-16			
1/4	J31000	J31015	J31030	J31045	J31060							
3/8	J31001	J31016	J31031		J31061		J31090					
1/2	J31002	J31017	J31032	J31046	J31062	J31076	J31091	J31110				
5/8		J31018	J31033	J31047	J31063		J31092					
3/4		J31019	J31034	J31048	J31064	J31077	J31093	J31111				
7/8			J31035									
1		J31020	J31036	J31049	J31065	J31078	J31094	J31112				
1-1/4		J31021	J31037	J31050	J31066	J31079	J31095	J31113				
1-1/2		J31022	J31038	J31051	J31067	J31080	J31096	J31114				
1-3/4		J31023	J31039	J31052	J31068		J31097					
2		J31024	J31040	J31053	J31069		J31098	J31115				
2-1/2			J31041	J31054	J31070		J31099	J31116				
3			J31042	J31055			J31100	J31117				
3-1/2				J31056				J31118				
4				J31057			J31101	J31119				
5							J31102					
6							J31103					
MACHINE SCREW NUTS	J31142	J31143	J31144	J31145	J31146	J31150	J31147	J31148	J31149			

MACHINE SCREWS

PLATED

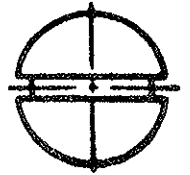
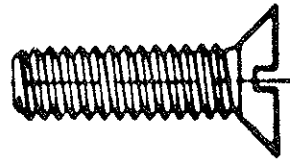

SLOTTED FLAT HEAD

PACKAGE QUANTITY 25

DIAMETER LENGTH	4-40	6-32	8-32	10-24	10-32	1/4-20	5/16-18	3/8-16				
1/4		J31165	J31180		J31210							
3/8		J31166	J31181	J31195		J31240						
1/2		J31167	J31182	J31196	J31212	J31241						
5/8		J31168	J31183			J31242						
3/4		J31169	J31184	J31197	J31213	J31243	J31255					
1		J31170	J31185	J31198	J31214	J31244	J31256	J31270				
1-1/4		J31171	J31186	J31199	J31215	J31245	J31257	J31271				
1-1/2		J31172	J31187	J31200	J31216	J31246	J31258	J31272				
1-3/4			J31188	J31201		J31247						
2		J31173	J31189	J31202	J31217	J31248	J31259					
2-1/2			J31190	J31203		J31249	J31260					
3			J31191	J31204		J31250	J31261					
3-1/2				J31205		J31251	J31262					
4				J31206		J31252	J31263					
5												
6												
MACHINE SCREW NUTS	J31142	J31143	J31144	J31145	J31146	J31147	J31148	J31149				

SHEET METAL SCREWS

PLATED

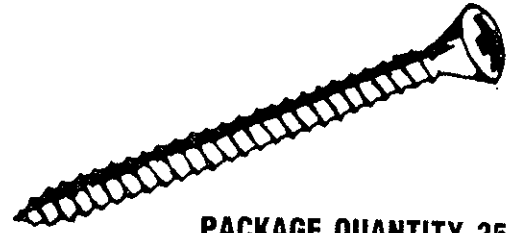

OVAL HEAD PHILLIPS

PACKAGE QUANTITY 25

DIAMETER LENGTH	6	8 w-6 head	8	10 w-6 head	10 w-8 head	10	12 w-8 head						
3/8	J77371	J77386	J77401										
1/2	J77372	J77387	J77402		J77430	J77445							
5/8	J77373	J77388	J77403	J77415	J77431	J77446							
3/4	J77374	J77389	J77404	J77416	J77432	J77447	J77461						
7/8	J77375	J77390	J77405	J77417		J77448							
1	J77376	J77391	J77406	J77418	J77433	J77449							
1-1/4	J77377	J77392	J77407	J77419	J77434	J77450	J77462						
1-1/2		J77393	J77408	J77420	J77435	J77451							
1-3/4		J77394		J77421	J77436	J77452							
2		J77395			J77437	J77453	J77463						

SHEET METAL SCREWS

PLATED

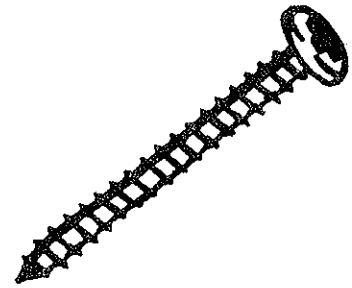

PAN HEAD PHILLIPS

PACKAGE QUANTITY 25

DIAMETER LENGTH	4	6	8	10	12	14							
1/4		J 77296											
3/8		J 77297	J 77306	J 77320									
1/2	J 77290	J 77298	J 77307	J 77321	J 77335								
5/8		J 77299	J 77308	J 77322	J 77336	J 77346							
3/4		J 77300	J 77309	J 77323	J 77337	J 77347							
7/8			J 77310	J 77324	J 77338								
1			J 77311	J 77325	J 77339	J 77348							
1-1/4			J 77312	J 77326	J 77340	J 77349							
1-1/2			J 77313	J 77327		J 77350							
1-3/4				J 77328		J 77351							
2						J 77352							
2 1/2				J 77331									

SHEET METAL SCREWS

PLATED

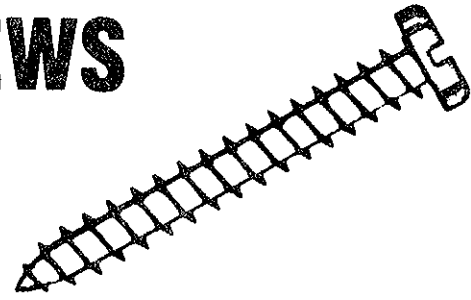

PAN HEAD SLOTTED

PACKAGE QUANTITY 25

DIAMETER LENGTH	4	6	8	10	12	14							
	1/4	J 77000	J 77006	J 77020									
3/8	J 77001	J 77007	J 77021	J 77035									
1/2	J 77002	J 77008	J 77022	J 77036	J 77055	J 77070							
5/8	J 77003	J 77009	J 77023	J 77037	J 77056	J 77071							
3/4	J 77004	J 77010	J 77024	J 77038	J 77057	J 77072							
7/8		J 77011	J 77025	J 77039	J 77058	J 77073							
1		J 77012	J 77026	J 77040	J 77059	J 77074							
1-1/4			J 77027	J 77041	J 77060	J 77075							
1-1/2			J 77028	J 77042	J 77061	J 77076							
1-3/4			J 77029	J 77043	J 77062	J 77077							
2			J 77030	J 77044	J 77063	J 77078							
2-1/2				J 77045		J 77079							
3				J 77046		J 77080							

SHEET METAL SCREWS

PLATED

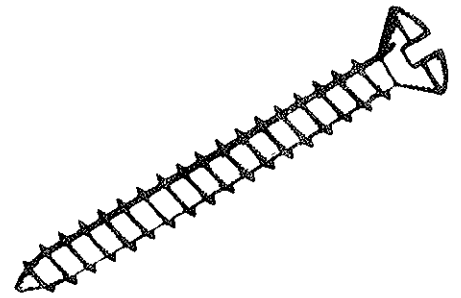

OVAL HEAD SLOTTED

PACKAGE QUANTITY 25

DIAMETER LENGTH	6	8	10	12	14					
	1/2	J77095	J77105	J77115	J77125					
3/4	J77097	J77107	J77117	J77126	J77135					
1	J77098	J77109	J77118	J77128	J77137					
1-1/4		J77110	J77119	J77129	J77138					
1-1/2			J77120	J77130	J77139					
2					J77140					

SHEET METAL SCREWS

PLATED

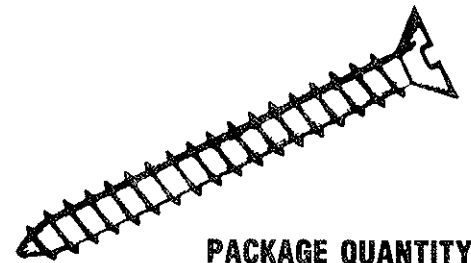

FLAT HEAD SLOTTED

PACKAGE QUANTITY 25

DIAMETER LENGTH	8	10	12	14						
	1/2	J77165	J77175	J77190	J77200					
3/4	J77166	J77176	J77191	J77201						
7/8	J77167	J77177								
1	J77168	J77178	J77192	J77202						
1-1/4		J77179	J77193	J77203						
1-1/2		J77180	J77194	J77204						
2		J77181		J77205						
2-1/2				J77206						

SHEET METAL SCREWS

PLATED

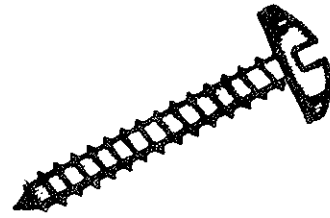

TRUSS HEAD SLOTTED

PACKAGE QUANTITY 25

DIAMETER LENGTH	6	8	10	12	14					
3/8	J77225	J77240								
1/2	J77226	J77241	J77251							
5/8		J77242	J77252	J77261						
3/4	J77227	J77243	J77253	J77262	J77271					
1		J77244	J77254	J77263	J77272					
1-1/2		J77245	J77255							

SHEET METAL SCREWS

PHILLIPS ROUND WASHER HEAD



PACKAGE QUANTITY 25

DIAMETER LENGTH	PLATED			PHOSPHATE OIL						
	8	10		8	10					
3/8		J77495			J77520					
7/16	J77485			J77510						
1/2	J77486	J77496		J77511	J77521					
3/4	J77487	J77497		J77512	J77522					
1	J77488	J77498		J77513	J77523					
1-1/4	J77489			J77514						
1-1/2	J77490	J77499		J77515	J77524					

SHEET METAL SCREWS

PLATED

SLOTTED HEX/WASHER HEAD

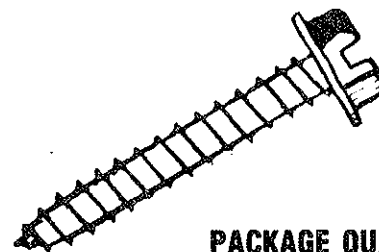

PACKAGE QUANTITY 50

DIAMETER LENGTH	8	10	12	14									
	3/8	J77625											
1/2	J77626	J77636											
5/8	J77627												
3/4	J77628	J77638	J77650	J77665									
7/8													
1	J77629	J77639	J77651	J77667									
1-1/4	J77630	J77640	J77652	J77668									
1-1/2			J77653	J77669									
2			J77655	J77671									

HEX HEAD

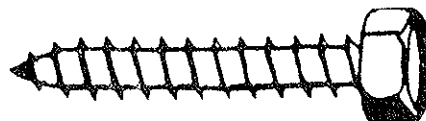

PACKAGE QUANTITY 25

DIAMETER LENGTH	8	10	12	14	5/16	3/8							
	3/8	J77550	J77560										
1/2	J77551	J77561	J77570	J77580	J77590								
5/8			J77571	J77581									
3/4	J77552	J77562	J77572	J77582	J77591								
7/8			J77573										
1	J77553	J77563	J77574	J77583	J77592	J77600							
1-1/4					J77593	J77601							
1-1/2				J77585	J77594	J77602							
2													

PLATED

FLAT WASHERS

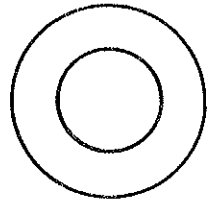

SAE

PART #	SIZE	ID	OD	GAUGE	PKG. QTY.
J37251	#6	5/32"	3/8"	3/64"	25
J37252	#8	3/16"	7/16"	3/64"	25
J37253	#10	7/32"	1/2"	1/16"	25
J37254	1/4"	9/32"	5/8"	1/16"	25
J37255	5/16"	11/32"	11/16"	1/16"	25
J37256	3/8"	13/32"	13/16"	1/16"	25
J37257	7/16"	15/32"	15/16"	1/16"	25
J37258	1/2"	17/32"	1-1/16"	3/32"	25
J37259	9/16"	19/32"	1-3/16"	3/32"	10
J37260	5/8"	21/32"	1-5/16"	3/32"	10
J37261	3/4"	13/16"	1-1/2"	1/8"	10
J37262	7/8"	15/16"	1-3/4"	1/8"	10
J37263	1"	1-1/16"	2"	1/8"	10

USS

PART#	SIZE	ID	OD	GAUGE	PKG. QTY.
J37201	#6	5/32"	7/16"	3/64"	25
J37202	#8	3/16"	1/2"	3/64"	25
J37203	#10	1/4"	9/16"	3/64"	25
J37204	1/4"	5/16"	3/4"	1/16"	25
J37205	5/16"	3/8"	7/8"	1/16"	25
J37206	3/8"	7/16"	1"	5/64"	25
J37207	7/16"	1/2"	1-1/4"	5/64"	25
J37208	1/2"	9/16"	1-3/8"	7/64"	25
J37209	9/16"	5/8"	1-1/2"	7/64"	10
J37210	5/8"	11/16"	1-3/4"	9/64"	10
J37211	3/4"	13/16"	2"	5/32"	10
J37212	7/8"	15/16"	2-1/4"	11/64"	10
J37213	1"	1-1/16"	2-1/2"	11/64"	10
J37215	1-1/4"	1-3/8"	3"	11/64"	10
J37216	1-3/8"	1-1/2"	3-1/4"	3/16"	10
J37217	1-1/2"	1-5/8"	3-1/2"	3/16"	10

FASTENERS

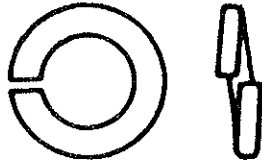

PLATED
**LOCK
WASHERS**

PART NUMBER	SIZE	PKG. QTY.
J37000	#6	10
J37001	#8	10
J37002	#10	10
J37004	1/4"	10
J37005	5/16"	10
J37006	3/8"	10
J37007	7/16"	10
J37008	1/2"	10
J37009	9/16"	10
J37010	5/8"	10
J37011	3/4"	10
J37012	7/8"	10
J37013	1"	10

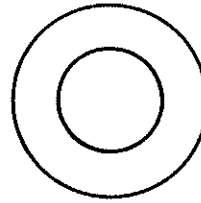

ZINC PLATED
**GRADE 8
FLAT WASHERS**

PART NUMBER	SIZE	PKG. QTY.
J37504	1/4"	25
J37505	5/16"	25
J37506	3/8"	25
J37507	7/16"	25
J37508	1/2"	25
J37509	9/16"	10
J37510	5/8"	10
J37511	3/4"	10
J37512	7/8"	10
J37513	1"	10

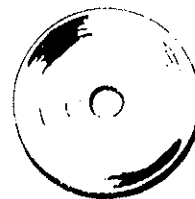

**FENDER
WASHERS**

J37300	1/4 I.D.—1 1/2 O.D.	10/pk
J37301	5/16 I.D.—1 1/2 O.D.	10/pk
J37302	3/8 I.D.—1 1/2 O.D.	10/pk
J37303	1/2 I.D.— 2 O.D.	10/pk

SQUARE KEY STOCK

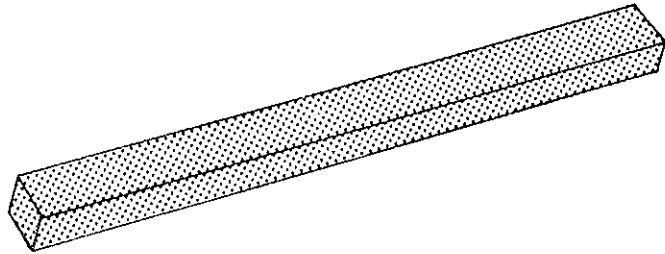

■ ALL 12" IN LENGTH

■ EASY TO CUT TO DESIRED LENGTH

■ PACKAGED SEPARATELY

PART NO.	SIZE
J80049	1/8 x 1/8
J80050	3/16 x 3/16
J80051	1/4 x 1/4
J80052	5/16 x 5/16
J80053	3/8 x 3/8
J80054	7/16 x 7/16
J80055	1/2 x 1/2
J80056	9/16 x 9/16
J80057	5/8 x 5/8
J80058	3/4 x 3/4
J80059	7/8 x 7/8
J80060	1 x 1

ACTUAL SIZE CROSS SECTION

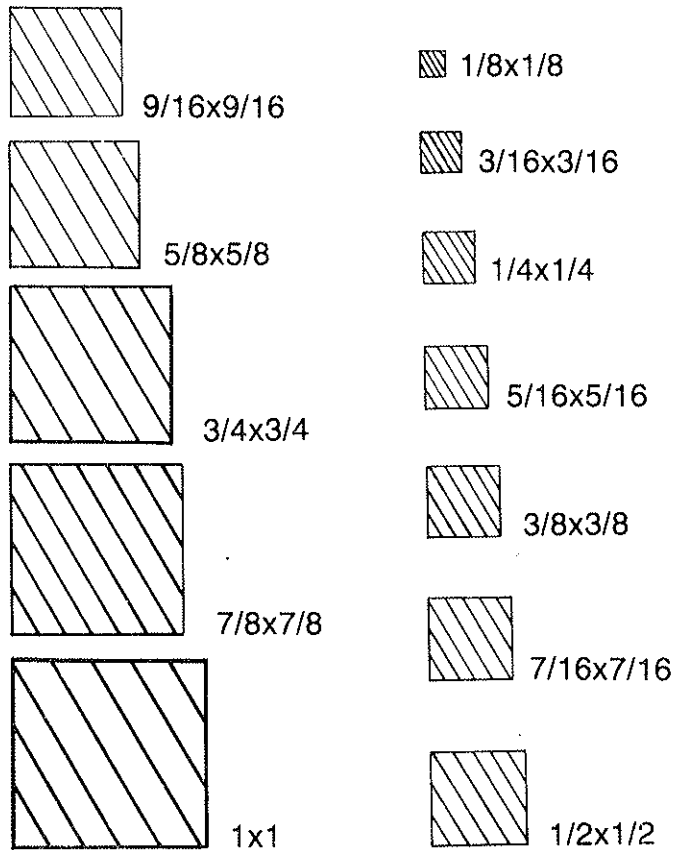

ROUND STOCK







PART NO.	DIAMETER
J80070	3/16
J80071	1/4
J80072	5/16
J80073	3/8
J80074	7/16
J80075	1/2
J80076	5/8
J80077	3/4
J80078	7/8
J80079	1

■ SPECIAL CARBON STEEL

■ ALL 36" IN LENGTH

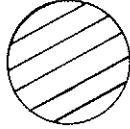
■ EASY TO CUT TO DESIRED LENGTH

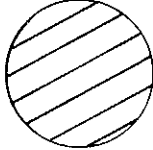
■ PACKAGED SEPARATELY

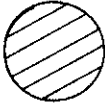
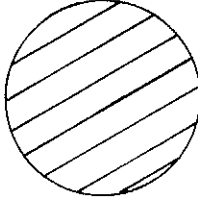
3/16 	3/8 	5/8 
1/4 	7/16 	3/4 
5/16 	1/2 	1 

ACTUAL SIZE CROSS SECTION

METRIC

		HEXAGON HEAD CAPSCREWS							DIN	
		STANDARD COARSE THREAD PITCH			THREADED TO THE HEAD				933/931	
GRADE: 8.8					TENSILE (PSI): 113,000-142,000					
Diameter(d)	M4	M5	M6	M7	M8	M10	M12	M16	M20	
Pitch	.70	.80	1.0	1.0	1.25	1.5	1.75	2.0	2.5	
Threads/Inch	36-1/4	31-3/4	25-1/2	25-1/2	20-1/4	17	14-1/2	12-3/4	10-1/4	
e	7.74	8.87	11.05	12.12	14.38	18.90	21.10	26.75	33.53	
k	2.8	3.5	4	5	5.5	7	8	10	13	
s	7	8	10	11	13	17	19	24	30	
Length (1)	DIN 933 FULL THREAD									
10	J65300	J65314	J65330		J65351					
12	J65301	J65315	J65331	J65560	J65352					
16	J65302	J65316	J65332	J65561	J65353					
20	J65303	J65317	J65333	J65562	J65354	J65377	J65403			
25	J65304	J65318	J65334	J65563	J65355	J65378	J65404	J65430		
30	J65305	J65319	J65335	J65564	J65356	J65379	J65405	J65431		
35	J65306	J65320	J65336	J65565	J65357	J65380	J65406	J65432		
40	J65307	J65321	J65337		J65358	J65381	J65407	J65433	J65456	
45		J65322	J65338		J65359	J65382	J65408	J65434	J65457	
50								J65435	J65458	
55								J65436	J65459	
60									J65460	
	PKG. 10					PKG. 5			PKG. 2	
Length(1)	DIN 931 PARTIAL THREAD									
50	J65308	J65323	J65339		J65360	J65383	J65409			
55		J65324	J65340		J65361	J65384	J65410			
60		J65325	J65341		J65362	J65385	J65411			
65		J65326	J65342		J65363	J65386	J65412			
70		J65327	J65343		J65364	J65387	J65413			
75			J65344		J65365	J65388	J65414			
80			J65345		J65366	J65389	J65415			
90					J65367	J65390	J65416			
100					J65368	J65391	J65417			
	PKG. 10		PKG. 5		PKG. 2					

METRIC

HEXAGON HEAD CAPSCREWS FINE THREAD

**DIN
960/961**

GRADE 8.8

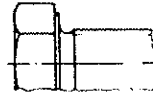
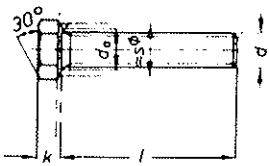

TENSILE (PSI):113,000 - 142,000

EXAMPLE: M8 x 1.00 x 20 DIN 961-8.8

Diameter (d)	M8	M8	M10			M12	M12	
Pitch	1.0	1.0	1.25			1.5	1.5	
Threads/Inch	25-1/2	25-1/2	20-1/4			17	17	
e	14.38	14.38	18.90			21.10	21.10	
k	5.5	5.5	7.0			8.0	8.0	
s	13	13	17			19	19	

Length (l)	PKG. 10	PKG. 5	PKG. 5			PKG. 5	PKG. 2	
10	J65500							
20	J65501		J65516			J65540		
25	J65502		J65517			J65541		
30	J65503		J65518			J65542		
35	J65504		J65519			J65543		
40	J65505		J65520			J65544		
45	J65506		J65521			J65545		
50		J65507	J65522			J65546		
55			J65523				J65547	
60			J65524				J65548	
65							J65549	
70							J65550	
75							J65551	
80							J65552	
90							J65553	
100							J65554	

**Sizes above line - Full Thread DIN 961
Sizes below line - Partial Thread DIN 960**

FASTENERS

METRIC NUTS

METRIC THREAD PITCH			
Diameter	Standard	FINE	X FINE
M3	0.50		
M4	0.70		
M5	0.80		
M6	1.00		
M7	1.00		
M8	1.25	1.00	
M10	1.50	1.25	1.00
M12	1.75	1.50	1.25
M14	2.00	1.50	1.25
M16	2.00	1.50	1.25

HEXAGON NUTS

GRADE 8.8

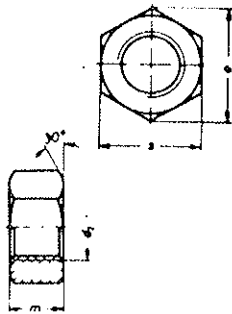

DIN 439/936

COARSE	
SIZE	PART NO.
M3	J65590
M4	J65591
M5	J65592
M6	J65593
M7	J65575
M8	J65594
M10	J65595
M12	J65596
M16	J65597
M20	J65599
Pkg. 10	

FINE	
SIZE	PART NO.
M8 x 1.00	J65603
M10 x 1.25	J65604
M12 x 1.50	J65605
Pkg. 5	

M 4-6 - DIN 439 M 8 & Up - DIN 936

HEXAGON JAM NUTS

GRADE 8.8

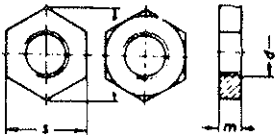

DIN 936 DIN 439

COARSE	
SIZE	PART NO.
M4	J65620
M5	J65621
M6	J65622
M8	J65623
M10	J65624
M12	J65625

Pkg. 10

FINE	
SIZE	PART NO.
M8 x 1.00	J65629
M10 x 1.25	J65630
M12 x 1.50	J65631

NYLON LOCKING NUTS

GRADE 8.8

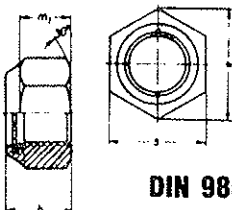

DIN 985

BRIGHT ZINC PLATED

COARSE	
SIZE	PART NO.
M3	J65640
M4	J65641
M5	J65642
M6	J65643
M8	J65644
M10	J65645
M12	J65646

Pkg. 10

FINE	
SIZE	PART NO.
M8 x 1.00	J65650
M10 x 1.25	J65651
M12 x 1.50	J65652

METRIC WASHERS

ZINC PLATED

MILD STEEL

DIN 125

DIN 127

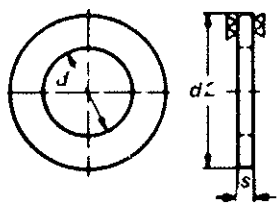
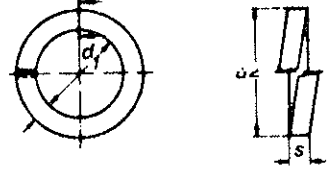
DIAMETER	D1	D2	S	PART NUMBER	DIAMETER	D1	D2	S	PART NUMBER
M3	3.2	7	0.5	(25) J65660	M3	3.1	6.2	0.8	(25) J65673
M4	4.3	9	0.8	(25) J65661	M4	4.1	7.6	0.9	(25) J65674
M5	5.3	10	1.0	(25) J65662	M5	5.1	9.2	1.2	(25) J65675
M6	6.4	12.5	1.6	(25) J65663	M6	6.1	11.8	1.6	(25) J65676
M7	7.4	14	1.6	(25) J65576	M7	7.1	12.8	1.6	(25) J65577
M8	8.4	17	1.6	(25) J65664	M8	8.1	14.8	2.0	(25) J65677
M10	10.5	21	2.0	(10) J65665	M10	10.2	18.1	2.2	(10) J65678
M12	13	24	2.5	(10) J65666	M12	12.1	21.1	2.5	(10) J65679
M14	15	28	2.5	(10) J65667	M14	14.2	24.1	3.0	(10) J65680
M16	17	30	3.0	(10) J65668	M16	16.2	27.4	3.5	(10) 65681
M20	21	37	3.0	(10) J65670	M20	20.2	33.6	4.0	(10) J65683
									
FLATWASHERS					LOCKWASHERS				



METRIC WASHERS & COTTER PINS

PACKAGE QUANTITY 10

ZINC PLATED

DIN 137

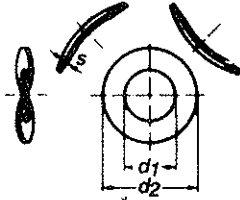
DIN 94

PART NUMBER	DIA.	D1	D2	S		PART NUMBER	DIA. D1	LENGTH L	MIN. C		
J65740	M3	3.2	6	.04		J65755	M1	12	1.6		
J65741	M4	4.3	9	0.5		J65756	M1.6	15	2.4		
J65742	M5	5.3	11	0.5		J65757	M1.6	20			
J65743	M6	6.4	12	0.5		J65758	M2	12	3.2		
J65744	M8	8.4	15	0.8		J65759	M2	18	3.2		
J65745	M10	10.5	21	1		J65760	M2	22	3.2		
J65746	M12	13	24	1.2		J65761	M3	15	5.1		
						J65762	M3	25	5.1		
						J65763	M3	40	5.1		
						J65764	M4	30	6.5		
						J65766	M5	45	8.0		
						J65767	M5	55	8.0		
 <p>SPRING WASHERS</p>						 <p>COTTER PINS</p>					

METRIC

CIR-CLIP LOCKRINGS

**DIN
6799**

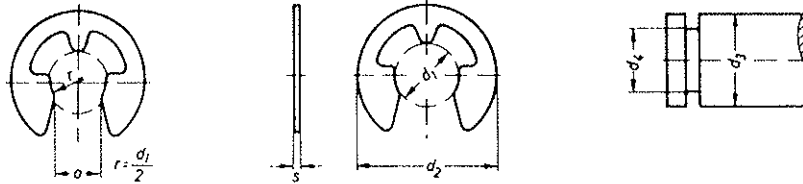

EXAMPLE: M4 DIN 6799

PART NO.	SIZE d1	d2	SHAFT DIAMETER d3		d4
			FROM	TO	
J65791	M4	9	5	7	4
J65792	M5	11	6	8	5
J65793	M6	12	7	9	6
J65795	M8	16	9	12	8
J65797	M10	20	11	15	10
J65798	M12	23	13	18	12
PKG. 10					

WOODRUFF KEYS

PART# J65771

DIN 6888

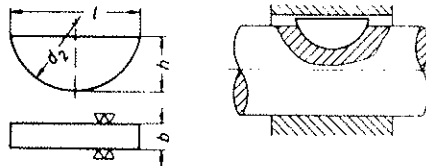

EXAMPLE: M3x5 DIN 6888

NOMINAL SIZE WIDTH x HEIGHT		LENGTH	SHAFT DIAMETER
b	h	l	
3	5	12.65	8-10
PKG. 5			

MACHINE SCREWS

METRIC

ZINC PLATED SLOTTED CHEESE HEAD

NICKEL PLATED PHILLIPS OVAL HEAD

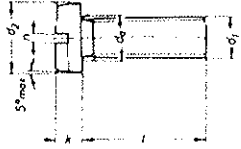
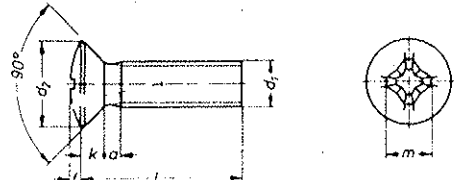
DIAMETER	M3	M4	M5	M6	DIAMETER	M3	M4	M5	M6
Pitch	.50	.70	.80	1.0	Pitch	.50	.70	.80	1.0
Threads/Inch	50-3/4	36-1/4	31-3/4	25-1/2	Threads/Inch	50-3/4	36-1/4	31-3/4	25-1/2
D2	5.5	7	8.5	10	D2	5.6	7.5	9.2	11.0
K	2.0	2.6	3.3	3.9	K	1.65	2.2	2.5	3
N	.80	1.0	1.2	1.6	N	3.1	4.5	5.3	6.8
LENGTH IN mm	PART NUMBERS				LENGTH IN mm	PART NUMBERS			
6	J65850	J65860	J65872		6	J65923	J65931		
8	J65851	J65861	J65873	J65884	8	J65924	J65932	J65942	
10	J65852	J65862	J65874	J65885	10	J65925	J65933	J65943	J65954
12	J65853	J65863	J65875	J65886	12	J65926	J65934	J65944	J65955
16	J65854	J65864	J65876	J65887	16	J65927	J65935	J65945	J65956
20	J65855	J65865	J65877	J65888	20	J65928	J65936	J65946	J65957
25		J65866	J65878	J65889	25		J65937	J65947	J65958
30			J65879	J65890	30			J65948	J65959
35				J65891	35				J65960
DIN 84	PAN HEAD				DIN 966				
GRADE 4.8					GRADE 4.8				
PKG. 10					PKG. 10				

METRIC MACHINE SCREWS

NICKEL PLATED

“PHILLIPS” FILLISTER HEAD

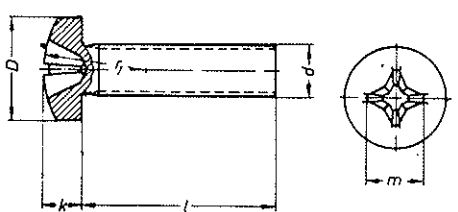
DIAMETER	M3	M4	M5	M6								
Pitch	.50	.70	.80	1.0								
Threads/Inch	50 ³ / ₄	36 ¹ / ₄	31 ³ / ₄	25 ¹ / ₂								
D	6	8	10	12								
K	2.4	3.1	3.8	4.6								
M	3.1	4.6	5.3	6.8								
LENGTH	PART NUMBERS											
6	J65986	J65995										
8	J65987	J65996	J66008									
10	J65988	J65997	J66009	J66020								
12	J65989	J65998	J66010	J66021								
16	J65990	J65999	J66011	J66022								
20	J65992	J66001	J66013	J66024								
25		J66002	J66014	J66025								
30				J66026								
35				J66027								
DIN 7985												
GRADE 4.8												
PKG.10												

METRIC HEX HEAD FLANGE BOLTS & NUTS

Grade 10.9 • JIS B 1189 • Pitch 1.25

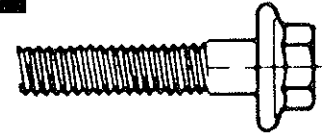

M6 • 10mm A.T.F.
14mm FLANG DIA.
1.00mm HD. HEIGHT*

J66210	M6x12mm	10/pk
J66211	M6x16mm	10/pk
J66212	M6x20mm	10/pk
J66213	M6x25mm	10/pk
J66214	M6x30mm	10/pk

M8 • 12mm A.T.F. 1.25
17.5mm FLANG DIA.
8mm HD. HEIGHT*

J66218	M8x12mm	10/pk
J66219	M8x16mm	10/pk
J66220	M8x20mm	10/pk
J66221	M8x25mm	10/pk
J66222	M8x30mm	10/pk
J66223	M8x35mm	10/pk

M10 • 14mm A.T.F. 1.50
21mm FLANG DIA.
10mm HD. HEIGHT*

J66230	M10x16mm	10/pk
J66231	M10x20mm	10/pk
J66232	M10x25mm	10/pk
J66233	M10x30mm	10/pk
J66235	M10x40mm	10/pk

* From under flange

HEX HEAD FLANGE NUTS

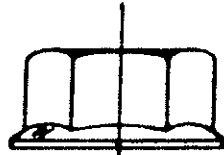

J5181	M5	50/pk
J66300	M6	10/pk
J66301	M8	10/pk
J66302	M10	10/pk

SMALL HEAD (JAPANESE) METRIC CAP SCREWS

Grade 8.8 • Pitch 1.25 • JIS B 1180 • Zinc Plated

M8 • 12mm A.T.F.
6.5mm Hd Thickness

M10 • 14mm A.T.F.
8mm Hd Thickness

M12 • 17mm A.T.F.
10mm Hd Thickness

PART#	SIZE	THRD	PKG QTY	PART#	SIZE	THRD	PKG QTY	PART#	SIZE	THRD	PKG QTY
J66131	M8x16	FULL	10	J66151	M10x20	FULL	5	J66172	M12x30	FULL	5
J66133	M8x20	FULL	10	J66152	M10x25	FULL	5	J66173	M12x40	PRTL	5
J66134	M8x25	FULL	10	J66153	M10x30	FULL	5	J66174	M12x50	PRTL	5
J66135	M8x30	FULL	10	J66154	M10x35	FULL	5	J66175	M12x60	PRTL	5
J66136	M8x35	FULL	10	J66155	M10x40	PRTL	5	J66176	M12x70	PRTL	5
J66137	M8x40	FULL	10	J66157	M10x50	PRTL	5				
J66139	M8x50	FULL	10	J66159	M10x60	PRTL	5				
J66141	M8x60	FULL	10	J66161	M10x70	PRTL	5				

A.T.F. (Across the Flat)

SMALL HEAD (JAPANESE) METRIC HEX NUTS

Grade 8 • Pitch 1.25

PART#	SIZE	A.T.F.	THK.	PKG QTY
J66200	M8	12mm	6.5mm	10
J66201	M10	14mm	8mm	10
J66202	M12	17mm	10mm	10

GM METRIC NUTS

J65013

Replaces 11502580
5mm x 11mm Hex
Nut, Acorn with Sealer, Self-
Threading
BLUE

General Motors
UNIT PACKAGE 25



J65053

Replaces 11502581
5mm x 13mm Hex
Nut, Acorn with Sealer, Self-Threading:
BLACK

General Motors Products, General Purpose
UNIT PACKAGE 10

J65014

Replaces 11501914
5mm x 13mm Hex
Nut, Acorn, Self-Threading:
BLUE

General Motors
UNIT PACKAGE 25

J65043

Replaces 11501927
5mm x 11mm O.D.
Blue

Push Nut, Round Flat Rear Seat Speaker:
General Motors **General Purpose**
UNIT PACKAGE 25

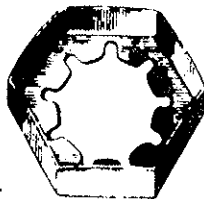

J65041

Replaces 11503698
6.3mm x 13mm O.D.
Retainer, Bolt:

General Motors Products **General Purpose**
UNIT PACKAGE 25



J65042

Replaces 11502517
16mm x 24mm Hex
Blue

Hex Nut, Hood Ornament:
General Motors **General Purpose**
UNIT PACKAGE 25



J65055

Replaces 11502759
10mm x 20mm O.D.
Nut, Push on Type:
General Motors
UNIT PACKAGE 25

J65015

Replaces 11502794
3.2mm x 9.5mm
ZINC PLATE
Push on Nut, Round:
General Motors
UNIT PACKAGE 25

J65016

Replaces 11501937
4mm x 11mm
Push on Nut, Round:
General Motors
UNIT PACKAGE 25

J65017

Replaces 1703731
8mm x 16mm
Push on Nut, Round:
General Motors
UNIT PACKAGE 25

J65018

Replaces 11502504
8mm x 16mm
ZINC PLATED
Push on Nut, Round:
General Motors
UNIT PACKAGE 25

J65019

Replaces 11501881
10mm x 19mm
Push on Nut, Round:
General Motors
UNIT PACKAGE 25

J65020

Replaces 11502737
12mm x 21mm
Push on Nut, Round:
General Motors
UNIT PACKAGE 25



J81-5361

Replaces 11503736
6mm x 13mm O.D.
Nut, Push Type:
ZINC
General Motors All Models:
UNIT PACKAGE 100



J80-5249

Replaces 11504119
14mm x 25mm O.D.
Nut, Bumper Rub Strips:
BLACK
General Motors 81
UNIT PACKAGE 100



J65071

Replaces 11501849 10 mm bolt size
Retainer (Metal), Push on type,
Bumper Bar Bolts:
BLUE
General Motors
UNIT PACKAGE 25

GM METRIC NUTS

J65021

Replaces 11501942
3.2mm x 8mm Hex
Stamped Hex Self-Threading Nut
with 11mm Integral Washer:
General Motors
UNIT PACKAGE 25

J65022

Replaces 11502549
4mm x 9mm
Stamped Hex Nut, Self-Threading,
with 15mm Integral Washer:
General Motors
UNIT PACKAGE 25

J65023

Replaces 11501855
5mm x 10mm Hex
Stamped Hex Lock Nut with
Sealer and 14mm Integral Washer:
General Motors
UNIT PACKAGE 25

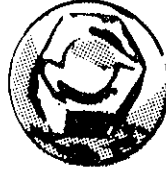

J65024

Replaces 11501814
5mm x 10mm Hex
Stamped Hex Lock Nut with 14mm
Integral Washer:
General Motors
UNIT PACKAGE 25

J65025

Replaces 11501835
5mm x 10mm Hex
Stamped Hex Heavy Duty Nut with 15mm
Integral Faceted Washer:
General Motors
UNIT PACKAGE 25

J65026

Replaces 11501932
5mm x 10mm Hex
Stamped Hex Nut, Self-Threading with
15mm Integral Flat Washer:
General Motors
UNIT PACKAGE 25

J65027

Replaces 11501047
5mm x 10mm Hex
Stamped Hex Lock Nut with 14mm
Integral Washer:
General Motors
UNIT PACKAGE 25

J65028

Replaces 11501851
6.3mm x 11mm Hex
Stamped Hex Nut, Self-Threading with
18mm Integral Faceted Washer and
Sealer:
General Motors
UNIT PACKAGE 25

J65029

Replaces 11501836
6.3mm x 11mm Hex
Stamped Hex Nut, Self-Threading with
18mm Integral Faceted Washer:
General Motors
UNIT PACKAGE 25



J65061

Replaces 11502540
4mm x 15mm
BLUE
Nut, Washer Face, Self-Threader:
General Motors
UNIT PACKAGE 25

J65030

Replaces 11502592
6.3mm x 11mm Hex
Stamped Hex Lock Nut with 18mm
Integral Flat Washer
General Motors
UNIT PACKAGE 25

J65031

Replaces 11501899
6.3mm x 11mm Hex
Stamped Hex Nut, Self-Threading with
24mm Integral Faceted Washer and
Sealer:
General Motors
UNIT PACKAGE 25

J65032

Replaces 11502546
6.3mm x 11mm Hex
Stamped Hex Nut, Self-Threading with
24mm Integral Faceted Washer:
General Motors
UNIT PACKAGE 25

GM METRIC NUTS



J65000

Replaces 11501014
Stud Size 6.3mm
HEX 11mm O.D. 18mm
Washer Type Metric Locknut:
General Motors
UNIT PACKAGE 25
BLACK



J65059

Replaces 470884
6.3mm
Blue
Nut, Locking Type, Bumper Filler Strip:
Chevette
UNIT PACKAGE 25



J65056

Replaces 11503691
6.3mmx18mm
O.D. Black
Stamped Hex Lock Nut With Integral
Multifaceted 18mm Washer
General Motors
UNIT PACKAGE 25



J65060

Replaces 11503700
4mmx9mm Hex
Dichromate
Nut, Hex Self Threader:
General Motors
UNIT PACKAGE 25
PLAIN STEEL



J65064

Replaces 11504109
5mmx10mm HEX
Nut, Self Threading with Sealer, Internal
Hex Drive, Center Hood Trim Molding:
Chevrolet and Oldsmobile
UNIT PACKAGE 10
BLACK



J80-5247

Replaces 477417
6mm x 1 x 11mm Hex
18mm Washer
Nut, Header Panel, Bumper
Filler, Windshield Wiper
Motor Pump:
General Motors 79
UNIT PACKAGE 100

GENERAL MOTORS METRIC HEX STAMPED NUTS SELF THREADING

J65009

Replaces 11502520
4mm x 9mm Hex
Hex Stamped Nut, Self Threading
BLUE
General Motors
UNIT PACKAGE 25

J65010

Replaces 11501793
5mm x 10mm Hex
Hex Stamped Nut, Self Threading
BLUE
General Motors
UNIT PACKAGE 25







J65011

Replaces 1150251
5mm x 13mm Hex
Hex Stamped Nut, Self Threading:
BLUE
General Motors
UNIT PACKAGE 25

J65012

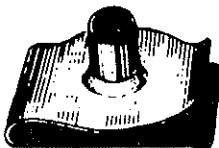
Replaces 11503417
6.3mm x 13mm Hex
Hex Stamped Nut, Self Threading:
BLUE
General Motors
UNIT PACKAGE 25

GM METRIC U-NUTS

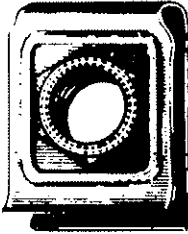
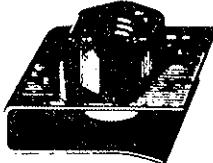
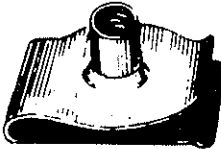
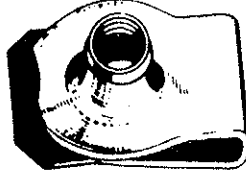
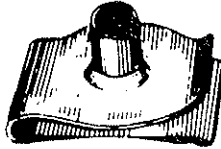
<p>J65033 Replaces 11500654 4mm x 0.7 Thread Pitch Nut, Extruded Type, Metric Short Throat Sheet Metal and Front End Assembly: BLUE General Motors UNIT PACKAGE 10</p> 	 <p>J65035</p>	 <p>J65036</p>
<p>J65034 Replaces 11500655 4mm x 0.7 Thread Pitch Nut, Extruded Type, Metric, Long Throat Sheet Metal and Front End Assembly BLUE General Motors UNIT PACKAGE 10</p> 	<p>Replaces 11500657 5mm x 0.8 Thread Pitch Nut, Extruded Type, Metric, Sheet Metal and Front End Assembly: BLUE General Motors UNIT PACKAGE 10</p>	<p>Replaces 11502785 6.3mm x 1.0 Thread Pitch Nut, Extruded Type, Metric, Self Locking Sheet Metal and Front End Assembly BLUE General Motors UNIT PACKAGE 10</p>
 <p>J65051 Replaces 11503455 8mm Blue Panel Range 2.0mm-5.0mm Nut Extruded Type, Metric, Sheet Metal & Front End Assembly: Bumper Strips and Bumper Guards: Chevrolet and Cadillac UNIT PACKAGE 10</p>	 <p>J65037 Replaces 1610890 6.3mm Nut, Metric, Plastic Headlamp: Cadillac (4 used per car) UNIT PACKAGE 5 BLUE</p>	 <p>J65038 Replaces 556307 10mm Nut, Metric, Gas Tank Retaining: General Motors Cars UNIT PACKAGE 5 BLACK</p>
 <p>J65054 Replaces 11503685 6.3mm BLUE Panel Range .80mm-4.00mm Nut, Extruded Type, Short Throat: General Motors UNIT PACKAGE 10</p>	 <p>J65062 Replaces 11503564 10mm 1.5mm-5mm Blue Panel Range U-Nut, Bumpers & General Usage: Chevrolet 'A' Bodied Cars UNIT PACKAGE 5</p>	 <p>J65068 Replaces 11503716 6mm x 1.0 Thread Pitch Nut, Extruded Type Metric, Sheet Metal and Front End Assembly GREEN General Motors UNIT PACKAGE 10</p>

GM METRIC U-NUTS

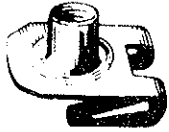

J65075

Replaces 371964-8mm Blue
Nut, Extruded Type,
Shock Absorber Ends:
General Motors
UNIT PACKAGE 10

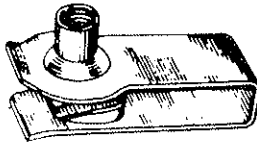

J65076

Replaces 11503715
6mm Long Throat
Nut, Extruded Type, Fenders, Shrouds
Radiator
BLACK
General Motors
UNIT PACKAGE 10



J65077

Replaces 11503719
Locking Type-6mm
Nut, Extruded Type, Fenders, Shrouds
Radiator:
PLAIN
General Motors
UNIT PACKAGE 10



J764319

Replaces 11500661
8 mm
Nut, Extruded Type, Long Throat,
Metric:
General Motors '77/.
UNIT PACKAGE 50



J78 4832

Replaces 347630
#8 Screw Size
Nut, Headlite and Grille:
General Motors
UNIT PACKAGE 100



J80 5216

Replaces 11504102
4.2mm
Nut J Type
G.M.
UNIT PACKAGE 100

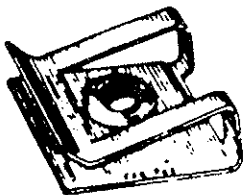

J86 6165

Replaces 14015876
Nut "U" Type. Screw Size M4.2-1.41
Panel Range 3.18-6.35mm
Black Finish.
G.M. & General Purpose
UNIT PACKAGE 100

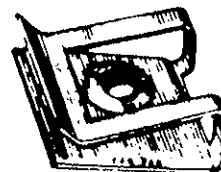

J86 6081

Replaces 11509236
U-Nut. Stamped
Screw Size 4.2 x 1.41
Panel Range 1.0mm - 1.6mm
G.M & Other General Purpose
UNIT PACKAGE 100

GM METRIC TORX

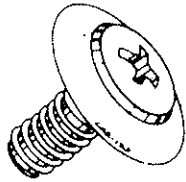

J845796

Replaces 20375022
Screw-encapsulated Phillips
6mm Steel Screw w/ Black
Nylon Cap 30mm OD
Door Skin to Frame
GM Fiero "P" Body
1984 - Up
UNIT PACKAGE 25

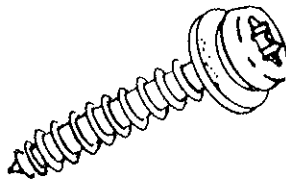

J86 6164

Replaces 11509604
Screw Torx Pan Head Tapping Type "AB"
With Washer. M6.3-1.89 x 25mm With
17mm Washer (1/4-17 x 1) Black Finish
G.M. & General Purpose
UNIT PACKAGE 50

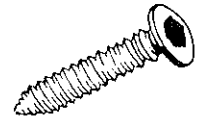

J65112

Replaces 11504647
4.2mm-1.41 x 20mm Torx Type
Screw (Chromed 302 Stainless Steel)
Pan Head Type 'AB' Self-Tapping
General Motors
UNIT PACKAGE 10



J65111

Replaces 11504477
4.2mm-1.41 x 20mm Torx Type
Screw (Chromed 302 Stainless Steel)
Oval Head Type 'AB' Self-Tapping:
General Motors
UNIT PACKAGE 10



J65110

Replaces 11504664
4.2mm-1.41 x 55mm Torx Type
Screw (Chromium Plated Oval Head)
Type 'AB' Self-Tapping
General Motors
UNIT PACKAGE 10

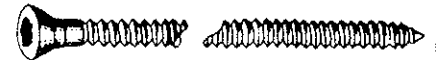

J65113

Replaces 11504654
4.2mm-1.41 x 40mm Torx Type
Screw (Chromed 302 Stainless Steel)
Oval Head Type 'AB' Self-Tapping:
General Motors
UNIT PACKAGE 10

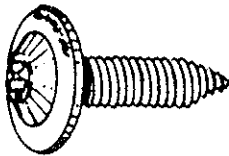

J86 6013

Bolt, Torx Washer Head 'CA' Point
M6 x 1 x 20mm w/ 18mm Dia.
Washer Head
Zinc Finish
G.M., General Purpos^e Body Bolt
UNIT PACKAGE 50

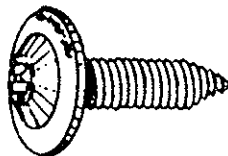

J86 6042

Bolt, Torx Washer Head.
'CA' Point M6 x 1.0 x 25mm
Washer Head Dia. 18mm
Zinc Plate. General Purpose.
Body Bolt.
UNIT PACKAGE 50

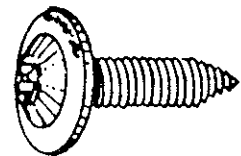

J86 6044

Bolt, Torx Washer Head.
'CA' Point M8 x 1.25 x 25mm
Washer Head Dia. 20mm
Zinc Plate. General Purpose.
Body Bolt.
UNIT PACKAGE 25

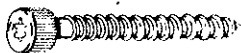

J835677

Replaces 14044408
4.5mm-1.41x20mm
Black
Screw Torx Drive, Knurled
Socket Head Dashpad
Retaining
Firebird and Camaro '82
UNIT PACKAGE 25

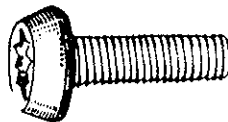

80-5147

8MM x 25MM
Grade 9.8
Bolt, Torx Type, Bumpers:
General Motors '79/.
UNIT PACKAGE 50

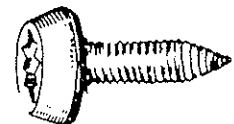

80-5278

Not Available from OEM
6mm - 1.0 x 20mm
Screw, Torx Type, Truss Head
Type CA Self Tapping
Plastic Inner Fender to Fender
G.M.
UNIT PACKAGE 50

GM METRIC BUMPER BOLTS

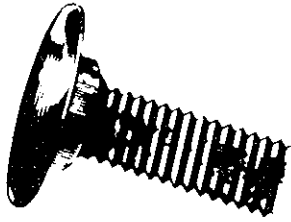

J65088

Replaces 11502479
8mm x 20mm
Bumper Bolt, Steel Capped,
Metric:
Pontiac and Other General Motors Cars
UNIT PACKAGE 10

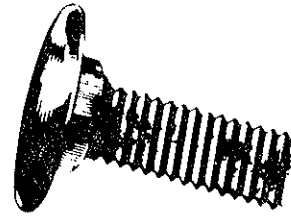

J65099

Replaces 11502480
8mm x 20mm
Bumper Bolt, Uncapped, Metric:
General Motors Cars
UNIT PACKAGE 10



J65108

Replaces 11503267
5mm-0.8 x 20mm
Bolt, Metric, Side Marker Lamp to
Bumper:
General Motors
UNIT PACKAGE 10

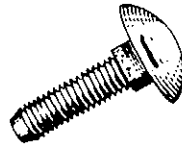

J65106

Replaces 11501911
6.3-100 x 20mm
Bolt, Bumper:
General Motors Cars
UNIT PACKAGE 10

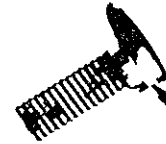

J85-5982

Replaces N800744-S, 14003784
Bumper Bolt, Stainless Steel Cap
M8 - 1.25 x 25mm
G.M. & Ford Various Models
UNIT PACKAGE 25

GM METRIC DOG POINT



J77-4452

Replaces 11500402
8mm X 1.25 X 25mm
Metric Taplite Thread Forming
Indented Hex Head Pilot Point
Bolt, 4037 Steel Case Hardened
w/15mm Conical (Toothed)
Washer
Phosphate

G.M. & General Purpose
UNIT PACKAGE 50



BLACK
YELLOW

J65001

Replaces 361940
6.3mm X 1.00 X 15mm Grade 9.8
Indented Hex Head Bolt, With
Conical
Washer and Nylon Patch:

General Motors
UNIT PACKAGE 10



BLACK

J65003

Replaces 11500402
8mm X 1.25 X 25mm
Metric Taplite Thread Forming
Indented Hex Head Pilot Point
Bolt, 4037
Steel Case Hardened w/Conical

General Motors
UNIT PACKAGE 5







J991413

Replaces N606690-S2
Bolt Indented Hex Head w/Dog
Point & Free Spinning Washer
M8-1.25 X 30mm w/22mm
Washers:
10mm Flat Dim.
Grade 9.8: Black Finish

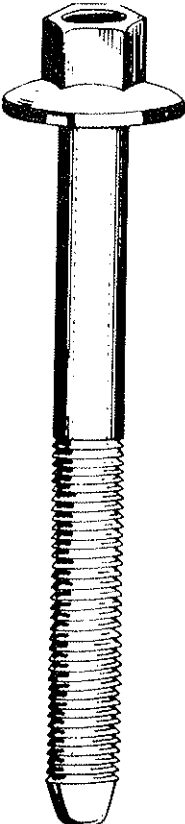
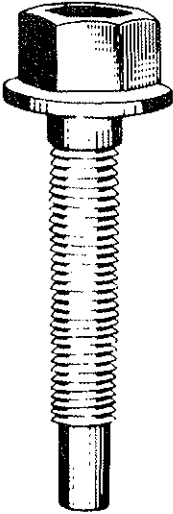
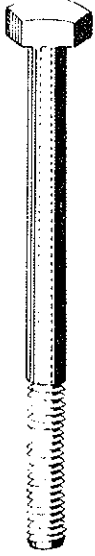
General Purpose: Ford Products
UNIT PACKAGE 25

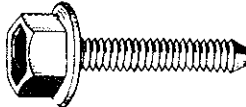
GM METRIC WASHER BOLTS

 <p>J65045 Replaces 11503407 12mm x 1.75 x 95mm BLACK Bolt, Radiator Support to Frame: General Motors UNIT PACKAGE 5</p>	 <p>J65067 Replaces 560877 10mm x 1.5 x 45mm Hex Washer Head Bolt with Dog Point: BLACK General Motors UNIT PACKAGE 5</p>	 <p>J65085 Replaces 11504023 6mmx65mm Hex Head Bolt: Metric General Motors UNIT PACKAGE 10 BLACK</p>
 <p>J65079 Replaces 11504501 8mmx1.25x30mm Bolt, Indented Hex Washer Head: General Motors UNIT PACKAGE 10 BLACK</p>	 <p>J65084 Replaces 11503785 6mm x 25mm Hex Washer Head Bolt: Metric GREEN General Motors UNIT PACKAGE 10</p>	 <p>J65080 Replaces 11504499 8mmx1.25x25mm Bolt, Indented Hex Washer Head: General Motors UNIT PACKAGE 10 BLUE</p>

GM METRIC CA POINT

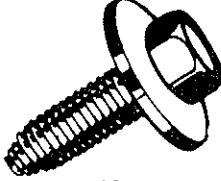
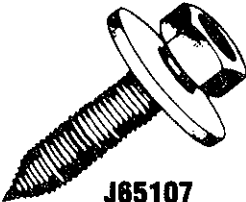
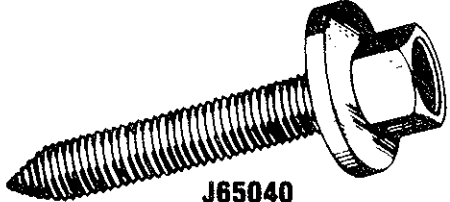
 <p>J65103 Replaces 11504493 6mm x 25mm Screw, Indented Hex Head with Loose 24mm Washer, CA Point; BLACK General Motors Cars UNIT PACKAGE 10</p>	 <p>J65107 Replaces 11502489 6.3mm x 25mm Indented Hex Head Tapping Screw with Loose 25mm Washer: General Motors UNIT PACKAGE 10</p>	 <p>J65040 Replaces 11501193 10mm x 40mm Screw Indented Hex Head with Loose 30mm Washer, CA Point GREEN General Motors Cars UNIT PACKAGE 5</p>
---	---	---

GM METRIC CA POINT

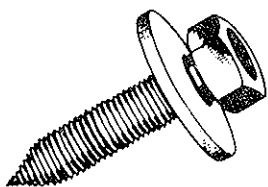

J65006
Replaces 11501102
8mmx1.25x25mm Grade 9.8
Indented Hex Head Bolt Type CA With
Conical Washer:
General Motors
UNIT PACKAGE 10
BLUE



J65046
Replaces 11501184
6.3mm x 40mm
Grade 9.8
Indented Hex Head Bolt with 17mm
Washer
BLUE
General Motors
UNIT PACKAGE 10

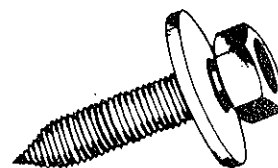

J65058
Replaces 365718
6.3mm x 25mm
BLACK
Indented Hex Head Bolt with Loose
23mm
Washer, CA Point
Chevette
UNIT PACKAGE 10

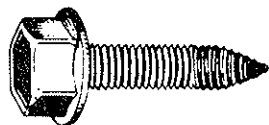

J65072
Replaces 11503616
6.3mmx25mm Black
Screw, Hex Washer Head:
General Motors
UNIT PACKAGE 10

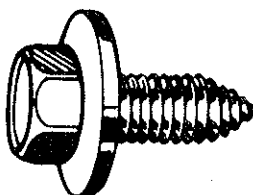

J65089
Replaces 11501188
8mm x 1-3/16
Screw, Indented Hex Head with
Loose 24mm Washer CA Point:
BLACK
General Motors
UNIT PACKAGE 10

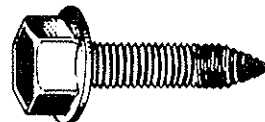

J65091
Replaces 11500970
8mm x 25mm
Indented Hex Washer Head Bolt:
BLACK
General Motors
UNIT PACKAGE 10

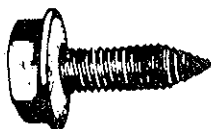

J65093
Replaces 11500969
8mm x 20mm
Indented Hex Washer Head Bolt
CA Point:
BLACK
General Motors
UNIT PACKAGE 10



J81-5344
Replaces 20083312
6mmx30mm
Hex, Washer Head Bolt, 'CA' Point,
Fenders and Shrouds:
General Motors '80/
UNIT PACKAGE 25

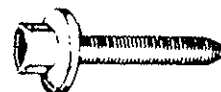

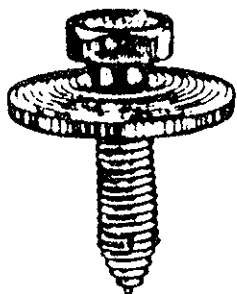

85-5984
Replaces 11505044
Indented Hex Head Bolt w/ Washer
'CA' Point M6-1 x 35mm w/ 17mm
Washer
G.M. & Other Makes
General Purpose
UNIT PACKAGE 50



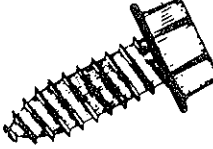
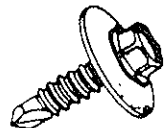
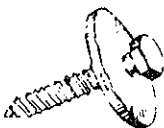
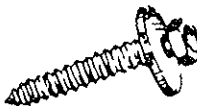

Part No.	Thread	Length	Washer O.D.
J65130	M8- 1.25	30mm	23.813mm
J65125	M8- 1.25	20mm	23.813mm
J65120	M6-1.0	25mm	17mm

UNIT PACKAGE 10

GM METRIC HEX SMS

 <p>J65092 Replaces 11500986 7.9mm x 16mm Indented Hex Washer Head Sheet Metal Screw, A Point: BLACK General Motors UNIT PACKAGE 10</p>	 <p>J65094 Replaces 11500961 6.3mm x 20mm Indented Hex Head Washer Head Bolt CA Point: General Motors UNIT PACKAGE 10</p>	 <p>J991445 Replaces 11501790 Screw Indented Hex Drill Screw w/Free Spinning Washer. Black Phosphate Finish M6.3-1.81 x 20mm: Hex Dia. 10mm Washer 24mm O.D. General; Purpose UNIT PACKAGE 50</p>
 <p>J79-5005 Replaces 11502449 4mm x 20mm Black Indented Hex Head Sheet Metal Screw w/ Attached 16mm Washer G.M. Cars, General Purpose UNIT PACKAGE 50</p>	 <p>J80-5141 Replaces 11500434 4.2mm x 20mm Black Hex Head Screw w/ 12mm Attached Washer G.M., General Purpose UNIT PACKAGE 50</p>	 <p>J86 6090 Replaces 11501842 Screw. Indented Hex Head Tapping, w/ Free Spinning Washer & Biwax Black Phosphate Finish M6.3 x 20mm w/ 12mm Washer 10mm Hex GM & General Purpose UNIT PACKAGE 50</p>

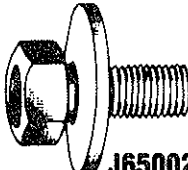
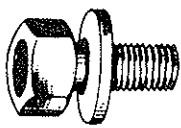
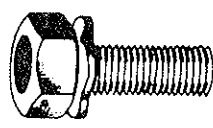
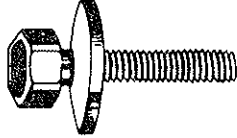
GM METRIC HEX FREE SPINNING WASHERS

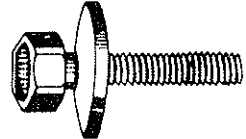
 <p>J65002 Replaces 11502820 8mmxl.25x16mm Grade 9.8 Indented Hex Head Bolt With Conical Washer: General Motors UNIT PACKAGE 10 BLACK</p>	 <p>J65004 Replaces 11501829 8mmxl.25x16mm Grade 9.8 Indented Hex Head Bolt With Conical Washer: General Motors UNIT PACKAGE 10 BLACK</p>	 <p>J65005 Replaces 11048281 8mmxl.25x18mm Grade 9.8 Indented Hex Head Bolt With Waved Spring Washer: General Motors UNIT PACKAGE 10 BLACK</p>
 <p>J65078 Replaces 11504303 6mmx25mm Bolt, Hex Head, with attached 17mm Free Spinning Washer: General Motors UNIT PACKAGE 10 BLACK</p>	 <p>J65115 (11503396) (11503483) (No.8)-4.2-1.41 x 20mm Phos. 7mm Hex Head Sems Screw GM Product "J", "X" Body All Models, Front End Bezel A/C System 12mm O.D. Washer UNIT PACKAGE 50</p>	 <p>J80-5141 Replaces 11500434 4.2mm x 20mm Hex Head Screw with 12mm Attached Washer: BLACK General Motors, General Purpose UNIT PACKAGE 50</p>

GM METRIC FLANGE NUTS



J65007

Replaces 11500747
6.3mm x 11mm Hex
Hex Nut, with Free Spinning
16mm Washer:
BLUE
General Motors
UNIT PACKAGE 25

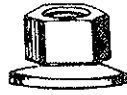

J65073

Replaces 11503752-6mm Green
Nut, with Free Spinning Toothed Washer:
General Motors
UNIT PACKAGE 10
GREEN

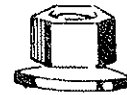

J65074

Replaces 11503753-6mm Green
Nut, with Free Spinning Washer:
General Motors
UNIT PACKAGE 10
PLAIN

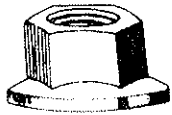

J65083

Replaces 11502609-8mm
Hex Washer Nut, Metric:
BLUE
General Motors
UNIT PACKAGE 10

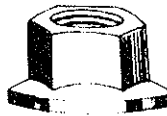

J65086

Replaces 11503745-6mm
Hex Flange Nut, General Usage:
GREEN
General Motors
UNIT PACKAGE 10



J65095

Replaces 11501106
6.3mm
Hex Nut, with Free Spinning
16mm Washer
BLUE
General Motors
UNIT PACKAGE 10

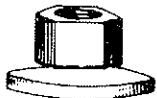

J65096

Replaces 11500371
6.3mm
Hex Nut, with Free Spinning
19mm Washer:
BLUE
General Motors
UNIT PACKAGE 10

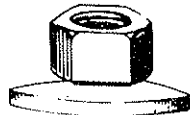

J65097

Replaces 11500401
8mm
Hex Nut, with Free Spinning
24mm Washer
PLAIN
General Motors
UNIT PACKAGE 10

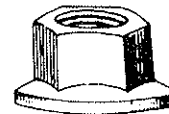

J65098

Replaces 11501850
10mm
Hex Nut, with 21mm Integral Washer:
PLAIN
General Motors
UNIT PACKAGE 10

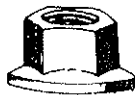

J65104











Replaces 11502811
8mm-1.25
Nut, Hex Lock Nut:
General Motors
UNIT PACKAGE 10

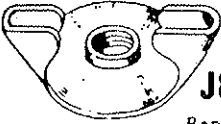

J65105

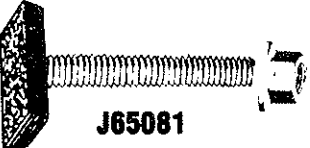
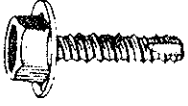
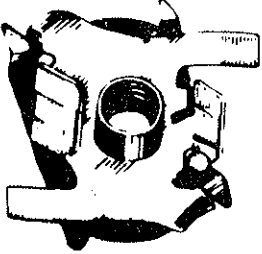
Replaces 11502812
10mm-1.50
Nut, Hex Lock Nut:
General Motors
UNIT PACKAGE 10

GM METRIC MISC.

 <p>J65049 Replaces 11502763 8mm BLUE Nut, Jack Handle Tie Down: General Motors Cars UNIT PACKAGE 10</p>	 <p>J65050 Replaces 11501818 8mm Nut, Air Cleaner: Buick UNIT PACKAGE 10</p>	 <p>J65087 Replaces 368216-8mm Nut, Spare Tire Hold Down: BLACK General Motors UNIT PACKAGE 5</p>
 <p>J65063 Replaces 11501909 7.5mm x 16mm and 6.3mm x 20.6mm BLUE Stud, Double End: Oldsmobile and Buick UNIT PACKAGE 5</p>	 <p>J82 5609 Replaces 14001197 6mm Air Cleaner Hold Down Wing Nut Olds, Pontiac, Chevrolet, G.M.C. Truck UNIT PACKAGE 25</p>	 <p>J65066 Replaces 11502623 4mmx-0.7 x 20mm BLUE Metric, Flat Head Phillips Machine Screw Pozi-Drive: BLACK General Motors UNIT PACKAGE 10</p>
 <p>J65069 Replaces 11502783 6.3mm x 35mm Screw, Phillips Oval Head Chrome Plated, Roof Luggage Rack Mounting: General Motors Cars UNIT PACKAGE 10</p>	 <p>J65081 Replaces 561258-6mm Tee Bolt and Nut Kit, Bumper Strips and End Attaching: BLACK-GREEN Oldsmobile UNIT PACKAGE 5</p>	 <p>J65082 Replaces 11501917 7.9mmx1.59x20mm Hex, Washer Head Bolt, Hi-Lo Thread, Grille and Fibre Glass Front End Members: Oldsmobile UNIT PACKAGE 10</p>
 <p>J65044 Replaces 371914 8mm Nut, Metric, Hood Leveling: BLACK General Motors UNIT PACKAGE 5</p>	 <p>J65100 Replaces 11500983 4mm x 11mm Screw, Sheet Metal, Hex Washer Head with Phillips Drive: ZINC General Motors UNIT PACKAGE 25</p>	 <p>J65102 Replaces 1609980 4mm x 25mm Screw, Pan Head Phillips Drive Marker Lights: BLACK Cadillac UNIT PACKAGE 10</p>
 <p>J65057 Replaces 560710 6.4mm Nut, Bumper Strips and Bumper Guards: PLAIN General Motors UNIT PACKAGE 10</p>	 <p>J65039 Replaces 368257 4.2mm x 1.41 x 55mm Headlamp Door and Bezel Screw, Pozi- Drive Oval Head with Attached Counter Sunk Washer: ZINC Chevrolet UNIT PACKAGE 10</p>	

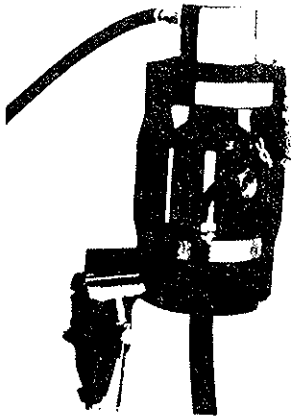

T-450 — PORTABLE
COLLO-CRIMP®

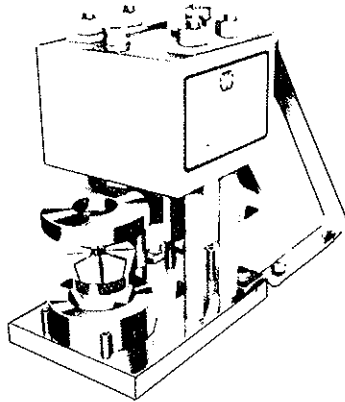

T-400 — COLLO-CRIMP® I

Hose Assembly System

Make custom factory-quality hose assemblies quickly, conveniently, and economically.

Economical • Versatile • Fast • Simple

T450 Weatherhead's all-new Portable Coll-O-Crimp hose assembly system. Now make custom, factory-quality hose assemblies in the field. Hand pump powered. Crimps 3/16" thru 1" I.D. rubber, thermoplastic or Teflon® hose.

T400 The "Standard" of the industry. Coll-O-Crimp I is the time proven "Mini-Factory" you can easily set up in your own shop. Crimps 3/16" thru 1 1/4" I.D. hose. NEW-now crimps H432 4 wire spiral, high pressure hydraulic hose, through 1" I.D.

Female swivel 45° tube elbow

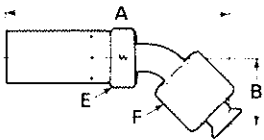

Hose I.D.	Pipe Size	Catalog Number	Thread Size	A	B	Hose Cut-Off Factor†	Hole Dia.	Hex E	Hex F
3/8	3/8	J06U ABS	3/4-20	3.17	.39	1-13/16	.245	11/16	11/16

Flareless tube rigid with nut and sleeve

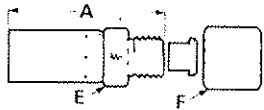

1/4	5/16	J06U 755	1/2-20	2.41	-	1	.243	11/16	5/8
3/8	3/8	J06U 756	9/16-18	2.43	-	1-1/16	.267	11/16	11/16
1/2	1/2	J08U 758	3/4-16	2.52	-	1-1/8	.360	3/4	7/8

Inverted male swivel straight

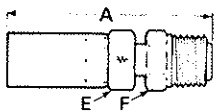

1/4	1/4	J04U 804	7/16-24	2.80	-	1-7/16	.152	9/16	7/16
3/8	3/8	J06U 806	5/8-18	3.11	-	1-3/4	.245	11/16	5/8
1/2	1/2	J08U 808	3/4-18	3.18	-	1-13/16	.334	13/16	3/4

Male straight thread, o-ring, rigid



3/8	1/2	J06U P08	3/4-16	2.46	-	1-1/16	.267	7/8	-
1/2	1/2	J08U P08	3/4-16	2.46	-	1-1/16	.360	7/8	-
1/2	5/8	J08U P10	7/8-14	2.55	-	1-1/8	.360	1	-

Male straight thread o-ring, swivel 90° elbow

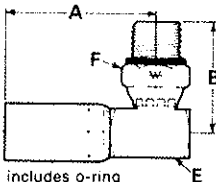

1/2	5/8	J08U R70	7/8-14	2.53	1.72	1-1/8	.360	3/4	1-1/8
-----	-----	----------	--------	------	------	-------	------	-----	-------

includes o-ring

COLLO-CRIMP® Hose End Fittings for Rubber Hose

Air brake swivel

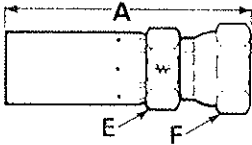

Hose I.D.	Pipe Size	Catalog Number	Thread Size	A	B	Hose Cut-Off Factor†	Hole Dia.	Hex E	Hex F
3/8	-	J06U-ABS	3/4-20	2.50	-	1-1/8	.267	11/16	7/8

POWER STEERING MAKE-UP INFORMATION

The Coll-O-Crimp System may be used to supplement the original equipment type power steering hose assembly inventory by using hose ends listed below and tubing (from the old hose assembly) to duplicate out of stock or slow moving hose assemblies.

3/8" SAE Swivel 5/8-18

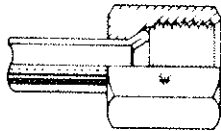

90° Elbow

J06U-464

TWO FIBER BRAID REINFORCEMENT

Cubical expansion: 9 to 15 ccw @ 1300 psi.
TEMPERATURE RANGE: -40° F. to +250° F.

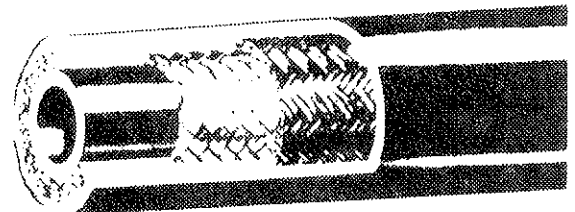

COLLO-CRIMP® Hose End Fittings for Rubber Hose

Female swivel 90° tube elbow

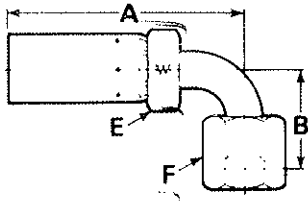

Hose I.D.	Pipe Size	Catalog Number	Thread Size	A	B	Hose Cut-Off Factor†	Hole Dia.	Hex E	Hex F
1/4	1/4	J04U-664	7/16-20	2.95	.68	1-9/16	.152	9/16	9/16
3/8	1/4	J06U-464	7/16-20	2.97	.68	1-9/16	.152	11/16	5/8
3/8	3/8	J06U-666	9/16-18	3.07	.85	1-11/16	.245	11/16	11/16
3/8	1/2	J06U-668	3/4-16	3.27	1.09	1-7/8	.267	3/4	7/8
1/2	1/2	J08U-668	3/4-16	3.25	1.09	1-7/8	.334	13/16	7/8

Female swivel

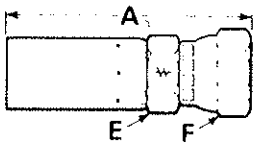

1/4	1/4	J04U-604	7/16-20	2.61	-	1-3/16	.161	1/2	9/16
1/4	5/16	J04U-605	1/2-20	2.67	-	1-1/4	.161	9/16	5/8
1/4	3/8	J04U-606	9/16-18	2.68	-	1-5/16	.161	9/16	11/16
3/8	1/4	J06U-404	7/16-20	2.66	-	1-1/4	.172	11/16	9/16
3/8	3/8	J06U-406	5/8-18	2.69	-	1-5/16	.267	11/16	3/4
3/8	3/8	J06U-606	9/16-18	2.71	-	1-5/16	.267	11/16	11/16
3/8	1/2	J06U-608	3/4-16	2.79	-	1-3/8	.267	3/4	7/8
3/8	5/8	J06U-610	7/8-14	3.00	-	1-5/8	.267	7/8	1

Male pipe swivel

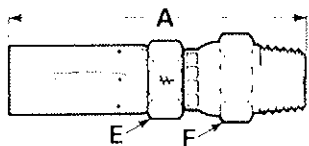

1/4	1/4	J04U-J04	1/4-18	3.38	-	2	.161	5/8	13/16
3/8	1/4	J06U-J04	1/4-18	3.40	-	1-15/16	.252	11/16	13/16
3/8	3/8	J06U-J06	3/8-18	3.35	-	2	.267	11/16	7/8

Male pipe—rigid

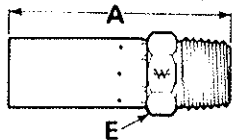

1/4	1/8	J04U-102	1/8-27	2.31	-	15/16	.161	1/2	-
1/4	1/4	J04U-104	1/4-18	2.49	-	1-1/8	.161	9/16	-
1/4	3/8	J04U-106	3/8-18	2.52	-	1-1/8	.161	11/16	-
3/8	1/4	J06U-104	1/4-18	2.52	-	1-1/8	.220	11/16	-
3/8	3/8	J06U-106	3/8-18	2.52	-	1-1/8	.267	11/16	-
3/8	1/2	J06U-108	1/2-14	2.77	-	1-3/8	.267	7/8	-
1/2	3/8	J08U-106	3/8-18	2.52	-	1-1/8	.360	3/4	-
1/2	1/2	J08U-108	1/2-14	2.77	-	1-3/8	.360	7/8	-
1/2	3/4	J08U-112	3/4-14	2.83	-	1-3/8	.360	1-1/16	-
5/8	1/2	J10U-108	1/2-14	3.31	-	1-7/16	.490	15/16	-
3/4	3/4	J12U-112	3/4-14	3.61	-	1-7/16	.611	1-1/16	-
3/4	1	J12U-116	1-11 1/2	3.84	-	1-5/8	.611	1-3/8	-
3/4	3/4	J16U-112	3/4-14	3.66	-	1-7/16	.662	1-3/8	-
1	1	J16U-116	1-11 1/2	3.84	-	1-5/8	.814	1-3/8	-

COLLO-CRIMP® Hose End Fittings for Rubber Hose

Female swivel

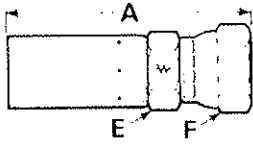

Hose I.D.	Pipe Size	Catalog Number	Thread Size	A	B	Hose Cut-Off Factor†	Hole Dia.	Hex E	Hex F
1/2	1/2	J08U-608	3/4-16	2.79	-	1-3/8	.360	3/4	7/8
1/2	5/8	J08U-610	7/8-14	3.00	-	1-5/8	.360	7/8	1
1/2	3/4	J08U-612	1-1/16-12	3.15	-	1-3/4	.360	1-1/16	1-1/4
3/4	3/4	J12U-412	1-1/16-14	3.86	-	1-11/16	.611	1-1/16	1-3/8
3/4	5/8	J12U-610	7/8-14	3.75	-	1-9/16	.480	1-1/16	1
3/4	3/4	J12U-612	1-1/16-12	3.86	-	1-11/16	.611	1-1/8	1-1/4
3/4	1	J12U-616	1-5/16-12	4.15	-	1-7/8	.611	1-1/4	1-1/2
1	7/8	J16U-614	1-3/16-12	3.96	-	1-3/4	.718	1-3/8	1-3/8
1	1	J16U-616	1-5/16-12	4.03	-	1-13/16	.814	1-3/8	1-1/2

Male pipe swivel

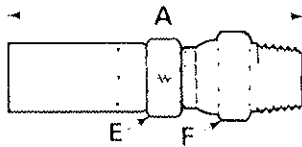

1/2	1/2	J08U-J08	1/2-14	3.62	-	2-1/4	.360	13/16	7/8
3/4	3/4	J12U-J12	3/4-14	4.73	-	2-9/16	.611	1-1/4	1-7/16

Inverted male swivel 90° tube elbow **

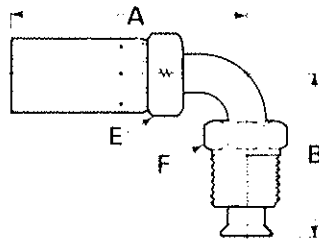

3/8	3/8	J06U-B66	5/8-18	3.68	1.97	2-5/16	.245	11/16	5/8
1/2	1/2	J08U-B68	3/4-18	3.63	2.32	2-1/4	.334	13/16	3/4

SAE 37° (JIC) male rigid

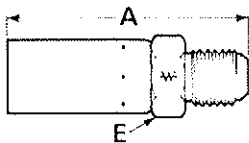

1/4	1/4	J04U-504	7/16-20	2.48	-	1-1/16	.161	1/2	-
1/4	5/16	J04U-505	1/2-20	2.48	-	1-1/16	.161	9/16	-
3/8	3/8	J06U-506	9/16-18	2.52	-	1-1/8	.267	11/16	-
3/8	1/2	J06U-508	3/4-16	2.68	-	1-1/4	.267	13/16	-
1/2	1/2	J08U-508	3/4-16	2.68	-	1-5/16	.360	13/16	-
1/2	5/8	J08U-510	7/8-14	2.81	-	1-7/16	.360	15/16	-
1/2	3/4	J08U-512	1-1/16-12	2.93	-	1-1/2	.360	1-1/8	-
3/4	3/4	J12U-512	1-1/16-12	3.72	-	1-1/2	.611	1-1/8	-



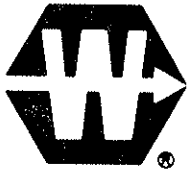



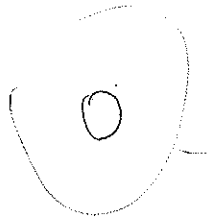

FASTENERS

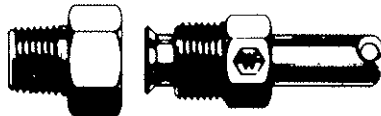

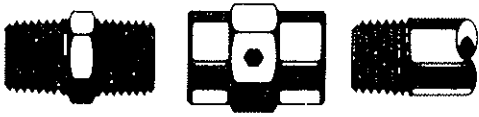
The Weatherhead Company

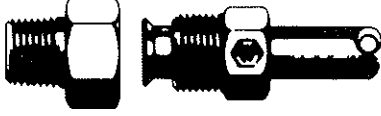
BRASS FITTINGS



INVERTED FLARE	
SAE 45° FLARE	
PIPE	
COMPRESSION	
HYDRAULIC BRAKE	
AIR BRAKE <ul style="list-style-type: none">•FOR NYLON TUBING•FOR COPPER TUBING•COMPONENTS	
DRAIN AND SHUT-OFF VALVES	
SPECIAL PURPOSE	

FASTENERS



INVERTED Brass Fittings FLARE

Typical applications:

Automotive brake, fuel, and oil lines. LP and natural gas connections.

Tube O.D.	1/8	3/16	1/4	5/16	3/8	7/16	1/2
Thread Size	5/16	3/8	7/16	1/2	5/8	1 1/16	3/4
Threads per Inch	28	24	24	20	18	18	18

USED WITH: Copper, brass, aluminum, and steel hydraulic tubing that can be flared.

PRESSURE: Depends on tubing used. Will stand burst pressure of standard tubing—up to 5000 psi with Bundyweld (double flared) and 3500 psi with copper tubing depending on size.

TEMPERATURE: —65F. to +250F. Has been used at +400F. at pressures under 1000 psi.

VIBRATION: Excellent resistance.

STANDARD NUT available in brass or steel	Tube O.D.	Catalog No.		Order No.	
		STEEL	BRASS	STEEL	BRASS
	3/16	105x3	100x3	J85010	J85001
	1/4	105x4	100x4	J85011	J85002
	5/16	105x5	100x5	J85012	J85003
	3/8	105x6	100x6	J85013	J85004
	1/2	105x8	100x8	J85015	J85006

PLUG (Steel)	Tube O.D.	Pipe Thd.	Catalog No.		Order No.	
			STEEL	BRASS	STEEL	BRASS
	3/16		131x3		J85025	
	1/4		131x4		J85026	
	5/16		131x5		J85027	
	3/8		131x6		J85028	

MALE CONNECTOR	Tube O.D.	Pipe Thd.	Catalog No.		Order No.	
			STEEL	BRASS	STEEL	BRASS
	3/16	1/8	202x3		J85030	
	1/4	1/8	202x4		J85032	
	1/4	1/4	202x4x4		J85034	
	5/16	1/8	202x5		J85036	
	5/16	1/4	202x5x4		J85038	
	3/8	1/4	202x6		J85040	
	3/8	1/8	202x6x2		J85042	
	3/8	3/8	202x6x6		J85044	
	1/2	3/8	202x8		J85048	
	1/2	1/4	202x8x4		J85050	
1/2	1/2	202x8x8		J85052		

FEMALE CONNECTOR	Tube O.D.	Pipe Thd.	Catalog No.		Order No.	
			STEEL	BRASS	STEEL	BRASS
	3/16	1/8	252x3		J85060	
	1/4	1/8	252x4		J85062	
	5/16	1/8	252x5		J85064	
	3/8	1/4	252x6		J85066	
	1/2	3/8	252x8		J85069	

UNION	Tube O.D.	Pipe Thd.	Catalog Number		Order Number	
			STEEL	BRASS	STEEL	BRASS
	3/16		302x3		J85075	
	1/4		302x4		J85077	
	5/16		302x5		J85079	
	3/8		302x6		J85081	
45° MALE ELBOW	3/16	1/8	352x3		J85090	
	1/4	1/8	352x4		J85091	
	5/16	1/8	352x5		J85092	
	5/16	1/4	352x5x4		J85093	
	3/8	1/4	352x6		J85094	
	3/8	1/8	352x6x2		J85095	
	1/2	3/8	352x8		J85097	
MALE ELBOW	3/16	1/8	402x3		J85101	
	1/4	1/8	402x4		J85103	
	1/4	1/4	402x4x4		J85106	
	5/16	1/8	402x5		J85107	
	5/16	1/4	402x5x4		J85110	
	5/16	3/8	402x5x6		J85111	
	3/8	1/4	402x6		J85113	
	3/8	1/8	402x6x2		J85115	
	3/8	3/8	402x6x6		J85117	
	1/2	3/8	402x8		J85121	
	1/2	1/4	402x8x4		J85123	
	1/2	1/2	402x8x8		J85125	
Restricted Male Elbow (.062" dia. hole through pipe end)						
	1/4	1/8	431x4		J85134	

ADAPTER TEE	Tube O.D.	Pipe Thd.	Catalog Number		Order Number	
			STEEL	BRASS	STEEL	BRASS
	3/16	1/8	552x3		J85154	
	1/4	1/8	552x3		J85155	
MALE BRANCH TEE	3/16	1/8	602x3		J85157	
	1/4	1/8	602x3		J85159	
MALE RUN TEE	3/16	1/8	752x3		J85186	
	1/4	1/8	752x4		J85188	

FASTENERS



Brass
Fittings

SAE 45° FLARE

Typical Applications:

Fuel, oil, air, water, LP and natural gas lines, refrigeration (except where frost nuts are required), hazardous liquids or gaseous chemicals not corrosive to tubing material or brass.

Tube O.D.	1/8	3/16	1/4	5/16	3/8	7/16	1/2
Thread Size	5/16	3/8	7/16	1/2	5/8	1 1/16	3/4
Threads per Inch	24	24	20	20	18	16	16

USED WITH: Copper, brass, aluminum, and steel hydraulic tubing that can be flared.

PRESSURE: Depends on tubing used. Will stand burst pressure of standard tubing—up to 5000 psi with Bundyweld (double flared) and 3500 psi with copper tubing depending on size.

TEMPERATURE: -65°F. to +250°F. Has been used at +400°F. at pressures under 1000 psi.

VIBRATION: Good—use long nut for excessive vibration.

	Tube O.D.	Pipe Thd.	Catalog Number	Order Number
MALE CONNECTOR 	3/16	1/8	48x3	J85256
	1/4	1/8	48x4	J85257
	1/4	1/4	48x4x4	J85258
	5/16	1/8	48x5	J85259
	5/16	1/4	48x5x4	J85260
	3/8	1/4	48x6	J85261
	3/8	1/8	48x6x2	J85262
	3/8	3/8	48x6x6	J85263
	3/8	1/2	48x6x8	J85264
	1/2	3/8	48x8	J85266
	1/2	1/4	48x8x4	J85267
	1/2	1/2	48x8x8	J85268

	Tube O.D.	Pipe Thd.	Catalog Number	Order Number
LONG NUT 	3/16		41x3	J85200
	1/4		41x4	J85201
	5/16		41x5	J85202
	3/8		41x6	J85203
	1/2		41x8	J85204

	Tube O.D.	Pipe Thd.	Catalog Number	Order Number
UNION 	3/16		42x3	J85215
	1/4		42x4	J85216
	5/16		42x5	J85217
	3/8		42x6	J85218
	1/2		42x8	J85219

	Tube O.D.	Pipe Thd.	Catalog Number	Order Number
MALE ELBOW 	3/16	1/8	49x3	J85274
	1/4	1/8	49x4	J85275
	1/4	1/4	49x4x4	J85276
	1/4	3/8	49x4x6	J85277
	5/16	1/8	49x5	J85278
	5/16	1/4	49x5x4	J85279
	3/8	1/4	49x6	J85280
	3/8	1/8	49x6x2	J85281
	3/8	3/8	49x6x6	J85282
	3/8	1/2	49x6x8	J85283
	1/2	3/8	49x8	J85285
	1/2	1/4	49x8x4	J85286
	1/2	1/2	49x8x8	J85287

* Shape slightly different than illustrated.

FASTENERS







BRASS PIPE FITTINGS



Typical Application:



Water, air, oil, natural gas and liquefied petroleum products.

Pipe Size	1/8	1/4	3/8	1/2	3/4
Thread Size	1/8-27	1/4-18	3/8-18	1/2-14	3/4-14

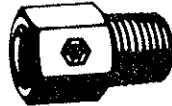
USED WITH: Brass or iron pipe.
PRESSURE: 1200 psi operating.
TEMPERATURE: -65 to +250F.
VIBRATION: Fair resistance.

	Pipe Thd.	Catalog Number	Order Number
CAP 	1/8	3129x2	J85400
	1/4	3129x4	J85401
SLOTTED PLUG 	1/8	3150x2	J85402
	1/4	3150x4	J85403
SQUARE HEAD PLUG 	1/8	3151x2	J85404
	1/4	3151x4	J85405
	3/8	3151x6	J85406
	1/2	3151x8	J85407
HEX HEAD PLUG 	1/8	3152x2	J85408
	1/4	3152x4	J85409
	3/8	3152x6	J85410
	1/2	3152x8	J85411
	3/4	3152x12	J85412



	Pipe Thd.		Catalog Number	Order Number
	FEM.	MALE		
ADAPTER 	1/8	1/8	3200x2	J85413
	1/4	1/4	3200x4	J85414
	1/4	1/8	3200x4x2	J85415
	3/8	3/8	3200x6	J85416
	3/8	1/4	3200x6x4	J85417
	1/2	3/8	3200x8x6	J85418
BUSHING 		MALE		
		FEM.		
	1/4	1/8	3220x4x2	J85419
	3/8	1/8	3220x6x2	J85420
	3/8	1/4	3220x6x4	J85421
	1/2	1/8	3220x8x2	J85422
	1/2	1/4	3220x8x4	J85423
	1/2	3/8	3220x8x6	J85424
	3/4	3/8	3220x12x6	J85425
3/4	1/2	3220x12x8	J85426	

	Pipe Thd.	Catalog Number	Order Number
UNION 	1/8	3250x2	J85427
	1/4	3250x4	J85428
COUPLING 	1/8	3300x2	J85429
	1/4	3300x4	J85430
	3/8	3300x6	J85431
	1/2	3300x8	J85432
REDUCING COUPLING 	1/4x1/8	3300x4x2	J85433
	3/8x1/8	3300x6x2	J85434
	3/8x1/4	3300x6x4	J85435
	1/2x3/8	3300x8x6	J85436

FASTENERS



BRASS PIPE FITTINGS — Cont.

	Pipe Thd.	Catalog Number	Order Number	
HEX NIPPLE 	1/8	3325x2	J85437	
	1/4	3325x4	J85438	
	3/8	3325x6	J85440	
	3/8x1/4	3325x8	J85443	
CLOSE NIPPLE 	1/8	3326x2	J85444	
	1/4	3326x4	J85445	
	3/8	3326x6	J85446	
	1/2	3326x8	J85447	
LONG NIPPLE 	1/8	1 1/2	3327x2	J85448
	1/4	1 1/2	3327x4	J85449
	1/8	2	3328x2	J85450
	1/4	2	3328x4	J85451
	3/8	2	3328x6	J85452
	1/8	2 1/2	3329x2	J85453
	1/4	2 1/2	3329x4	J85454
	3/8	2 1/2	3329x6	J85455
1/2	2 1/2	3329x8	J85456	

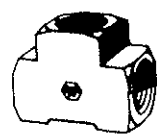
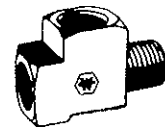
	Pipe Thd.	Catalog Number	Order Number
MALE BRANCH TEE for oil filter installations 	1/8	3600x2	J85473
	1/4	3600x4	J85474
	3/8	3600x6	J85475
TEE 	1/8	3700x2	J85476
	1/4	3700x4	J85477
	3/8	3700x6	J85478
	1/2	3700x8	J85479
STREET TEE for oil installations 	1/8	3750x2	J85480
	1/4	3750x4	J85481
	3/8	3750x6	J85482
	1/2	3750x8	J85483

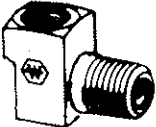
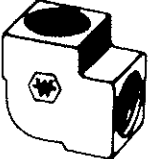
	Pipe Thd.	Catalog Number	Order Number
45° STREET ELBOW 	1/8	3350x2	J85460
	1/4	3350x4	J85461
	3/8	3350x6	J85462
	1/2	3350x8	J85463
STREET ELBOW 	1/8	3400x2	J85464
	1/4	3400x4	J85465
	3/8	3400x6	J85466
	1/2	3400x8	J85467
REDUCING ELBOW	1/4F. x 1/8M.	3400x4x2	J85468
ELBOW 	1/8	3500x2	J85469
	1/4	3500x4	J85470
	3/8	3500x6	J85471
	1/2	3500x8	J85472

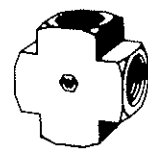
	Pipe Thd.	Catalog Number	Order Number
CROSS 	1/8	3950x2	J85484
	1/4	3950x4	J85485

FASTENERS



BRASS COMPRESSION FITTINGS

Typical Application:

Air, oil, water and lubrication lines.

Use long nut when excessive vibration may be encountered.



Tube O.D.	1/8	3/16	1/4	5/16	3/8
Thread Size	5/16	3/8	7/16	1/2	9/16
Threads per Inch	24	24	24	24	24



USED WITH: Copper, aluminum and plastic tubing. Not recommended for steel tubing. (Soft plastic tubing requires internal tube support.)



PRESSURE: Up to 2000 psi on 1/8" to 1/4" tubing. 1000 psi on 5/16" to 1/2" tubing and 750 psi on 5/8" to 1" sizes.

TEMPERATURE: -65F. to +250F.

VIBRATION: Fair resistance. Long nut improves vibration characteristics.

	Tube O.D.	Pipe Thd.	Catalog Number	Order Number
LONG NUT 	3/16		1611x3	J85319
	1/4		1611x4	J85320
	5/16		1611x5	J85321
	3/8		1611x6	J85322
UNION 	1/8		62x2	J85817
	3/16		62x3	J85328
	1/4		62x4	J85329
	5/16		62x5	J85330
	3/8		62x6	J85331

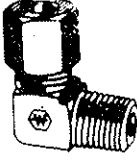
	Tube O.D.	Pipe Thd.	Catalog Number	Order Number
SLEEVE 	1/8		60x2	J85815
	3/16		60x3	J85301
	1/4		60x4	J85302
	5/16		60x5	J85303
	3/8		60x6	J85304
NUT 	1/8		61x2	J85816
	3/16		61x3	J85311
	1/4		61x4	J85312
	5/16		61x5	J85313
	3/8		61x6	J85314

	Tube O.D.	Pipe Thd.	Catalog Number	Order Number
MALE ELBOW 	1/8	1/8	69x2	J85819
	3/16	1/8	69x3	J85380
	1/4	1/8	69x4	J85381
	5/16	1/8	69x5	J85383
	3/8	1/4	69x6	J85385
MALE CONNECTOR 	1/8	1/8	68x2	J85818
	3/16	1/8	68x3	J85361
	1/4	1/8	68x4	J85362
	5/16	1/8	68x5	J85364
	3/8	1/4	68x6	J85366

FASTENERS

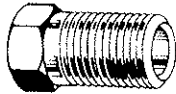

Brass Fittings HYDRAULIC BRAKE

LONG TUBE NUT	Tube O.D.	Cat. No.	Order Number
	3/16	7896x3	J85957
	1/4	7896x4	J85958

STEEL BRAKE LINES FOR IMPORTED CARS	BUBBLE FLARE SB and SC Series	
		

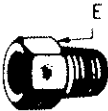
ADAPTER	Tube O.D.	Male Thread	Cat. No.	Order Number	
	3/16	7/16-24 (1/4" inv.)	7818	J85906	
	1/4	3/8-24* (3/16" inv.)	7828	J85907	
	1/4	1/2-20 (5/16" inv.)	7829	J85909	
	3/16	1/2-20* (5/16" inv.)	7897	J85910	
	1/4	9/16-18	7908	J85911	
	3/16	9/16-20	7910	J85913	
	3/16	9/16-18	7911	J85914	
	3/16	1/2-20	7912	J85915	
	(9/16-18)				
	3/16 (1/2-20)	9/16-18	7913	J85916	
	1/4				

* Sealing surface on hex face (E).

Length	British Cars 3/8-24 Thread	Order Number
8"	SB308	J85980
12"	SB312	J85981
20"	SB320	J85982
30"	SB330	J85983
40"	SB340	J85984
51"	SB351	J85985
60"	SB360	J85986
Length	European Cars 10-1.0 MM Thread	Order Number
8"	SC308	J85970
30"	SC330	J85973
51"	SC351	J85975
60"	SC360	J85976

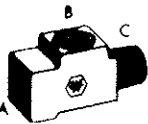
TOWED TRAILER BRAKE TEE	Tube A	Tube B	Male Thread C	Cat. No.	Order Number
	1/4	1/4	1/4 inv.	7898	J85960
	3/16	3/16	3/16 inv.	7900	J85961
	1/4	3/16	1/4 inv.	7901	J85962
	1/4	3/16	1/4 pipe	7902	J85963
	3/16 (9/16-18)	3/16	9/16-18 inv.	7903	J85964
	1/4 (9/16-18)	3/16	9/16-18 inv.	7904	J85965
	3/16 (9/16-20)	3/16	9/16-20 inv.	7905	J85966
	3/16 (1/2-20)	3/16	1/2-20 inv.	7906	J85967
For hydraulic brake installations on towed trailers.	3/16 (7/16-24)	3/16	1/4 inv.	7914	J85968

UNION TEE			
			
Inverted Seat	Hose End Port	Catalog Number	Order Number
3/16 (2)	7/16-20	7907	J85959

BRAKE LINE UNIONS

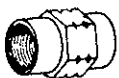

Catalog Number	Order Number	Description
1595	J85501	European line to European line (10 — 1.0 MM thread) (Bubble Flare) 'SC' Series

FASTENERS



Brass
Fittings

AIR BRAKE FOR NYLON TUBING

Application:





Air brake systems, air control and gauge lines.

Tube O.D.	1/4	3/8	1/2	5/8	3/4
Thread Size	1 1/16	1 1/32	1 1/16	1 3/16	1
Threads per inch	24	24	20	18	18

USED WITH: NT 100 Nylon Tubing.

PRESSURE: Exceeds pressure requirements of automotive air brake systems.

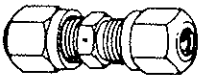
TEMPERATURE: -40F. to +200F.

	Tube O.D.	Pipe Thd.	Catalog Number	Order Number
SLEEVE 	1/4		1460x4	J85700
	3/8		1460x6	J85701
	1/2		1460x8	J85702
	5/8		1460x10	J85703
	3/4		1460x12	J85704
	NUT 	1/4		1461x4
3/8			1461x6	J85706
1/2			1461x8	J85707
5/8			1461x10	J85708
3/4			1461x12	J85709
UNION 	1/4		1462x4	J85710
	3/8		1462x6	J85711
	1/2		1462x8	J85712
	5/8		1462x10	J85713
	3/4		1462x12	J85714
	INSERT 	1/4		1484x4
3/8			1484x6	J85805
1/2			1484x8	J85806
5/8			1484x10	J85807
3/4			1484x12	J85808

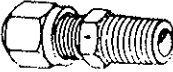
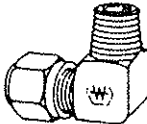
	Tube O.D.	Pipe Thd.	Catalog Number	Order Number
MALE CONNECTOR 	1/4	1/8	1468x4	J85731
	1/4	1/4	1468x4x4	J85732
	1/4	3/8	1468x4x6	J85733
	3/8	1/4	1468x6	J85736
	3/8	1/8	1468x6x2	J85737
	3/8	3/8	1468x6x6	J85738
	3/8	1/2	1468x6x8	J85739
	1/2	3/8	1468x8	J85740
	1/2	1/4	1468x8x4	J85741
	1/2	1/2	1468x8x8	J85742
	1/2	3/4	1468x8x12	J85743
	5/8	1/2	1468x10	J85744
	5/8	3/8	1468x10x6	J85745
	5/8	3/4	1468x10x12	J85746
	3/4	1/2	1468x12	J85747
	3/4	3/4	1468x12x12	J85748
90° MALE ELBOW 	1/4	1/8	1469x4	J85749
	1/4	1/4	1469x4x4	J85750
	1/4	3/8	1469x4x6	J85751
	3/8	1/4	1469x6	J85752
	3/8	1/8	1469x6x2	J85755
	3/8	3/8	1469x6x6	J85753
	3/8	1/2	1469x6x8	J85754
	1/2	3/8	1469x8	J85758
	1/2	1/4	1469x8x4	J85759
	1/2	1/2	1469x8x8	J85760
	5/8	1/2	1469x10	J85761
	5/8	3/8	1469x10x6	J85762
	5/8	3/4	1469x10x12	J85763
	3/4	1/2	1469x12	J85764
3/4	3/8	1469x12x6	J85765	

NYLON TUBING



SAE J844 Type A Single wall extruded Nylon (1/4" size)



SAE J844 Type B Extruded Nylon inner tube, one layer of open ply fiber reinforcement and a Nylon outer cover. (3/8", 1/2")

TEMPERATURE: -40°F to +200°F.
MAX. WORKING PRESSURE: 150 psi.
STANDARD PKG. (all sizes): 100'

Tube O.D.	Catalog Number	Order Number
1/4	NT10004	J85810
3/8	NT10006	J85811
1/2	NT10008	J85812

Tube O.D.	1/4	3/8	1/2
Thread Size	1 1/16	1 1/32	1 1/16
Threads per inch	24	24	24

FASTENERS



Brass
Fittings

AIR BRAKE FOR COPPER TUBING

Typical Application:
Air brake systems.

Tube O.D.	1/4	3/8	1/2	5/8	3/4
Thread Size	7/18	17/32	11/16	13/16	1
Threads per Inch	24	24	20	18	18

USED WITH: Copper tubing in air brake systems.

PRESSURE: Exceeds pressure requirements of automotive air brake systems.

TEMPERATURE: -65°F. to +250°F.

90° MALE ELBOW	Tube O.D.	Male Pipe	Catalog Number	Order Number
		1/4	1/8	W05539
	1/4	1/4	W24318	J85387
	3/8	1/8	W05522	J85388
	3/8	1/4	W05102	J85389
	3/8	3/8	W05829	J85390
	3/8	1/2	W22062	J85391
	1/2	1/4	W20475	J85392
	1/2	3/8	W15709	J85393
	1/2	1/2	W16310	J85394
	5/8	3/8	W21993	J85395
	5/8	1/2	W21825	J85396

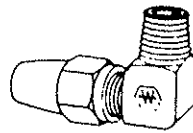

SLEEVE	Tube O.D.	Pipe Thd.	Catalog Number	Order Number
	1/4		W00457	J85305
	3/8		W00361	J85306
	1/2		W03764	J85307
	5/8		W10612	J85308
	3/4		W03897	J85309
NUT 	1/4		W00455	J85323
	3/8		W00360	J85324
	1/2		W03755	J85325
	5/8		W10613	J85326
	3/4		W03896	J85327
UNION 	1/4		W05514	J85332
	3/8		W05134	J85333
	1/2		W15710	J85334
	5/8		W21826	J85335
	3/4		W16523	J85336
MALE CONNECTOR 	1/4	1/8	W05127	J85367
	1/4	1/4	W05183	J85368
	3/8	1/8	W05509	J85369
	3/8	1/4	W05053	J85370
	3/8	3/8	W05824	J85371
	3/8	1/2	W22063	J85372
	1/2	1/4	W17690	J85373
	1/2	3/8	W17525	J85374
	1/2	1/2	W17691	J85375
	5/8	3/8	W16685	J85376
	5/8	1/2	W16684	J85377
	3/4	1/2	W17621	J85378
	3/4	3/4	W15762	J85379

BULKHEAD COUPLING (Steel)			
Pipe Thread		Catalog Number	Order Number
MALE	FEM.		
1/2	1/4	W05730	J85660

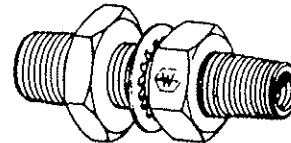

DRAINCOCK		
Male Pipe Thread	Catalog Number	Order Number
1/4	W15310	J85665

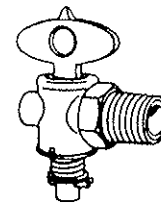



FASTENERS

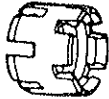

Brass
Fittings

AIR BRAKE COMPONENTS

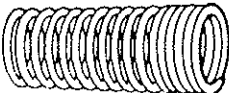
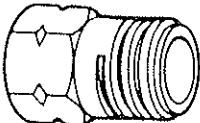
	Size	Catalog Number	Order Number
SLEEVE 	3/8	W03610	J85668
NUT 	3/8	W03624	J85670
SPRING GUARD 	3/8	W01045	J85672
NUT for SPRING GUARD 	3/8	W03613	J85674

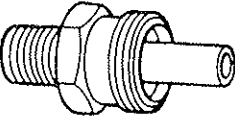
	Size	Pipe Thread	Catalog Number	Order Number
INSERT 	3/8	1/4-18	W15993	J85676
	3/8	3/8-18	W33470	J85677
	3/8	1/2-14	W15992	J85678



Brass
Fittings

DRAIN AND SHUT-OFF VALVES

USED WITH: Copper, aluminum, steel & plastic tubing where applicable.

PRESSURE: 150 psi maximum (Does not include plastic tubing).

TEMPERATURE: -65°F to 250°F.

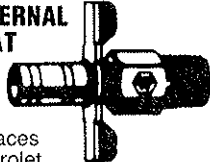
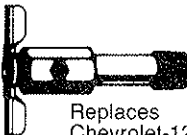
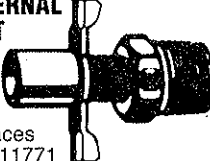
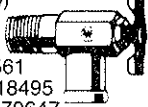
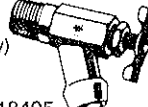
	Tube O.D.	Pipe Thd.	Catalog Number	Order Number
EXTERNAL SEAT 		1/8 1/4	135 145	J85525 J85526
INTERNAL SEAT  Replaces Chevrolet 3653586 and 3113456		1/8	6783	J85534
LONG  Replaces Chevrolet-120842	Length 1 3/4	1/8	185	J85533
EXTERNAL SEAT  Replaces GM-511771 Chrysler-836015		1/4	6788	J85535
For Water Heaters HOSE TO PIPE (Steel Body)  Replaces GM-3116561 Ford-7HA18495 Chrysler-670647	Hose Size 5/8	Pipe Thd. 3/8	211280	J85598
For Ford Hot Water Heaters HOSE TO PIPE (Steel Body)  Replaces Ford OA-18495	5/8	3/8	211273	J85599

FASTENERS



Brass
Fittings

SPECIAL PURPOSE

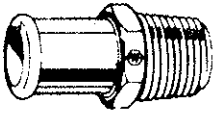
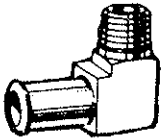
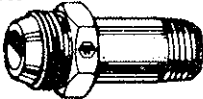
SPECIAL ADAPTERS	Size	Catalog Number	Order Number
WATER LINE CONNECTOR 	3/8 Pipe to 5/8 I.D. Hose	1411	J85601
	1/2 Pipe to 3/4 I.D. Hose	1430	J85602
	1/2 Pipe to 5/8 I.D. Hose	1431	J85603
WATER LINE ELBOW 	3/8 Pipe to 5/8 I.D. Hose	1599	J85604
TURBOCHARGER DISCHARGE CONNECTOR 	1" AC-811 Thread to 3/4 M.P.	1408	J85600

GLADHAND COUPLINGS

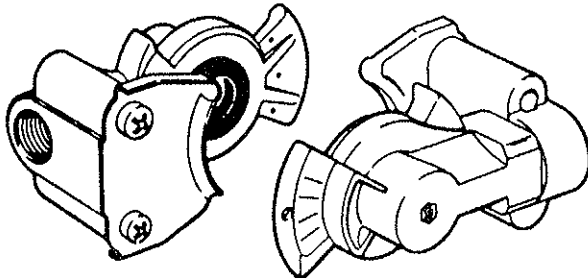

- DIE CAST ALUMINUM BODY
- CONFORMS TO SAE J318
- CONNECTS TO 1/2" PIPE

	Catalog Number	Order Number
SERVICE connect only to service	W78850	J85685
EMERGENCY connect only to emergency	W78851	J85686
UNIVERSAL connects to all three styles	W75150	J85687

GLADHAND SEAL



	Catalog Number	Order Number
GLADHAND SEAL	W13630	J85688

RIVET GUNS

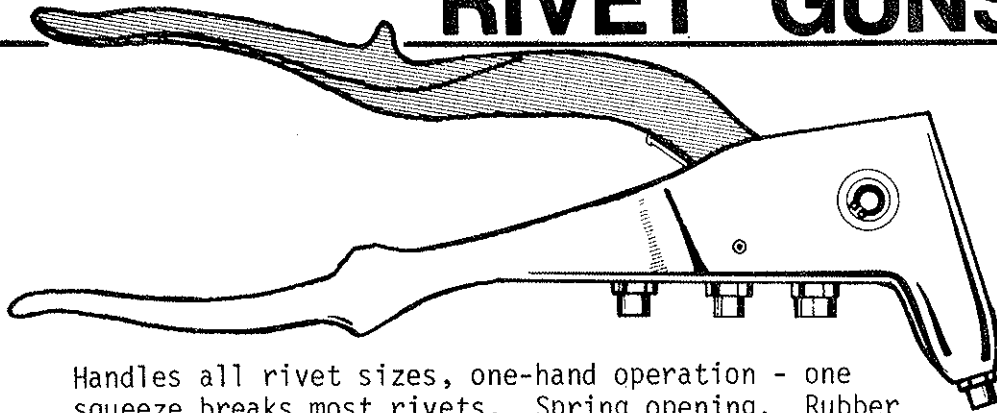

#J39000
RIVET GUN ONLY

Handles all rivet sizes, one-hand operation - one squeeze breaks most rivets. Spring opening. Rubber composition handle grips give firm no-slip grip. Interchangeable nosepieces screw into handle when not in use. Furnished with 4 standard nosepieces.

one per package

KLIK PLASTIC RIVET SETTER

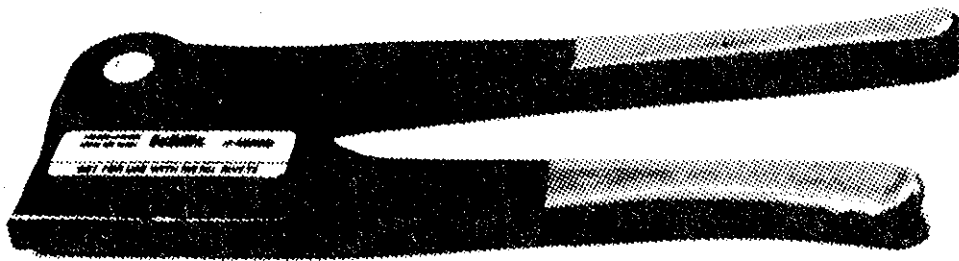

J48000

THE BIG ONE Hand Rivet Tool

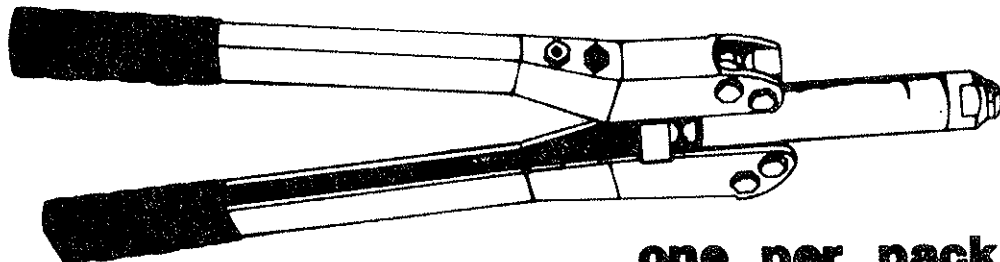

one per package

J39003

Hand rivet tool sets rivets from 1/8" through 1/4"! Aluminum, steel or stainless steel. Light weight, but tough and designed to set rivets in difficult places to reach. Special reduction gearing takes the hard work out of setting large size rivets. Useful for truck and trailer repairs, snowmobiles, and special automotive problem areas.

RIVETS

RIVET DIAMETER	RIVET SIZE HEAD STYLE	GRIP RANGE	PLATED STEEL RIVET STEEL MANDREL	ALUMINUM RIVET ALUMINUM MANDREL	ALUMINUM RIVET STEEL MANDREL	HEAD DIA.
1/8"	B4-2	.063 .125	J40112 SB4-2	J40212 AB4-2A	Pkg. 250 NOTE: #40215 USED FOR INSTALLATION OF PROTECTOR MOLDINGS.	1/4"
	B4-3	.126 .187	J40115 SB4-3	* J40214 ABL4-2A J40215 AB4-3A		.240
	C4-3	.126 .187	J40116 SC4-3	J40216 AC4-3A		1/4"
	B4-4	.188 .250	J40117 SB4-4	J40217 AB4-4A		.240
	C4-4	.188 .250	J40118 SC4-4	J40218 AC4-4A		1/4"
5/32"	D5-8	.376 .500		J40237 AB5-8A		5/16"
3/16"	B6-2	.020 .125		J40245 AB6-2A	J40347 AB6-4 J40349 AB6-6 J40350 ABL6-6	
	B6-4	.126 .250		J40247 AB6-4A		3/8"
	B6-6	.251 .375		J40249 AB6-6A		3/8"
	BL6-6	.251 .375		J40250 ABL6-6A		5/8"

* Item Pkg. 250

RIVET CODE EXPLANATION:

Example ABL6-6A
 A—First letter—rivet body material (A-aluminum S-steel C-copper SS-stainless)
 BL—Second and third letters—head style (B-buttonhead C-counter-sunk R-large BN-narrow)
 6—First number—Diameter in 32nds
 6—Second number—Maximum grip in 16ths
 A—Last letter—A-aluminum, SS-stainless, no letter—steel

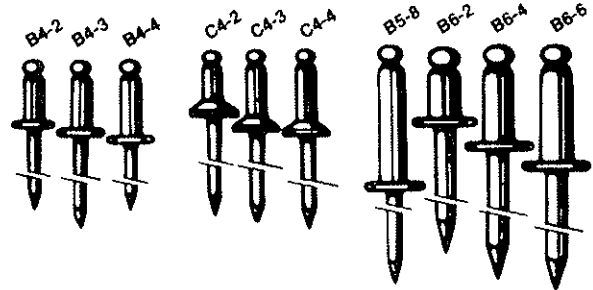

ALL ITEMS PACKAGED 50 PER PACK.

SPECIAL RIVETS 50 Per Pkg.

J42371 Window Regulator Rivets.

-GM cars, 1975-80 #9436175; Ford cars, 1976-80 #385189; Chrysler cars, 1977-80 #6031115.

J42372 Outside Door Handle Rivets.

-Ford, Mercury, Lincoln cars, 1978-80 #388047-S100.

J42376 Glass Stop Rivets.

-Ford cars, 1976-80 #385323, Chrysler cars, 1977-80 #6031091, GM cars 1979-80.

J43353 Trunk Lock Rivets.

-GM #9432137, Chrysler #6032138.

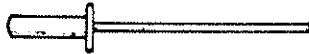

TRIM RIVETS 500 Per Pkg.

J40261 (ABN4-3A) Standard aluminum trim clip rivet. Use with 39112 nosepiece to form stud for trim clips.

J40262 (ABN4-4A) Long aluminum trim clip rivet. Same as 40261, but for use on filler covered panels.

J40516 (SSBN4-3) Standard stainless trim clip rivet. Stainless steel version of 40261 for high strength applications.

ALUMINUM RIVETS, PLATED STEEL MANDREL

J42377 A/S 44 Diameter: .125 Hole Size: .128-.132
 100 Per Pkg. Head Size: .250 Grip Range: .126-.250

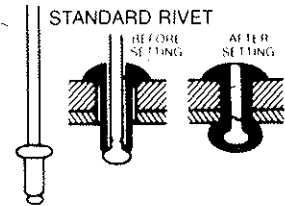

STANDARD RIVET



TRIM CLIP RIVET

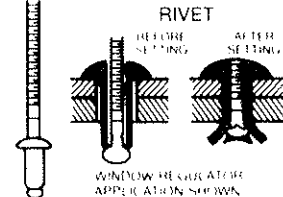

RIVET APPLICATION SHOWS

FASTENERS

SUPER TOUGH NYLON BLIND RIVETS*

For All Soft Material Blind "Pop Type" Rivet Applications

Super Tough Nylon Material, Non-Corrosive, Rust-Resistant, Non-Conductive. Will Not Mar Materials or Surfaces!

MANDREL BREAKS OFF CLEAN - NO TAB!

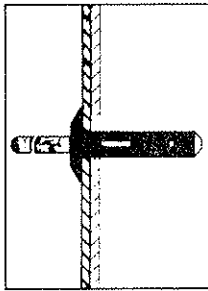

- Attractive Flanged Button Appearance when set.
- Large bearing surface prevents "Pull Out" and provides maximum Holding Power.
- Strong Clamping Action for soft Materials:
 RUBBER URETHANE
 FABRIC PLASTIC
 FIBERGLASS LAMINATES

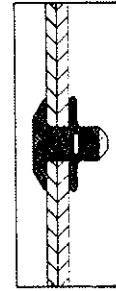

* available in individual package quantities or assortment

ORDER NUMBER	IND PKG QTY	(A) Hole Dia Range MM Inch**	(B) Panel Range MM Inch **	(C) Head Dia. MM Inch**	Color
J835642	25	5mm / 3/16	1.5 - 4.5 mm / 1/16 - 5/32	12mm / 1/2	Black
J835643	25	5 mm / 3/16	3 - 6 mm / 1/8 - 1/4	12mm / 1/2	Black
J835644	25	5 mm / 3/16	3 - 4.5 mm / 1/8 - 5/32	12 mm / 1/2	Black
J835645	25	5 mm / 3/16	6 - 10 mm / 1/4 - 3/8	12 mm / 1/2	Black
J835646	25	6.3 mm / 1/4	4 - 6mm / 5/32 - 1/4	17 mm / 11/16	White
J835647	25	6.3 mm / 1/4	4 - 10 mm / 5/32 - 3/8	17 mm / 11/16	Black
J835648	25	6.3 mm / 1/4	4 - 10 mm / 5/32 - 3/8	13 mm / 1/2	Black
J835649	25	6.3 mm / 1/4	2.5 - 5 mm / 3/32 - 3/16	13.08 mm / 1/2	Black
J835650	25	6.3 mm / 1/4	2.5 - 5 mm / 3/32 - 3/16	18 mm / 11/16	Black
J835664	25	6.3 mm / 1/4	4 - 10 mm / 5/32 - 3/8	17 mm / 11/16	Gray

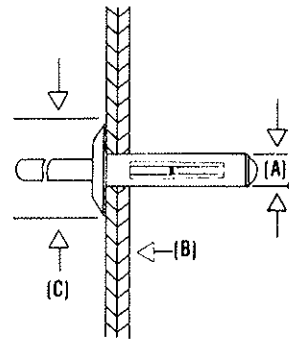

**Nominal Inch Measurement



**ASSORTMENT
J835727**
10 Items
165 Total Pieces

ASSORTMENT #J835727 —Contains—

- | | | |
|-----------------|-----------------|-----------------|
| 20 each J835642 | 15 each J835646 | 15 each J835650 |
| 20 each J835643 | 15 each J835647 | 10 each J835664 |
| 20 each J835644 | 15 each J835648 | |
| 20 each J835645 | 15 each J835649 | |

Cable Ties mean Confidence in Easy, Secure and Lasting Harness Tying

Permanent
Flexible
Security
Ease of application
Variety of sizes and types

J6270

Push Mount
White
8 7/16 Long
50/pk

Part #	Size	Color	Style
J6148	4	blk	standard
J6149	5 1/2	blk	standard
J6150	7 3/4	blk	standard
J6151	11 7/8	blk	standard
J6152	15 1/8	blk	standard
J6156	8 7/16	blk	mounting



STANDARD

DOUBLE LOOP

MOUNTING

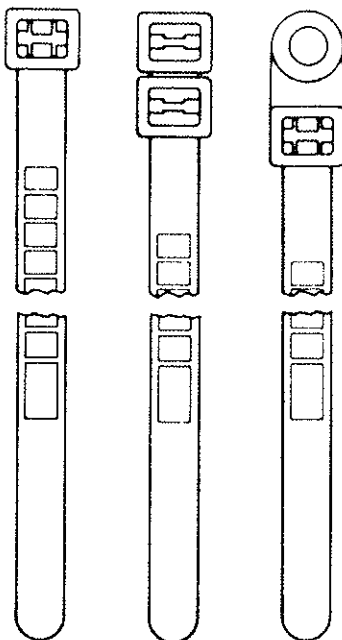

CABLE TIES	LENGTH/STYLE	PKG QTY	PART NO.	MIN. TENSILE STRENGTH	MILITARY STANDARD NO.	STUD SIZE
Miniature	3 3/4" 95,25mm	50	J6248	18 lbs.	3367-4	-
Intermediate	5 13/16" 147,64mm	50	J6249	30 lbs.	3367-5	-
Standard	7 15/16" 201,61mm	50	J6250	50 lbs.	3367-1	-
Standard	12 1/16" 306,39mm	50	J6251	50 lbs.	3367-7	-
Standard	15 1/16" 382,53mm	50	J6252	50 lbs.	3367-2	-
Standard Double Loop	15 7/32" 386,55mm	25	J6266	50 lbs.	No Applicable Standards	-
Mounting	8 7/16" 214,31mm	50	J6256	50 lbs.	No Applicable Standards	#10
Mounting	15 9/16" 395,29mm	25	J6258	50 lbs.	No Applicable Standards	#10
Heavy-Duty Mounting	15 21/32" 397,67mm	25	J6267	120 lbs.	No Applicable Standards	1/4"

ELECTRICAL TERMINALS

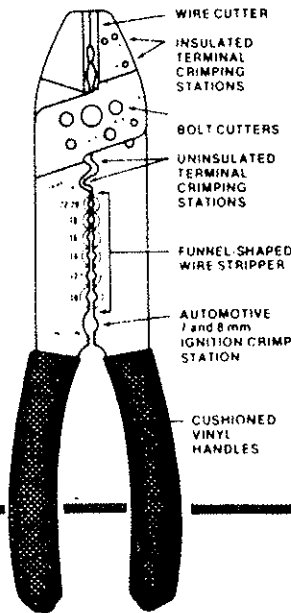

J88000

The J88000 is a crimping compact, high-quality tool designed to handle the six most common electrical wiring functions with ease and reliability.



WIRE
J88303 Blue 18-14

J88317 Red 18-22

J88318 Yellow 12-14

TAB 250



J88302

Terminal for one 16 gauge wire.



J88027

WIRE **TAB**
18-14 .250
USE WITH J88302

Scotchlok[®] BRAND

Instant Auto-Electric Connectors

- Full wire range – sizes to connect wires 22 thru 10 – AWG copper wire
- Makes all connections – tap, inline or pigtail and double run
- No special tools – use only a standard pair of pliers to make connection
- Easy, fast connections – no wire stripping, twisting or soldering

CHOOSE THE RIGHT CONNECTOR FOR THE RIGHT JOB! WIRE RANGES FROM 22 THROUGH 10.

J6127

General Purpose - Color Coded - Blue for general purpose electrical connections on auto, boat, van or trailer. Makes tap, inline or pigtail splices on solid or stranded wire. U.L. listed for 600 volts on tap connection only.
18-14 to 18-14 wire

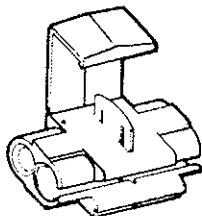

Pkg. 25

J6120

Improved Heavy Duty - Color Coded - Brown ideal for over-the-road equipment for tap, inline and pigtail splices. Includes port window for visual check on tape wire position, improved crimping ease, improved pull-out resistance. U.L. listed for 600 volts on tap splices.
18-12 to 12-10 wire

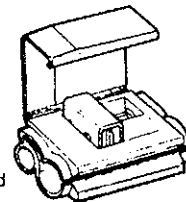

J6129

Low Voltage Accessories - Color Coded - Red use for low voltage accessories; such as radios, stereo speakers, tape decks and CB radios. Makes tap, inline and pigtail splices.
22-18 to 18-14 wire

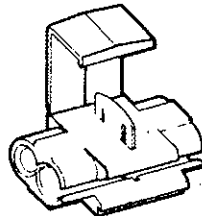

J6118 WHITE

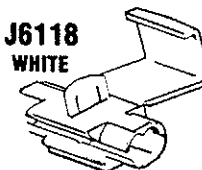

HERE'S HOW THEY WORK

Insert run tap wire into connector. Squeeze "U" contact down with pliers. Snap hinged cover.

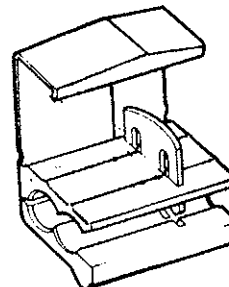

J6123

Extra Heavy Duty - Color Coded - Yellow use on fleet and off-the-road equipment for tap, inline and pigtail splicing heavy duty wire. U.L. listed for 600 volts on tap splices.
12-10 to 12-10 wire

ELECTRICAL TERMINALS

CRIMP N SEAL TERMINALS



COLOR CODED SOLID COPPER BUTT CONNECTOR WITH A CLEAR HEAT SHRINK TUBING CONTAINING A THERMOPLASTIC SEALER.

HEAT SHRINK TUBING PROVIDES EXCELLENT DIALECTRIC INSULATION AND ABRASION RESISTANCE.

THERMOPLASTIC SEALER PREVENTS MOISTURE, AIR OR CORROSION FROM DAMAGING CONNECTION.

NYLON INSULATED TERMINALS

INSTRUCTIONS

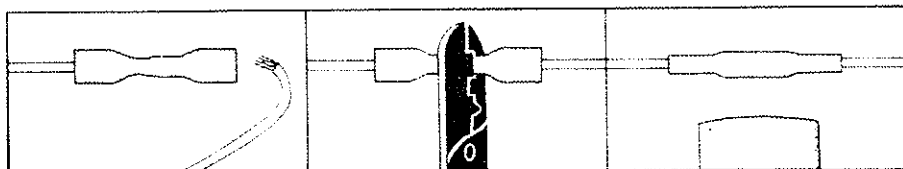

1. Insert stripped end of wire into butt splice.

2. Crimp splice in nest of tool designed for insulation connectors.

3. Apply heat source of approximately 275°F to 650°F. Move heat back and forth across tubing until shrinkage occurs.

J88972



J88974



J88976



J88973



J88975



J88977



GAUGE	COLOR	PKG.	PART No.	DESCRIPTION
22/18	RED	25	J88978	HEAT SEAL BUTT CONNECTOR
16/14	BLUE	25	J88979	HEAT SEAL BUTT CONNECTOR
12/10	YELLOW	25	J88980	HEAT SEAL BUTT CONNECTOR
22/18	RED	25	J88972	RING No. 10 STUD
16/14	BLUE	25	J88973	RING No. 1/4 STUD
12/10	YELLOW	25	J88974	RING No. 10 STUD
16/14	BLUE	25	J88975	SPADE No. 10 STUD
16/14	BLUE	25	J88976	FEM. QUICK SLIDE
16/14	BLUE	25	J88977	MALE QUICK SLIDE

ELECTRICAL TERMINALS

HEAT SHRINK TUBING

The heavy wall black irradiated polyolefin heat shrink tubing is lined with a white thermoplastic sealant which remains flexible for the life of the connection. The combination of heavy wall tubing and thermoplastic sealant provides:

- . Air and moisture proof insulation
- . Optimum protection against corrosion and abrasion
- . Additional strain relief and electrical insulation
- . Rated for continuous use at

(-85°F to 275°F)

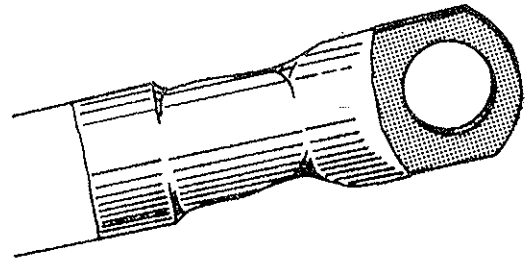
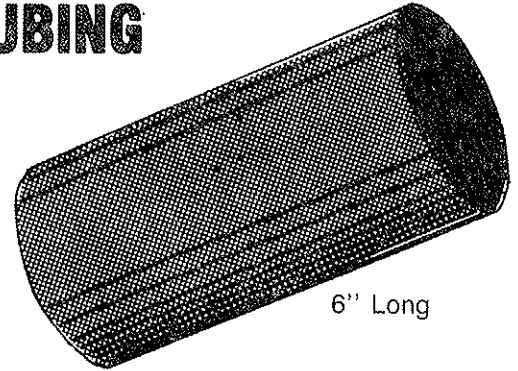

THICK WALL HEAT SHRINK TUBING 3 to 1 RATIO

PART NUMBER	WIRE RANGE	COLOR	PRE-SHRINK I.D.	POST SHRINK I.D.	PKG.
J88986	14-16	BLACK	.400	.150	5
J88988	8-1	BLACK	.750	.250	2
J88989	8-1	RED	.750	.250	2
J88990	2-40	BLACK	1.100	.375	2
J88991	2-40	RED	1.100	.375	2

THIN WALL HEAT SHRINK TUBING 2 to 1 RATIO

J88981	20-18	RED	.125	.062	10
J88982	16-14	BLUE	.250	.125	10
J88983	12-10	YELLOW	.310	.125	10
J88984	8-2	BLACK	.500	.250	10
J88985	1-30	BLACK	1.00	.500	10

ELECTRICAL TERMINALS

J88319

SELF STRIPPING FUSE HOLDER

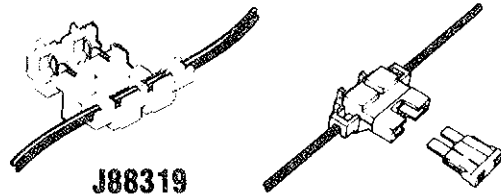

J88319

4 WIRE TRAILER CONNECTOR WITH 60" LOOP

J88501

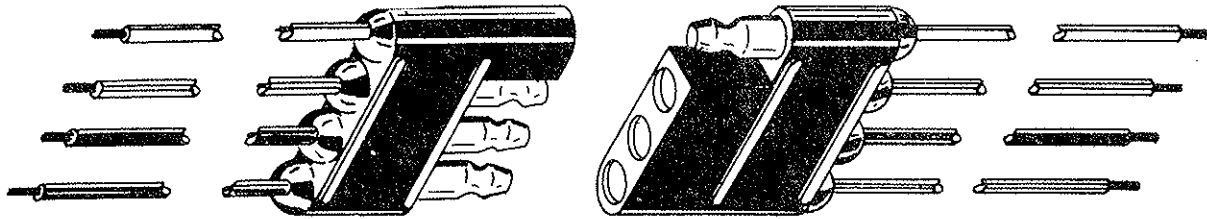

J88503

MOLDED WIRING HARNESS

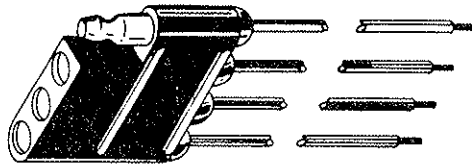

J88502 Three female-One male, 60" leads

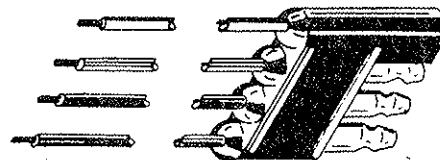

J88503 Three male-One female, 12" leads

WIRE NUT® CONNECTORS



J10379

BLUE

Joins No. 18 thru No. 14
AWG Wires
Minimum-2 No. 18
Maximum-3 No. 16



J10381

YELLOW

Joins No. 18 thru No. 12
AWG Wires
Minimum-1 No. 14 & 1
No. 18
Maximum-2 No. 14 & 3
No. 16

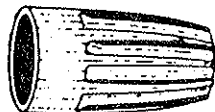

J10382

RED

Joins No. 18 thru No. 10
AWG Wires
Minimum-1 No. 12 & 2
No. 18
Maximum-2 No. 10 & 1
No. 12

All Packed 25

ELECTRICAL TERMINALS



J88300
WIRE
22-18



J88301
WIRE
22-18



J88027
WIRE 18-14 TAB
.250

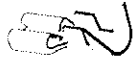

J88037
WIRE 18-14 TAB
.250



J88090
TAB
.250

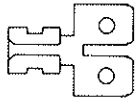

J88025
TAB
.250



J88018
WIRE 16-14 STUD
10



J88019
WIRE 12-10 STUD
10



T TAP CONNECTOR

J88081

WIRE
16-14



J88177
TAB
.250



J88095
WIRE 26-20 TAB
.110

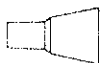

J88186
WIRE
22-14

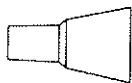

J88187
WIRE
18-10

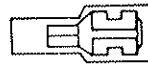

J88091
WIRE 22-18 TAB
.250

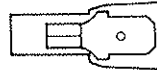

J88092
WIRE 22-18 TAB
.250

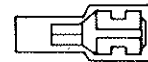

J88088
WIRE 16-14 TAB
.250

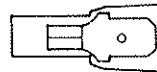

J88089
WIRE 16-14 TAB
.250

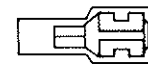

J88093
WIRE 12-10 TAB
.250



J88094
WIRE 12-10 TAB
.250



J88086
WIRE 22-18 SNAP
.176

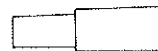

J88084
WIRE 22-18 SNAP
.157



J88087
WIRE 16-14 SNAP
.176



J88085
WIRE 16-14 SNAP
.157

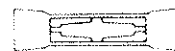

J88178
SNAP
.157

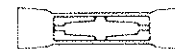

J88179
SNAP
.176



J88360
10 per pack



J88320
Replaces 12004542
Terminal. Radio Connectors
G.M. '78/
UNIT PACKAGE 100

ELECTRICAL TERMINALS



J88033
WIRE 16-14 TAB .250

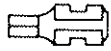

J88023
WIRE 16-14 TAB .187



J88026
WIRE 16-14 TAB .250

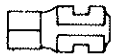

J88038
WIRE 12-10 TAB .250

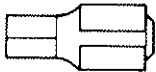

J88069
WIRE 12-10 TAB .375

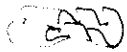

J88099
WIRE 18-14 TAB .250



J88036
WIRE 12-8 TAB .375

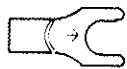

J88116
WIRE 12-10 STUD 10

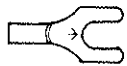

J88148
WIRE 16-14 STUD 4-6



J88124
WIRE 16-14 STUD 6



J88014
WIRE 16-14 STUD 6

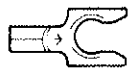

J88125
WIRE 16-14 STUD 10



J88015
WIRE 16-14 STUD 10

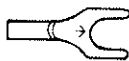

J88149
WIRE 16-14 STUD 10



J88184
WIRE 12-8 TAB .375



J88185
WIRE 16-14 TAB .250



J88021
WIRE 16-14 STUD 10



J88022
WIRE 12-10 STUD 10

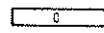

J88028
WIRE 22-18

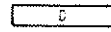

J88029
WIRE 16-14



J88030
WIRE 12-10

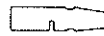

J88070
WIRE 22-18 SNAP .157

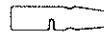

J88071
WIRE 22-18 SNAP .176

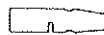

J88039
WIRE 16-14 SNAP .157



J88035
WIRE 18-14 TAB .250



J88024
TAB .250

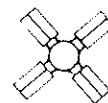

J88032
WIRE 16-14

ELECTRICAL TERMINALS

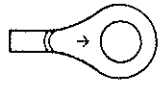

J88005
 WIRE 22-18 STUD 1/4



J88139
 WIRE 16-14 STUD 5-6



J88141
 WIRE 16-14 STUD 1/4

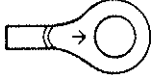

J88142
 WIRE 16-14 STUD 5/16

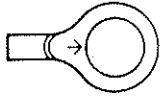

J88143
 WIRE 16-14 STUD 3/8

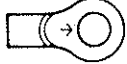

J88133
 WIRE 12-10 STUD 10

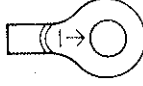

J88134
 WIRE 12-10 STUD 1/4

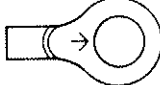

J88135
 WIRE 12-10 STUD 5/16

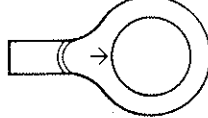

J88137
 WIRE 12-10 STUD 1/2

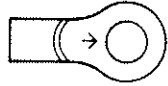

J88121
 WIRE 8AWG STUD 1/4

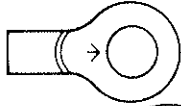

J88122
 WIRE 8AWG STUD 5/16

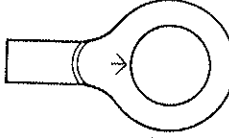

J88123
 WIRE 8AWG STUD 1/2

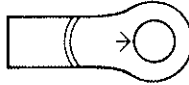

J88108
 WIRE 6AWG STUD 1/4

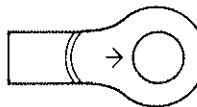

J88109
 WIRE 6AWG STUD 5/16

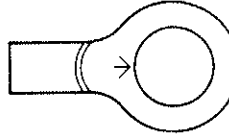

J88111
 WIRE 6AWG STUD 1/2

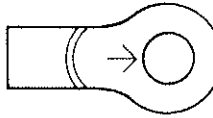

J88112
 WIRE 4AWG STUD 5/16

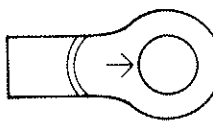

J88113
 WIRE 4AWG STUD 3/8

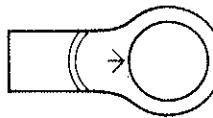

J88114
 WIRE 4AWG STUD 1/2

ELECTRICAL TERMINALS



J88041
WIRE 22-18 STUD 5-6



J88042
WIRE 22-18 STUD 10

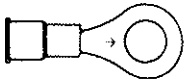

J88043
WIRE 22-18 STUD 1/4

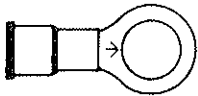

J88101
WIRE 22-18 STUD 3/8

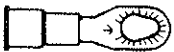

J88102
WIRE 22-18 STUD 2-6



J88103
WIRE 22-18 STUD 6-10

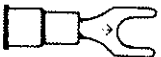

J88159
WIRE 22-18 STUD 10

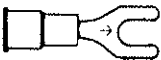

J88056
WIRE 22-18 STUD 6



J88104
WIRE 22-18 STUD 4



J88105
WIRE 22-18 STUD 6

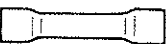

J88059
WIRE 22-18



J88207
WIRE 22-18 TAB .187



J88172
WIRE 22-18 TAB .187



J88062
WIRE 22-18 TAB .250



J88173
WIRE 22-18 TAB .250

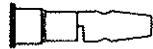

J88075
WIRE 22-18 SNAP .157

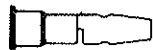

J88076
WIRE 22-18 SNAP .176

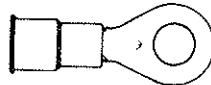

J88198
WIRE 8AWG STUD 1/4

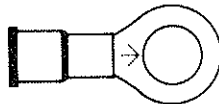



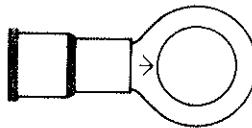









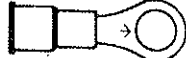

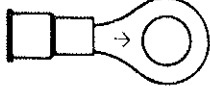

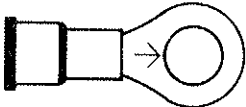
J88200
WIRE 8AWG STUD 3/8

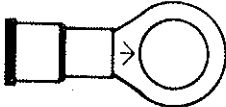

J88201
WIRE 8AWG STUD 1/2

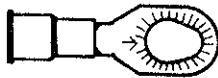
VINYL INSULATED ELECTRICAL TERMINALS

	<p>J88044</p> <p>WIRE 16-14 STUD 5-6</p>		<p>J88146</p> <p>WIRE 16-14 STUD 4-6</p>
	<p>J88045</p> <p>WIRE 16-14 STUD 8</p>		<p>J88147</p> <p>WIRE 16-14 STUD 10</p>
	<p>J88046</p> <p>WIRE 16-14 STUD 10</p>		<p>J88053</p> <p>WIRE 16-14 STUD 6</p>
	<p>J88047</p> <p>WIRE 16-14 STUD 1/4</p>		<p>J88191</p> <p>WIRE 16-14 STUD 10</p>
	<p>J88107</p> <p>WIRE 16-14 STUD 5/16</p>		<p>J88060</p> <p>WIRE 16-14</p>
	<p>J88048</p> <p>WIRE 16-14 STUD 3/8</p>		<p>J88097</p> <p>WIRE 16-14 TAB .110</p>
	<p>J88188</p> <p>WIRE 16-14 STUD 2-6</p>		<p>J88192</p> <p>WIRE 16-14 STUD 4-6</p>
	<p>J88189</p> <p>WIRE 16-14 STUD 6-10</p>		<p>J88057</p> <p>WIRE 16-14 STUD 10</p>

VINYL INSULATED ELECTRICAL TERMINALS



J88067

WIRE 16-14
STUD .157

J88065

WIRE 16-14
STUD .250



J88068

WIRE 16-14
STUD .176



J88175

WIRE 16-14
STUD .250



J88098

WIRE 16-14
STUD .250



J88202

WIRE 6AWG
STUD 10

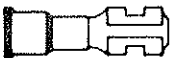

J88073

WIRE 16-14
STUD .187



J88203

WIRE 6AWG
STUD 1/4

J88174

WIRE 16-14
STUD .187

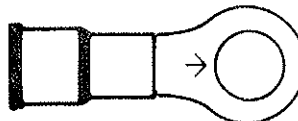

J88205

WIRE 6AWG
STUD 3/8

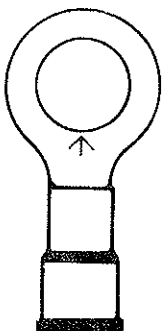

J88206

WIRE 6AWG
STUD 1/2

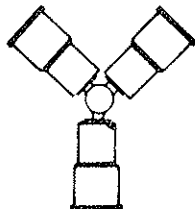

J88077

WIRE 16-14

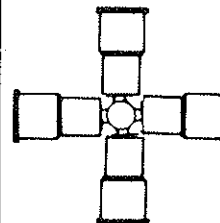

J88078

WIRE 16-14

VINYL INSULATED ELECTRICAL TERMINALS

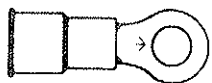

J88050

WIRE 12-10 STUD 10

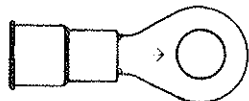

J88051

WIRE 12-10 STUD 1/4

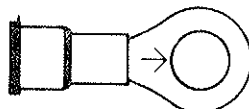

J88193

WIRE 12-10 STUD 5/16

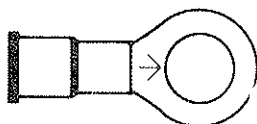

J88052

WIRE 12-10 STUD 3/8

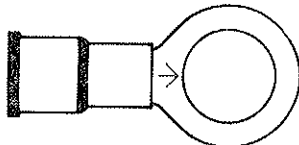

J88194

WIRE 12-10 STUD 1/2



J88195

WIRE 12-10 STUD 6-10



J88115

WIRE 12-10 STUD 10

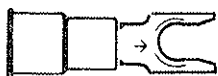

J88196

WIRE 12-10 STUD 8



J88120

WIRE 12-10 STUD 10

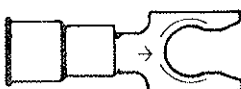

J88197

WIRE 12-10 STUD 1/4



J88058

WIRE 12-10 STUD 10



J88066

WIRE 12-10 TAB .250



J88176

WIRE 12-10 TAB .250



J88182

WIRE 12-10 TAB .250

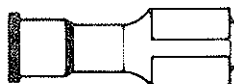

J88183

WIRE 12-10 TAB .375

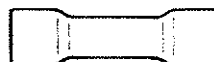

J88061

WIRE 12-10

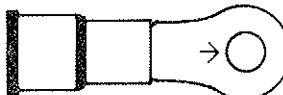

J88167

WIRE 4AWG STUD 8-10

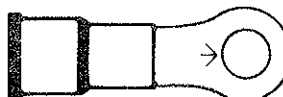

J88168

WIRE 4AWG STUD 1/4

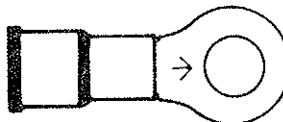

J88169

WIRE 4AWG STUD 5/16

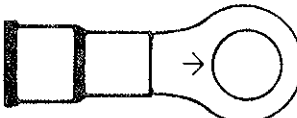

J88170



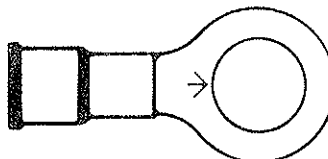







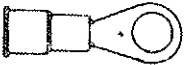

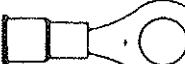



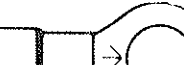
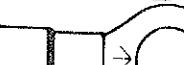







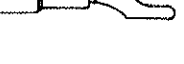

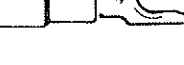

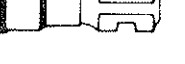
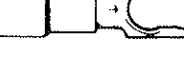



WIRE 4AWG STUD 3/8

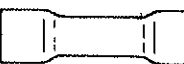

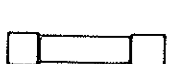
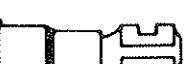
J88171

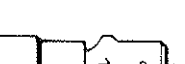
WIRE 4AWG STUD 1/2

NYLON INSULATED TERMINAL

	J88153 WIRE 22-18 STUD 10		J88128 WIRE 12-10 TAB 10		J88164 WIRE 16-14 STUD 1/4
	J88154 WIRE 22-18 STUD 1/4		J88129 WIRE 12-10 STUD 1/4		J88165 WIRE 16-14 STUD 5/16
	J88155 WIRE 22-18 STUD 5/16		J88131 WIRE 12-10 STUD 3/8		J88166 WIRE 16-14 STUD 3/8
	J88156 WIRE 22-18 STUD 4-6		J88132 WIRE 12-10 STUD 1/2		J88145 WIRE 16-14 STUD 10
	J88157 WIRE 22-18 STUD 10		J88138 WIRE 12-10 STUD 10		J88150 WIRE 16-14 STUD 6
	J88160 WIRE 22-18 STUD 4		J88117 WIRE 12-10 STUD 8 6		J88151 WIRE 16-14 STUD 10
	J88308 WIRE 22-18 TAB .187		J88118 WIRE 12-10 STUD 10		J88096 WIRE 16-14 STUD .110
	J88307 WIRE 22-18 TAB .187		J88119 WIRE 12-10 STUD 10		J88311 WIRE 16-14 TAB .187
	J88309 WIRE 22-18 TAB .250		J88080 WIRE 12-10		J88312 WIRE 16-14 TAB .187
	J88072 WIRE 22-18		J88316 WIRE 12-10 STUD .250		J88313 WIRE 16-14 TAB .250
	J88310 WIRE 22-18 TAB .250		J88315 WIRE 12-10 STUD .250		J88314 WIRE 16-14 TAB .250
	J88127 WIRE 12-10 TAB 5-6		J88162 WIRE 16-14 STUD 5-6		J88079 WIRE 16-14
			J88163 WIRE 16-14 STUD 10		

TERMINALS

GM ELECTRONIC CONTROL MODULE TERMINALS



J88334
(12034053, 12004610)

20-18 Ga

UNIT Package 25



J88335
(12020757)

20-18 Ga.

UNIT Package 25

FORD WEDGELOCK PIN TYPE TERMINALS



J88336
(D1AB-14461-AA)

Male Terminal
20-18 Ga

UNIT Package 25



J88337
(D1AB-14488-CA)

Female Terminal
20-18 Ga.

UNIT Package 25

FORD BOX FEMALE & TAB TERMINALS

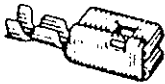

J88338
(D888-14474-BA, D3AB-14474-DA)

Female Terminal
20-18 Ga

UNIT Package 25



J88339
(D20B-14421-BB)

Male Terminal
20-18 Ga.

UNIT Package 25

FORD & CHRYSLER SNAP-ON FEMALE TERMINALS



J88340
(D5AB-14474-FA, D3AZ-14474-G)

20-18 Ga.

UNIT Package 25



J88341
(C5AB-14474-B; 2096466)

1/4" Female
20-18 Ga.

UNIT Package 25

CHRYSLER TERMINALS

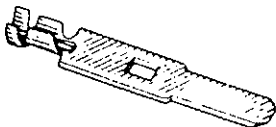

J88342
(3843386)

Male Tab
20-18 Ga.

UNIT Package 25



J88343
(3843601)

Center Tab Female
20-18 Ga.

UNIT Package 25

TERMINALS

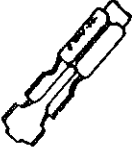
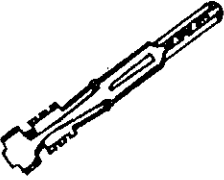
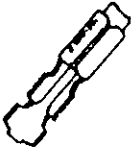
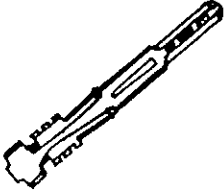
 <p>J86 6171 Replaces 12015857 Terminal (Metri-Pack) Female Use With 2.8mm Male Blade Terminal; Car-Pak 86-6172. 14-16 Gauge Wire G.M. <i>UNIT PACKAGE 25</i></p>	 <p>J86 6172 Replaces 12020116 Terminal. Male 2.8mm Blade Use With Female Terminal Car-Pak 86-6171. 14-16 Gauge Wire. <i>UNIT PACKAGE 25</i></p>
<p>J87 6173 Replaces 12034046 Terminal. Female Use With 2.8mm Male Blade Terminal Car-Pak 86-6174. 18-20 Gauge Wire. <i>UNIT PACKAGE 25</i></p> 	<p>J86 6174 Replaces 12034047 Terminal (Metri-Pack) Male 2.8mm Blade Use With Female Terminal Car-Pak 86-6173. 18-20 Gauge Wire <i>UNIT PACKAGE 25</i></p> 

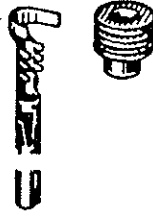
<h2>GM WEATHERPACK SERIES</h2>	
 <p>J88330 12014836 GM Products 18-20 Wire Gauge Tin Plated Brass - Silicone Male Terminal w/Cable Seals Unit Package 25 Sets</p>	 <p>J88331 12014837 GM Products 18-20 Wire Gauge Tin Plated Brass - Silicone Female Terminal w/Cable Seals Unit Package 25 Sets</p>
<h2>GM PACK CON SERIES</h2>	
 <p>J88332 (8900524) Male Tab Connector 18-14 Ga. Mates with 11947 <i>UNIT Package 25</i></p>	 <p>J88333 (12020346, 6294512) Female Receptacle 20-16 Ga. Mates with 11948 <i>UNIT Package 25</i></p>

SPECIALTY ITEMS

SECTION 2

	PAGE
ANCHOR NUT.....	60
BARREL NUTS.....	4
BATTERY BOLTS & NUTS.....	69
BODY BOLTS.....	72
BRASS MACHINE SCREWS.....	66
BUMPER BOLTS.....	69
CAP NUTS.....	2
CHRYSLER SPECIALTY HARDWARE.....	49-52
Bezel Nuts.....	51
Bumper Bolts.....	52
Clips.....	49,51
Door Panel Clips.....	49
Grommet Nuts.....	51
Headlamp Adjusting Assemblies.....	50
Headlamp Adjusting Nuts.....	50
Headlamp Adjusting Screws.....	50
Headlamp Adjusting Springs.....	50
Moulding Clips.....	49,51
Nuts.....	50,51
Panel Clips.....	49
Retainers.....	49
Rivets-Plastic.....	52
Rivets-Trim.....	52
Screws.....	50
Trim Clips.....	49
Trim Panel Rivets.....	52
Trim Retainers.....	49
Window Guide Kit.....	52
Windshield Moulding Screw.....	52
CLEVIS PINS.....	11,76
CONNECTORS.....	70,71
COUPLING NUTS.....	75
DRAIN PLUG GASKETS.....	2
DRAIN PLUGS.....	2
'E' RINGS.....	7
ELBOWS.....	71
EMISSION HOSE CONNECTORS.....	70
EXPANSION PLUGS.....	11
FENDER WASHERS.....	2
FINISHING WASHERS.....	12
FLOOR BOARD SCREWS.....	72

FORD SPECIALTY HARDWARE.....	38-48
Barrel Nuts.....	45
Body Bolts.....	44
Brake Adjusting Hole Cover.....	48
Bumper Bolt Nut.....	45
Clips.....	38-41,46,48
Door Panel Clip.....	38
Fender Bolts.....	44
Fusible Links.....	43
Headlamp Adjusting Assemblies.....	40,41
Headlamp Adjusting Clips.....	40,41
Headlamp Adjusting Nuts.....	40,41,45
Headlamp Adjusting Screws.....	40,41
License Nuts.....	45
Loom Clip.....	48
Moulding Clips.....	39
Nuts.....	40,41,45,46
Panel Clips.....	38
Pigtails.....	42,43
Pigtail Sockets.....	42,43
Retainers.....	38,46
Rivets, Aluminum.....	48
Rivets, Blind.....	47,48
Rivets, License.....	48
Rivets, Plastic.....	47,48
Screws.....	39-41
Sockets.....	42,43
Spare Tire Holddown.....	45
Trim Clips.....	38
Trim Retainers.....	38
Trim Screws.....	39
Tube Nut.....	46
U-Nuts.....	46
Vacuum Caps.....	41
Vacuum Tees.....	41
Window Guides.....	46
Window Roller & Nut.....	46
Wing Nuts.....	45
GENERAL PURPOSE SPECIALTY HARDWARE.....	61-64
Brass Machine Screws.....	66
Clips.....	62,64
Emission Hose Connectors.....	70
Extruded Nuts.....	63,64
Headlamp Adjusting Screws.....	61
Lock Nuts.....	1
Machine Screws, Brass.....	66
Marker Lamp Nuts.....	63
Moulding Clips.....	62
Pal Nuts.....	64
Panel Clips.....	62
Pigtails.....	64
Pigtail Sockets.....	64
Pushnut Retainers.....	64
Retainers.....	64

Self Tapping Screw.....	68
Sheet Metal Screws.....	66
Speed Clips.....	61,62
Speed Nuts.....	61,62
Tapping Screws.....	61,68
T-Bolts.....	62
Teks Screws.....	68
Thread Cutting Nuts.....	63
Thread Cutting Screws.....	68
Torx Screws.....	67
Trim Screws.....	63,65-67
Tube Nuts.....	61
U-Nuts.....	63-64
Vacuum Tees & Connectors.....	70,71
Washer Head Screws.....	65,68
Well Nuts.....	61
Wheel Opening Molding Screw.....	63
Wiper Hose Clamp.....	61
GM SPECIALTY HARDWARE	
Anchor Nuts.....	29,30
Barrel Nuts.....	29,30
Bumpers, Rubber.....	34
Bushings.....	37
Clips.....	14-18,23-25,33-36
Composite Headlamp Hardware.....	19
Door Lock Clips.....	18,36
Door Lock Knobs.....	18
Door Panel Clips.....	23,24,25,36
Fender Bolts.....	37
Gear Shift Knob.....	37
Guides-Window.....	28
Header Panel Nuts.....	29
Headlamp Adjusting Assemblies.....	19-21
Headlamp Adjusting Nuts.....	19-21,29,30
Headlamp Adjusting Screws.....	19,20,21,29,30
Headlamp Adjusting Springs.....	22
Headliner Clip.....	35
Jacknut.....	30
Lamp Screws.....	25
License Nuts.....	30
Lock Cylinder Caps.....	18
Lock Hardware.....	18
Mirror Bracket.....	36
Mirror Mounting Nut & Bolt.....	35,37
Moulding Clips.....	14-18,35
Nuts.....	19-21,29,30,33,35,36
Pigtails.....	31,32
Pigtail Socket Sets.....	31
Push Nuts.....	29,30,36
Radio Pigtails.....	31,32
Rivets-Aluminum.....	26-28
Rivets-Blind.....	26-28
Rivets-Plastic.....	26-28
Rivets-Steel.....	26-28
Rubber Bumpers.....	34

Screws.....	19-21,24,25,37
Shift Lever Knob.....	37
Shock Nuts.....	33
Sockets.....	31,32
Speed Clips.....	33
Speed Nuts.....	33
Trim Nuts.....	29,30
Trim Panel Clips.....	23-25
Trim Retainers.....	23,24,25,36
Trim Screws.....	24,25
Turn Signal Lever.....	36
U-Nuts.....	33
Wheel Opening Moulding Screws.....	25
Well Nut.....	35
Window Crank Handle Repair Kit.....	28
Window Guides.....	28
Window Regulator Tape.....	28
Windshield Washer Nozzle.....	36
Wing Nut.....	36
Wiring Clips.....	34
Wiring Retainers.....	34
GROMMETS.....	5
HAIRPIN RETAINERS.....	5,6
HEADLAMP ADJUSTING KIT.....	60
HEX WASHER HEAD TAPPING SCREWS.....	68
HOG RINGS.....	5
IMPORTS SPECIALTY HARDWARE.....	53-60
AUDI WINDSHIELD MOULDING CLIP.....	58
HONDA.....	53
License Nut.....	53
Moulding Clips.....	53
HYUNDAI.....	
Trim Clips.....	55
Trim Screws.....	55
Window Regulator Handles.....	55
MERCEDES PUSH NUT.....	58
MITSUBISHI MOULDING CLIP.....	59
NISSAN.....	54,55
Anchors, Anchor Nuts.....	54
Clips.....	54
Door Panel Clip.....	54
Grommet.....	54
Moulding Clips.....	55
Nuts.....	54
Retainer.....	54
Rivets.....	54
Trim Clips.....	54
Trim Screw.....	55
Well Nut.....	54
TOYOTA.....	56-58
Anchor Nuts.....	57
Clips-Exterior.....	57,58
Clips-Interior.....	57
License Nut.....	57
Moulding Clips.....	56,57,58
Panel Clips.....	57

VOLVO MOULDING CLIPS.....	59
VW.....	59
Moulding Clip.....	59
License Nut.....	59
KEPS NUTS.....	1
LICENSE BOLT & SLOTTED SCREW PKG.-PLATED.....	69
LICENSE BOLT W/NYLON HEX NUT.....	2
LICENSE PLATE SCREWS & NUTS.....	69,73,74
LINKAGE ROD CLIPS.....	3
LOCK NUTS.....	1
LOCKING/FINISHING WASHERS.....	12
MACHINE SCREWS, BRASS.....	66
METRIC LOCK NUTS.....	1
METRIC O-RINGS.....	12
NUT-HEADLAMP BEZEL.....	60
NUTS.....	1
Slotted Hex Nuts.....	1
Reversible Nuts.....	1
Lock Nuts.....	1
Keps Nuts.....	1
Nylon Lock Nuts.....	1
Serrated Flanged Nuts.....	1
Torque Lock Nuts.....	1
NYLON TUBING CLAMPS.....	72
OIL PAN DRAIN PLUGS.....	2
O-RING, AIR CONDITIONING.....	12
O-RING KITS.....	12
O-RINGS, METRIC.....	12
O-RINGS-RUBBER.....	12
O-RINGS, STANDARD.....	12
PAL NUTS.....	64
PHILLIPS WASHER HEAD TAPPING SCREWS.....	68
PIGTAIL SOCKETS.....	64
PUSH NUT RETAINERS.....	13
RESTRICTORS.....	71
RETAINERS.....	5-10
RETAINING RINGS/E-CLIPS/SNAP RINGS.....	7-10
REVERSIBLE NUTS.....	1
RIVETS-SCREW TYPE.....	60
RUBBER GROMMETS.....	5
SELF-TAPPING SCREWS.....	61,68
SERRATED FLANGED NUTS.....	1
SHEET METAL SCREWS.....	66
SLOTTED HEX NUTS.....	1
SNAP RINGS.....	8-10
SPEED NUTS.....	61,62
SPEED NUTS, BARREL TYPE.....	4
SPINLOCK BODY BOLTS.....	72
STEEL TUBING CLAMPS.....	72
TAPPING SCREWS.....	61,68
TEE CONNECTORS & CAPS.....	71
TEKS SCREWS.....	68
THREAD CUTTING SCREWS.....	68

THREADED ROD.....	75
TRIM SCREWS.....	63,65-67
TORQUE LOCK NUTS.....	1
TORX SCREWS.....	67
TRIM PANEL, ANCHOR NUT, BUMPER CLIP KIT.....	60
TUBING CLAMPS.....	72
VACUUM CAPS.....	71
VACUUM TEES & CONNECTORS.....	70,71
WASHERS.....	12
External Tooth Washers.....	12
Finishing Washers, Brass/Steel.....	12
Countersunk Washers.....	12
Internal Tooth Washers.....	12
Detent Washers.....	12
WASHER HEAD SCREWS.....	65,68
WINDSHIELD & MOULDING CLIP ASSORTMENT.....	60
WING NUTS.....	2
WOODRUFF KEYS.....	11
WYES.....	71
YOKE ENDS.....	76

SPECIAL FASTENERS

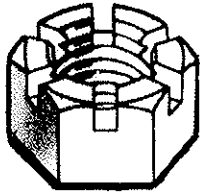

SLOTTED HEX NUTS

J31394	5/8-18	5/pk
J31395	3/4-16	2/pk

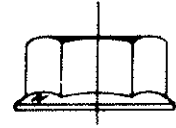
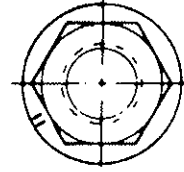

SERRATED FLANGED NUTS

J74498	10-24	25/pk
J75000	1/4-20	25/pk
J75001	5/16-18	25/pk
J75002	3/8-16	25/pk
J75003	7/16-14	25/pk

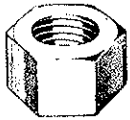

STEEL REVERSIBLE

J31337	1/4-20	25/pk
J31338	5/16-18	25/pk
J31339	3/8-16	25/pk
J31340	7/16-14	25/pk
J31341	1/2-13	25/pk



LOCK NUT ASSEMBLY (KEPS NUT)

J31301	6-32	25/pk
J31302	8-32	25/pk
J31303	10-24	25/pk
J31304	10-32	25/pk
J31307	1/4-20	25/pk
J31308	5/16-18	25/pk

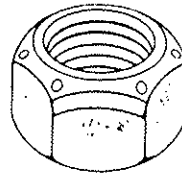

PREVAILING TORQUE LOCK NUTS

Grade C — Automation Style
Cadmium and Waxed
For Use with Grade 8 Bolts

J31360	1/4-20	25/pk
J31361	1/4-28	25/pk
J31362	5/16-18	25/pk
J31363	5/16-24	25/pk
J31364	3/8-16	25/pk
J31365	3/8-24	25/pk
J31366	7/16-14	25/pk
J31367	7/16-20	25/pk
J31368	1/2-13	25/pk
J31369	1/2-20	25/pk
J31370	9/16-12	25/pk
J31371	9/16-18	10/pk
J31372	5/8-11	10/pk
J31373	5/8-18	10/pk
J31374	3/4-10	10/pk
J31375	3/4-16	10/pk
J31376	7/8-9	5/pk
J31377	7/8-14	5/pk
J31378	1-8	5/pk
J31379	1-14	5/pk

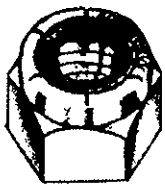

NYLON INSERT LOCK NUTS

USS THREAD

J31312	8-32	25/pk
J31313	10-24	25/pk
J31314	10-32	25/pk
J31317	1/4-20	25/pk
J31318	5/16-18	25/pk
J31319	3/8-16	10/pk
J31320	7/16-14	10/pk
J31321	1/2-13	10/pk
J31322	9/16-12	10/pk
J31323	5/8-11	10/pk

SAE THREAD

J31324	3/4-10	10/pk
J31325	7/8-9	10/pk
J31327	1/4-28	25/pk
J31328	5/16-24	25/pk
J31329	3/8-24	25/pk
J31330	7/16-20	25/pk
J31331	1/2-20	10/pk
J31332	9/16-18	10/pk
J31334	5/8-18	10/pk
J31335	3/4-16	10/pk
J31336	1-14	10/pk

METRIC

Thrd. pitch-coarse, DIN980V

J66500	*5mm x 0.8	25/pk
J66501	6mm x 1.0	25/pk
J66502	8mm x 1.25	25/pk
J66503	10mm x 1.5	25/pk

(*) Not heat treated. Not applicable for any heavy psi.

SPECIAL FASTENERS



FORGED WING NUTS

J47002 1/4-20 Forged 10 per pkg.
 J47003 5/16-18 Forged 10 "



CAP NUTS

J47004 1/4-20 Cap Nut 10 per pkg.
 J47005 5/16-18 Cap Nut 10 "



SLOTTED NYLON LICENSE BOLT WITH NYLON HEX NUTS

J9506 Pkg. 25
 1/4-20 X 9/16"



FENDER WASHERS

J37300 1/4 I.D.—1 1/2 O.D. 10/pk
 J37301 5/16 I.D.—1 1/2 O.D. 10/pk
 J37302 3/8 I.D.—1 1/2 O.D. 10/pk
 J37303 1/2 I.D.—2 O.D. 10/pk



CARBURETOR AIR CLEANER WING NUTS

J9507 25 Pkg.
 1/4-20 screw size
 (zinc plated)

STANDARD OIL PAN DRAIN PLUG



JOP5 1/2" dia. - 20 thread 10/pkg.

NYLON GASKETS FOR STANDARD PLUGS



fits
 JGN1 1/2 std. OP5 50/pkg.



STAMPED WING NUTS

J47000 1/4-20 Stamped 10 per pkg.
 J47001 5/16-18 Stamped 10 "

OVERSIZED SELF-TAPPING OIL PAN DRAIN PLUG

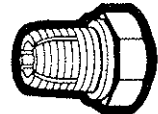

fits
 JOP10 1/2 OP5 10/pkg.
 *JOP10A 1/2 OP10 10/pkg.

*Used to replace stripped out OP10 self-tapping oversize plug.

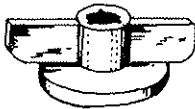

SELF THREADING NYLON WING NUTS

J76-4253 Pkg. 25
 1/4" or 6mm threads.

RUBBER DRAIN PLUG AND TOOL



Fits double oversize and triple oversize.

T280 1/2 1/pkg
 T281 5/8 1/pkg

LINKAGE ROD CLIPS



J9361 Pkg 25
for 1/8" rods
(#1L)



J9362 Pkg 25
for 5/32" rods
(#2L)



J9363 Pkg 25
for 3/16" rods
(#4L)



J9364 Pkg 25
for 1/4" rods
(#7L)



J9365 Pkg 25
for 1/8" rods
(#1R)



J9366 Pkg 25
for 5/32" rods
(#2R)



J9367 Pkg 25
for 3/16" rods
(#4R)



J9368 Pkg 25
for 1/4" rods
(#7R)

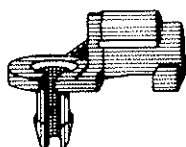

J9369 Pkg 25
Chry & Univ.
(2945108)
for 5/32" rods
NYLON R.H.



J9370 Pkg 25
Chry & Univ.
(2945109)
for 5/32" rods
NYLON L.H.

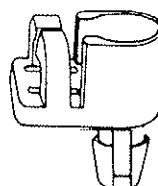

J9406 Pkg 25
CHRY & UNIVERSAL
(3796071)
Linkage rod clip
for 1/16" panel
thickness (nylon)

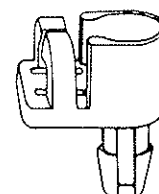

J9407 Pkg 25
CHRY & UNIVERSAL
(3796070)
Linkage rod clip
for 1/8" panel
thickness (nylon)



J9402 Pkg 25
FORD & UNIVERSAL
(C50B-62219A36A)
Remote control
rod clip with
nylon bushing
1/8" rod size



J9409 Pkg 25
FORD & UNIVERSAL
(D2VB-65219A35A)
Door lock rod
sleeve

BARREL TYPE SPEED NUTS



J9371 Pkg. 50
1/16" stud size
for 3/32" hole



J9372 Pkg. 50
1/32" stud size
for 1/8" hole



J9373 Pkg. 50
3/32" stud size
for 1/8" hole

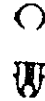

J9374 Pkg. 50
1/32" stud size
for 1/8" hole
(with sealer)



J9376 Pkg. 50
1/8" stud size
for 3/16" hole



J9377 Pkg. 50
1/8" stud size
for 3/16" hole
(with sealer)



J9378 Pkg. 50
1/8" stud size
for 11/64" hole



J9379 Pkg. 50
1/8" stud size
for 11/64" hole
(thick panels)



J9381 Pkg. 50
1/8" stud size
for 3/16" hole
(with sealer)



J9382 Pkg. 50
1/8" stud size
for 3/16" hole



J9383 Pkg. 50
5/32" stud size
for 7/32" hole



J9384 Pkg. 50
3/16" stud size
for 7/32" hole



J9385 Pkg. 50
3/16" stud size
for 7/32" hole
(thick panels)



J9386 Pkg. 50
3/16" stud size
for 15/64" hole



J9387 Pkg. 50
3/16" stud size
for 1/4" hole



J9388 Pkg. 50
3/16" stud size
for 5/16" hole



J9389 Pkg. 50
3/16" stud size
for 1/4" hole



J9390 Pkg. 50
3/16" stud size
for 1/4" hole
(with sealer)



J9392 Pkg. 50
1/4" stud size
for 5/16" hole



J9393 Pkg. 50
Rectangular stud
1/8"X3/8" size
5/32"X 7/16"hole

HAIRPIN RETAINERS



J9000 Pkg-50
for 3/64" groove
(.020 wire)



J9001 Pkg-50
for 1/16" groove
(.026 wire)



J9002 Pkg-50
for 1/8" groove
(.026 wire)



J9003 Pkg-50
for 3/16" groove
(.026 wire)



J9004 Pkg-50
for 3/16" groove
HEAVY DUTY
(.047)



J9005 Pkg-50
for 7/32" groove
(.032 wire)



J9006 Pkg-50
for 1/4" groove
HEAVY DUTY
(.062 wire)



J9015 Pkg-50
for 5/16" groove
HEAVY DUTY
(.062 wire)



J9007 Pkg-50
for 3/8" groove
HEAVY DUTY
(.062 wire)



J9008 Pkg-50
for 7/16" groove
HEAVY DUTY
(.105 wire)



J9009 Pkg-50
for 1/2" groove
HEAVY DUTY
(.106 wire)



J9010 Pkg-25
for 9/16" groove
HEAVY DUTY
(.106 wire)

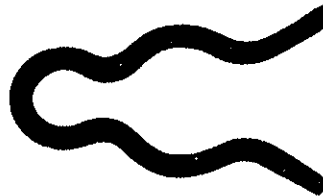

J9011 Pkg-25
for 5/8" groove
HEAVY DUTY
(.135 wire)

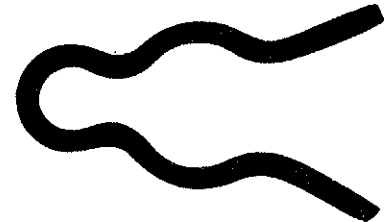

J9012 Pkg-25
for 11/16" groove
HEAVY DUTY
(.135 wire)

HOG RINGS



J46999 Pkg-100
Upholstery and
seat cover ring.

RUBBER GROMMETS (Pkg-25)

PART NO.	I.D.	HOLE SIZE
J9240	1/8"	1/4"
J9241	3/16"	5/16"
J9242	1/4"	3/8"
J8243	5/16"	7/16"
J9244	3/8"	1/2"
J9245	1/2"	5/8"
J9246	5/8"	7/8"



HAIRPIN RETAINERS



J9020 Pkg-50
1/8" shaft size
.035 wire diam.
(black finish)



J9021 Pkg-50
3/16" shaft size
.026 wire diam.
(black finish)



J9022 Pkg-50
3/16" shaft size
.040 wire diam.
(black finish)



J9023 Pkg-50
7/32" shaft size
.047 wire diam.
(black finish)



J9024 Pkg-50
1/4" shaft size
.032 wire diam.
(black finish)



J9025 Pkg-50
1/4" shaft size
.055 wire diam.
(black finish)



J9026 Pkg-50
5/16" shaft size
.040 wire diam.
(black finish)



J9027 Pkg-50
5/16" shaft size
.072 wire diam.
(black finish)



J9028 Pkg-50
3/8" shaft size
.062 wire diam.
(black finish)

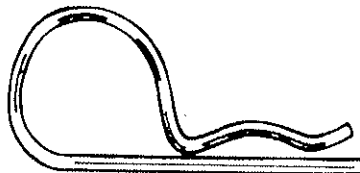

J9029 Pkg-25
5/16" shaft size
.090 wire diam.
(black finish)

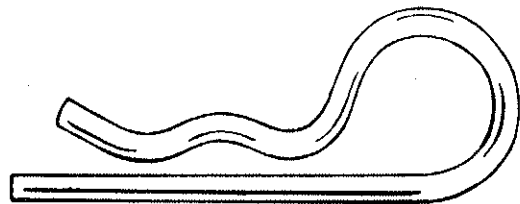

J9030 Pkg-10
1/2" shaft size
.155 wire diam.
(black finish)

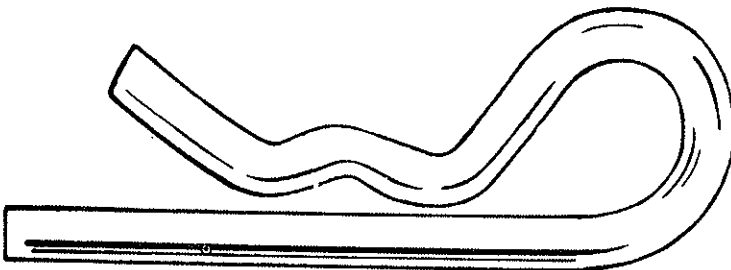

J9031 Pkg-10
9/16" shaft size
.310 wire diam.
(zinc plated)

Note: Shaft sizes shown are approximate, due to the flexibility of the hairpin itself. The most important factor is to determine which diameter wire will fit into the hole of the shaft or pin.

RETAINING RINGS

"E" STANDARD TYPE



J9100 Pkg-50
for 1/16" shaft



J9101 Pkg-50
for 3/32" shaft



J9102 Pkg-50
for 1/8" shaft



J9103 Pkg-50
for 9/64" shaft



J9104 Pkg-50
for 5/32" shaft



J9105 Pkg-50
for 3/16" shaft



J9106 Pkg-100
for 7/32" shaft



J9107 Pkg-100
for 1/4" shaft



J9108 Pkg-50
for 5/16" shaft



J9109 Pkg-50
for 3/8" shaft



J9110 Pkg-50
for 7/16" shaft



J9111 Pkg-50
for 1/2" shaft

"E" REINFORCED TYPE



J9150 Pkg-50
for 3/32" shaft



J9151 Pkg-50
for 1/8" shaft



J9152 Pkg-50
for 5/32" shaft



J9153 Pkg-50
for 3/16" shaft



J9154 Pkg-50
for 7/32" shaft



J9155 Pkg-50
for 1/4" shaft



J9156 Pkg-50
for 5/16" shaft



J9157 Pkg-50
for 3/8" shaft

RETAINING RINGS

"E" REINFORCED TYPE



J9158 Pkg-50
for 7/16" shaft



J9159 Pkg-50
for 1/2" shaft

EXTERNAL SNAP TYPE



J9170 Pkg-25
for 3/16" shaft



J9171 Pkg-25
for 1/4" shaft



J9172 Pkg-25
for 9/32" shaft



J9173 Pkg-25
for 5/16" shaft



J9174 Pkg-25
for 11/32" shaft



J9175 Pkg-25
for 3/8" shaft



J9176 Pkg-25
for 7/16" shaft



J9177 Pkg-25
for 1/2" shaft



J9178 Pkg-25
for 9/16" shaft



J9179 Pkg-25
for 5/8" shaft



J9180 Pkg-25
for 11/16" shaft



J9181 Pkg-25
for 3/4" shaft



J9182 Pkg-25
for 7/8" shaft



J9183 Pkg-25
for 1" shaft

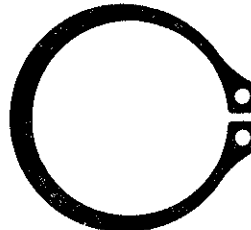

J9184 Pkg-25
for 1-1/16" shaft

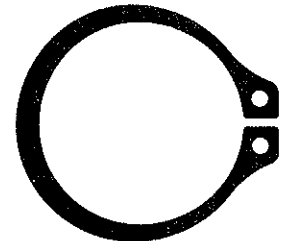

J9185 Pkg-25
for 1-1/8" shaft

RETAINING RINGS

EXTERNAL SNAP TYPE (CONT.)

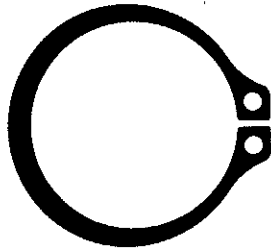

J9186 Pkg-25
for
1-3/16" shaft

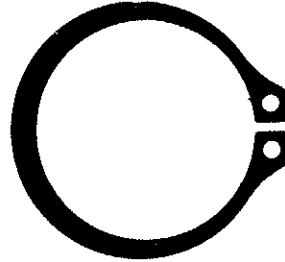

J9187 Pkg-25
for
1-1/4" shaft

INTERNAL SNAP TYPE



J9195 Pkg-25
for
1/4" housing



J9196 Pkg-25
for
5/16" housing



J9197 Pkg-25
for
3/8" housing



J9198 Pkg-25
for
7/16" housing



J9199 Pkg-25
for
1/2" housing



J9200 Pkg-25
for
9/16" housing



J9201 Pkg-25
for
5/8" housing



J9202 Pkg-25
for
11/16" housing

RETAINING RINGS



J9203 Pkg-25
for
3/4" housing



J9204 Pkg-25
for
13/16" housing

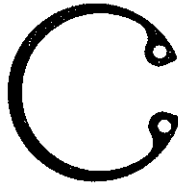

J9205 Pkg-25
for
7/8" housing

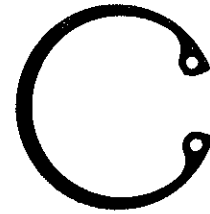

J9206 Pkg-25
for
1" housing

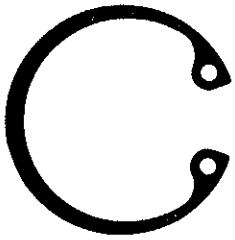

J9207 Pkg-25
for
1-1/16" housing

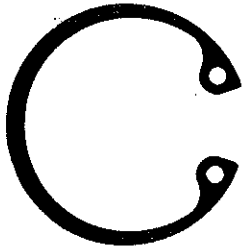

J9208 Pkg-25
for
1-1/8" housing

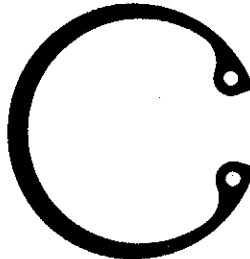

J9209 Pkg-25
for
1-3/16" housing

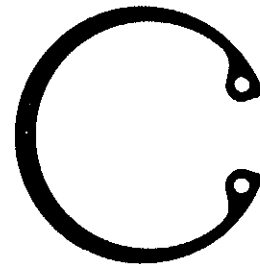

J9210 Pkg-25
for
1-1/4" housing

INTERNAL SNAP TYPE

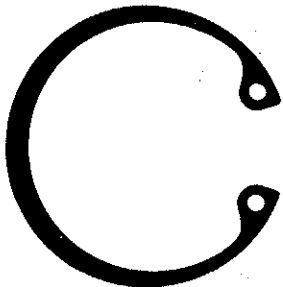

J9211 Pkg-25
for
1-5/16" housing

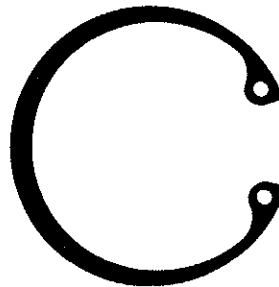

J9212 Pkg-25
for
1-3/8" housing

CLEVIS PINS-EXPANSION PLUGS-WOODRUFF KEYS

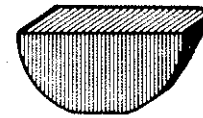

EXPANSION PLUGS
(zinc plated)
"FREEZE PLUGS"

WOODRUFF KEYS
(plain steel)

PART NO.	SIZE	TYPE	PACK. QUAN.
J9321	5/8"	concave	50
J9323	7/8"	"	50
J9325	1"	"	50
J9329	1-1/4"	"	50
J9335	1/2"	regular cup	25
J9336	19/32"	"	25
J9337	3/4"	"	25
J9338	7/8"	"	25
J9339	29/32"	"	25
J9340	1"	"	25
J9342	1- 7/32"	"	25
J9343	1-1/4"	"	25
J9345	1-1/2"	"	25
J9346	1-5/8"	"	25
J9347	1-3/4"	"	25
J9348	1-49/64"	"	25
J9349	1-15/16"	"	25
J9353	2-1/8"	"	25
J9354	2-1/4"	"	25

PART NO.	SIZE	PACK. QUAN.
J9076	3/32 X 1/2(#2)	50
J9077	3/32 X 5/8(#4)	50
J9079	1/8 X 5/8(#5)	50
J9080	1/8 X 3/4(#7)	50
J9081	5/32 X 5/8(#6)	50
J9082	5/32 X 3/4(#8)	50
J9087	3/16 X 1" (#13)	25
J9088	3/16 X 1-1/8(#16)	25
J9093	1/4 X 7/8 (#A)	25
J9094	1/4 X 1(#15)	25



UNIVERSAL CLEVIS PINS
(zinc plated)

PART NO.	SIZE	PACK. QUAN.
J9221	5/16" X 2"	25
J9222	3/8" X 2"	25
J9223	7/16" X 2"	25
J9224	7/16" X 2"	10
J9225	7/16" X 2-1/2"	10
J9226	1/2" X 2"	25
J9227	1/2" X 2-1/2"	10
J9228	1/2" X 3"	10
J9229	5/8" X 3"	10
J9230	3/4" X 3"	10

RUBBER O-RINGS

Metric O-Ring Kit PART NO. J81350

PART NO.	SERIES NOS.	WIDTH	INSIDE DIAMETER
J81361	004	2mm	4mm
J81362	005	2mm	5mm
* J81363	006	2mm	6mm
* J81364	007	2mm	7mm
* J81365	008	2mm	8mm
* J81366	010	2mm	10mm
* J81367	110	2.5mm	10mm
* J81368	111	2.5mm	11mm
* J81369	112	2.5mm	12mm
* J81370	114	2.5mm	14mm
* J81371	116	2.5mm	16mm
J81372	117	2.5mm	17mm
J81373	119	2.5mm	19mm
J81374	319	3mm	19mm
J81375	320	3mm	20mm
J81376	322	3mm	22mm
J81377	324	3mm	24mm
J81378	325	3mm	25mm
J81379	327	3mm	27mm
J81380	328	3mm	28mm
J81381	330	3mm	30mm
J81382	332	3mm	32mm
J81383	333	3mm	33mm
J81384	335	3mm	35mm
J81385	336	3mm	36mm
J81386	338	3mm	38mm
J81387	138	4mm	38mm
J81388	141	4mm	41mm
J81389	144	4mm	44mm

25 per PKG
if ordered
individually

* not available seperately

Each Metric Kit contains 392 O-rings in 30 popular German, British and Swedish metric sizes. All components are easily replaceable and refills are in stock. An approved mailing carton is also included for each kit.

Metric Splicing Kit • One three foot length of cord in each of nine metric cross sections: 1.5mm, 2.0mm, 2.5mm, 3.0mm, 3.5mm, 4.0mm, 5.0mm, 5.7mm, and 8.4mm.

J81351

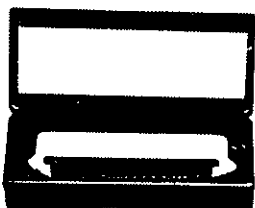

- All cord in 70 Durometer Buna-N manufactured within the same tolerances as molded O-rings.
- Step by step instructions.
- Razor blade, cutting and splicing jig, and one tube of quick drying cement.
- Replacement cord readily available.
- Sturdy case comes with approved mailing carton.

Standard O-Ring Kit PART NO. J81300

PART NO.	SERIES NOS.	NOMINAL SIZES		
		I.D.	O.D.	W.
J81310	006	1/8	1/4	1/16
J81311	007	5/32	9/32	1/16
J81312	008	3/16	5/16	1/16
J81313	009	7/32	11/32	1/16
J81314	010	1/4	3/8	1/16
J81315	011	5/16	7/16	1/16
J81316	012	3/8	1/2	1/16
J81317	110	3/8	9/16	3/32
J81318	111	7/16	5/8	3/32
J81319	112	1/2	11/16	3/32
J81320	113	9/16	3/4	3/32
J81321	114	5/8	13/16	3/32
J81322	115	11/16	7/8	3/32
J81323	116	3/4	15/16	3/32
J81324	210	3/4	1	1/8
J81325	211	13/16	1-1/16	1/8
J81326	212	7/8	1-1/8	1/8
J81327	213	15/16	1-3/16	1/8
J81328	214	1	1-1/4	1/8
J81329	215	1-1/16	1-5/16	1/8
J81330	216	1-1/8	1-3/8	1/8
J81331	217	1-3/16	1-7/16	1/8
J81332	218	1-1/4	1-1/2	1/8
J81333	219	1-5/16	1-9/16	1/8
J81334	220	1-3/8	1-5/8	1/8
J81335	221	1-7/16	1-11/16	1/8
J81336	222	1-1/2	1-3/4	1/8
J81337	325	1-1/2	1-7/8	3/16
J81338	326	1-5/8	2	3/16
J81339	327	1-3/4	2-1/8	3/16

Each Standard Kit contains 380 O-rings in the 30 most popular sizes. All components are easily replaceable and refills are in stock. An approved mailing carton is also included for each kit.

A-C O-RINGS

10 Pieces per pack

- J81400 BLEED, EQUALIZER, CAPILLARY TUBE
- J81401 #6 HOSE FITTING
- J81402 #8 HOSE FITTING
- J81403 #10 HOSE FITTING
- J81404 #12 HOSE FITTING
- J81405 #6 GM/COMB. VALVE EVAP PORT
- J81406 #8 GM O-RING
- J81407 #12 GM O-RING
- J81408 SUCTION FITTING
- J81409 SUCTION/DISCHARGE PORT

LOCKING TYPE AND FINISHING WASHERS

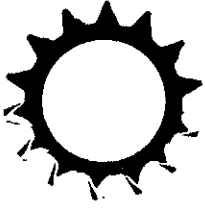

FLAT EXTERNAL TOOTH
(zinc plated)

PART NO.	SIZE	PACK. QUAN.
J9050	#6	50
J9051	#8	50
J9052	#10	50
J9053	#12	50
J9054	1/4"	50
J9055	5/16"	50
J9056	3/8"	50
J9057	7/16"	50
J9058	1/2"	50
J9059	9/16"	25



BRASS
COUNTERSUNK
FINISHING WASHERS
(nickel plated)

PART NO.	SIZE	PACK. QUAN.
J9271	#4	50
J9272	#6	50
J9273	#8	50
J9274	#10	50
J9275	#12	50



STEEL
COUNTERSUNK
FINISHING WASHERS
(nickel plated)

PART NO.	SIZE	PACK. QUAN.
J9281	#6	50
J9282	#8	50
J9283	#10	50



BRASS
FLUSH STYLE
FINISHING WASHERS
(nickel plated)

PART NO.	SIZE	PACK. QUAN.
J9292	#6	50
J9293	#8	50
J9294	#10	50
J9295	#12	50



COUNTERSUNK TOOTH
(zinc plated)

PART NO.	SIZE	PACK. QUAN.
J9066	#8	50
J9067	#10	50
J9068	#12	50
J9069	1/4"	50
J9070	5/16"	50
J9071	3/8"	50
J9072	7/16"	50



FLAT INTERNAL TOOTH
(zinc plated)

PART NO.	SIZE	PACK. QUAN.
J9035	#6	50
J9036	#8	50
J9037	#10	50
J9038	#12	50
J9039	1/4"	50
J9040	5/16"	50
J9041	3/8"	50
J9042	7/16"	50

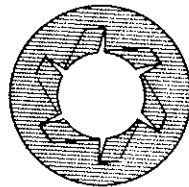

PUSH NUT BOLT RETAINERS
(will grip on bolt threads)

PART NO.	BOLT SIZE	O.D.	PACK. QUAN.
J9265	1/4"	1/2"	50
J9266	5/16"	5/8"	50
J9267	3/8"	25/32"	50
J9268	7/16"	27/32"	50
J9269	1/2"	15/16"	50



DETENT WASHERS (ROUND SPEED NUTS)
(used primarily for studs or rods)
Package-50

J9250	1/16" stud	J9257	1/4" stud
J9251	3/32" stud	J9258	5/16" stud
J9252	1/8" stud	J9259	3/8" stud
J9253	5/32" stud	J9261	1/2" stud
J9254	3/16" stud		

GM MOULDING CLIP

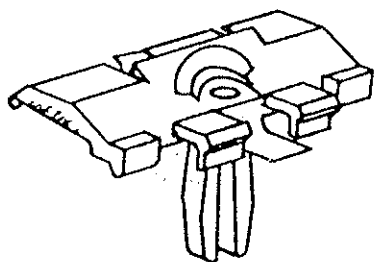

J86 6168

Replaces 20420558
 Clip Rear Belt Reveal Moulding,
 Plastic.
 Cadillac "C" Body (Fwd) '85/
 UNIT PACKAGE 25

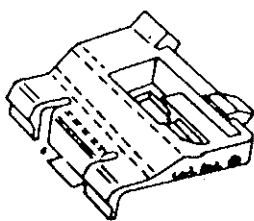

J87 6189

Replaces 20470354
 Clip Belt Reveal Moulding Rear
 Plastic.
 Cadillac "C" Body (Fwd) '85/
 UNIT PACKAGE 25

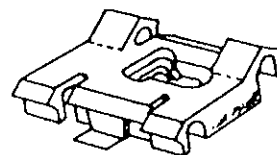

J87 6186

Replaces 20619098
 Clip, Reveal Moulding Rear Belt
 & Garnish
 Plastic
 Chevrolet Impala & Caprice '87/
 UNIT PACKAGE 25



J76 4412

Replaces 20056132
 Clip Belt Moulding
 Cadillac Other General Motors
 Cars
 UNIT PACKAGE 100



J76 4264

Replaces 1660123
 Clip, Belt Moulding:
 General Motors Cars '75/
 UNIT PACKAGE 100

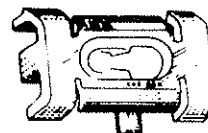

J79 5089

Replaces 20175051
 Clip, Quarter Belt Reveal Moulding:
 General Motors '80/
 UNIT PACKAGE 50



J80 5204

Replaces 20274997
 Clip Rear Quarter Belt
 Reveal Moulding
 General Motors '81/
 UNIT PACKAGE 100

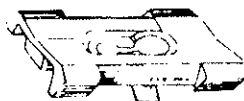

J81 5306

Replaces 20199675
 Clip, Belt Mouldings
 G.M. '80/, 'C' Body '85/
 UNIT PACKAGE 100

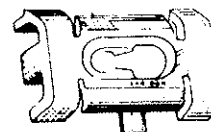

J83 5626

Replaces 20214807
 Clip, Moulding Outer Panel,
 Upper
 Oldsmobile, Pontiac '82
 UNIT PACKAGE 25

GM MOULDING CLIP



J77 4635

Replaces 20056133
Clip, Quarter Belt Reveal Moulding Outer:
General Motors
UNIT PACKAGE 100

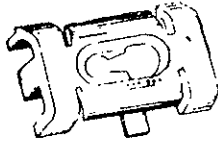

J86 6167

Replaces 1625122
Clip, Body Side Moulding.
Plastic
Cadillac "C" Body (fwd) '85.
UNIT PACKAGE 50



J85 5928

Replaces 20444101
Clip, Door Mouldings
Plastic
G.M. "C" Bodies '85/
UNIT PACKAGE 50



J80 5186

Replaces 20171942
Clip, Rear End, Belt Reveal
Moulding
(6 per Car)
Cadillac Fleetwood '80/
UNIT PACKAGE 25

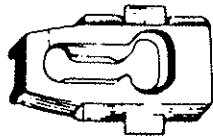

J77 4604

Replaces 468881
Retainer, Body Side Moulding:
General Motors
UNIT PACKAGE 100



J74 3955

Replaces 9838109
Clip, Door Peak Moulding, Body
Side Moulding:
All General Motors Cars
(Various Other Mouldings)
UNIT PACKAGE 100

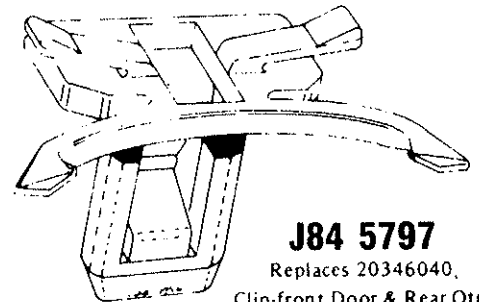

J84 5797

Replaces 20346040,
Clip-front Door & Rear Qtr.
Mldgs. (Front & Center)
GM Fiero "P" Body
1984 - Up
UNIT PACKAGE 25

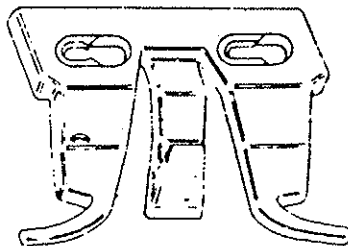

J84 5867

Replaces 20465159
Clip, Cowl Vent Panel to Fender
(Left)
Plastic
G.M. "A" Bodies '84/
UNIT PACKAGE 25

GM MOULDING CLIP



J81 5403

Replaces 22512114
Clip, Rocker Panel Moulding:
General Motors '82/
UNIT PACKAGE 50



J81 5402

Replaces 25500454
Clip, Rocker Panel Moulding:
General Motors '82/
UNIT PACKAGE 50

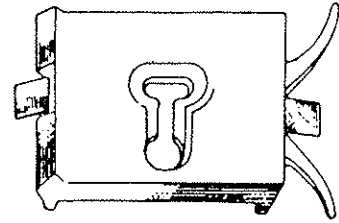

J86 6144

Replaces 14020781
Clip, Rocker Panel Moulding
Plastic
G.M. 'J' Bodies '82/
UNIT PACKAGE 25

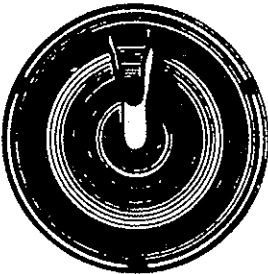

J70 3409

Replaces 3986976
Clip, Rocker
Panel Moulding
Chevrolet, Oldsmobile
UNIT PACKAGE 100



J80 5202

Replaces 22506785
Retainer, Rocker Panel Moulding
G.M. '81/
UNIT PACKAGE 50

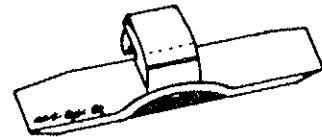

J86 6012

Replaces 94842802
Clip, Windshield Reveal
Moulding, Self Adhesive
(Orange Plastic)
G.M. Nova '85/
UNIT PACKAGE 10

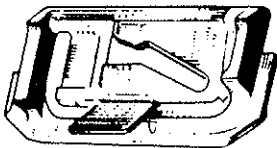

J73 3835

Windshield Reveal
Moulding Clip, Plastic:

UNIT PACKAGE 50

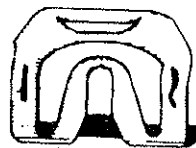

J70 3407

Replaces 9854717
Windshield and
Rear Window Reveal
Moulding Clip
UNIT PACKAGE 100



J70 3403

Replaces 8736591
Windshield and Rear
Window Reveal Moulding
Clip Vinyl Hard Tops
General Motors
UNIT PACKAGE 100

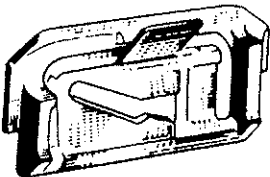

J74 4057

Replaces 1654047
Clip, Windshield Reveal Moulding
General Motors

UNIT PACKAGE 100



J76 4371

Replaces 20042718
Clip, Quarter Window Upper Reveal
Moulding:
General Motors '77/
UNIT PACKAGE 100

GM MOULDING CLIP



J74 3949

Replaces 8733059

Clip, Vinyl Top Moulding, Rear
Door Moulding Quarter Panel
Moulding: Rear Wheel Opening:

UNIT PACKAGE 100

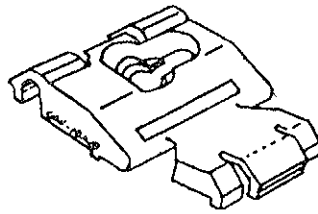

J86 6073

Replaces 20449759

Clip, Back Glass Reveal Moulding,
Plastic.

G.M. "N" Bodies '85

UNIT PACKAGE 50

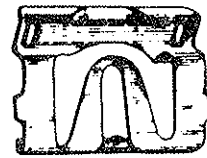

J72 3710

Replaces 9662950

Clip, Windshield Reveal Moulding:

General Motors

UNIT PACKAGE 100

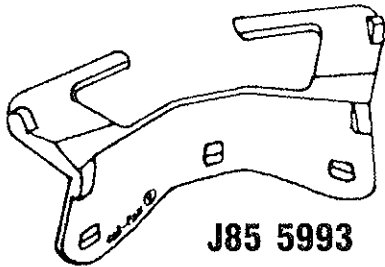

J85 5993

Replaces 75546-12020
94841436

Clip, Windshield Moulding
(Plastic)

Toyota Corolla '84/
G.M. Nova '85/

UNIT PACKAGE 25

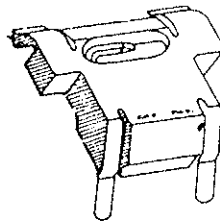

J83 5627

Replaces 20222445

Clip, Reveal Moulding, Quarter
Window, Lower

G.M. '82

UNIT PACKAGE 25

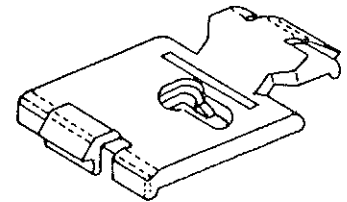

J87 6196

Replaces 20677328

Clip, Back Glass Reveal Moulding
Plastic.

Buick, Olds, Pontiac "H" Body fwd
'86

UNIT PACKAGE 25

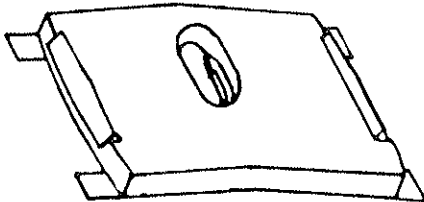

J87 6187

Replaces 20076165

Clip, Roof Transverse Moulding,
Plastic.

Buick Century & Regal '78/'80,
Olds, Cutlass '78/'80.

UNIT PACKAGE 25

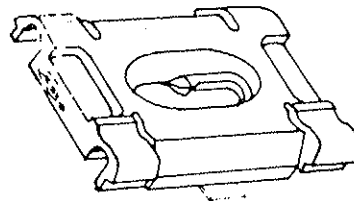

J85 5888

Replaces 20197203

Plastic

Clip, Roof Panel Cover Moulding

G.M. '84/

UNIT PACKAGE 50



J78 4830

Replaces 20133125

Clip, Moulding Finishing Roof
Panel Cover, Side:

General Motors

UNIT PACKAGE 50

GM MOULDING CLIP



J66 1175

T-Bolt, Used on Belt
Mouldings when Installing
Landau Tops

G M Cars

General Purpose

UNIT PACKAGE 100

GM LOCK



J78 4796

Replaces 3081052
469716 187 Rod Diameter
Clip, Door Lock Rod End
Chevrolet Vans '78/
UNIT PACKAGE 50



JSC 3197

(Replaces 4301446)
Remote Control Rod to
Door Lock Clip
Chevrolet, Oldsmobile, Pontiac
Buick, Cadillac '56/
UNIT PACKAGE 50

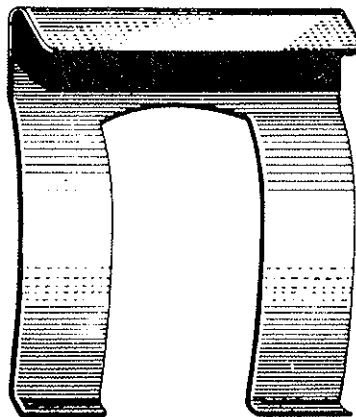

J71 3507

Replaces 9610100
Retainer, Front Door
Lock Cylinder
G.M. Cars
UNIT PACKAGE 25

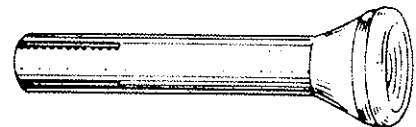

J81 5325

Black
Door Lock Knob
G.M. Vans and Trucks '71/
UNIT PACKAGE 25



J66 1197





Cap, Door Pillar Lock
Cylinder Case
General Motors '66
UNIT PACKAGE 100

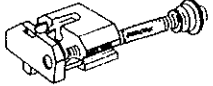
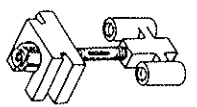
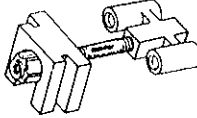
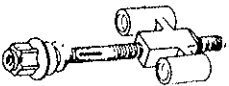
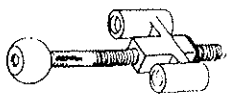
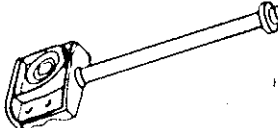

J82 5587

Replaces 20496885
Black
Cap, Door Pillar Lock
Cylinder Case
General Motors '82/
UNIT PACKAGE 50

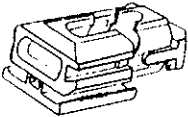
COMPOSITE HEADLAMP COMPONENT PARTS

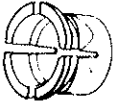
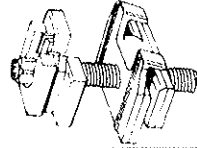
 <p>J991365* J991366* Adjusting Screw Assy Includes Screw & Slide UNIT PACKAGE 5</p> <p>*Depending on model, may be left or right side.</p>	 <p>J991368 Adjusting Screw Assy Includes Screw, Nut & Retainer UNIT PACKAGE 5</p>	 <p>J991369 Adjusting Screw Assy Includes Screw, Nut & Retainer UNIT PACKAGE 5</p>
 <p>J991370 Adjusting Screw Assy Includes Screw & Nut UNIT PACKAGE 5</p>	 <p>J991371 Adjusting Screw Assy Includes Screw & Nut Use w/88-6378 Socket UNIT PACKAGE 5</p>	 <p>J991372 Clear Assembly Headlamp Adjusting UNIT PACKAGE 1</p>
 <p>J991374 Replaces 16501548 Crommel Nut & Spring Provides Tension On Headlamp Various Models G.M. UNIT PACKAGE 25</p>	 <p>J991375 Replaces 16507939 Crommel Nut & Spring W/Drive Pin Provides Tension On Headlamp "C-K" Trucks G.M. UNIT PACKAGE 15</p>	 <p>J991376 Slide Pivot Assy Includes Slide w/Lock & Pin UNIT PACKAGE 15</p>
 <p>J991377 Center Pivot Headlamp Adjusting UNIT PACKAGE 10</p>	 <p>J991378 Socket Adjusting Screw Use w/88-6371 Screw Assy UNIT PACKAGE 25</p>	 <p>J991477 Replaces 16510834 Headlamp Adjusting Screw Assy Includes Screw, Nut & Retainer Composite Headlamp Assembly G.M., Olds "C & H" Body, '87 UNIT PACKAGE 5</p>

TYPICAL COMPOSITE HEADLAMP

PART NUMBER	REPL. GM PART NUMBER	UNIT PKG.	DESCRIPTION	DIVISION & MODEL APPLICATION BY BODY CODE				
				BUICK	CADILLAC	CHEVROLET	OLDSMOBILE	PONTIAC
J991365	16504041 (L)	5	ADJ. SCREW ASSY		E-K		C-H-N	N
	16505012 (R)			C				
J991366	16504042 (R)	5	ADJ. SCREW ASSY		E-K		C-H-N	N
	16505011 (L)			C				
J991368	16505355	5	ADJ. SCREW		C			
J991369	16509247	5	ADJ. SCREW					N
J991370	16508801	5	ADJ. SCREW				N	
J991371	16506585	5	ADJ. SCREW			L		
J991372	16508139	1	GEAR ASSY	C	C-E-K	G	C-H-N	N-W
J991376	16506783	15	SLIDE PIVOT	C	C-E-J-K	G	C-H-N-W	N-W
J991377	16505578	10	CENTER PIVOT	C	C-E-J-K	G	C-H-N	N
J991378*	16508845	25	SOCKET			L		

- USE WITH J991378 *USE WITH J991371

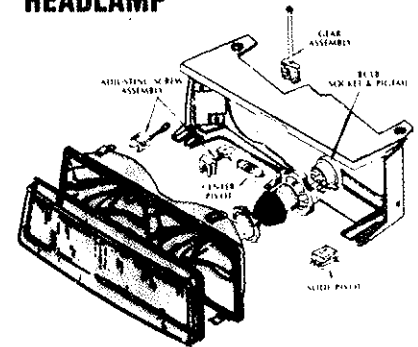

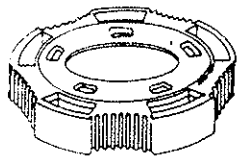

J991373
Replaces 16505888
Retainer, 9004 Headlamp
Composite Headlamp Assembly
G.M. Cars
UNIT PACKAGE 5

GM HEADLAMP

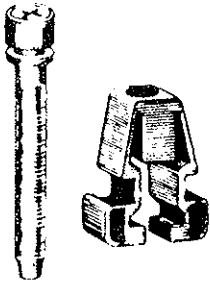

J71 3438

Replaces 1600375
Headlight Adjusting Nut
and Screw

UNIT PACKAGE 25

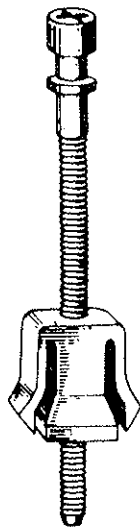

J75 4228

Replaces 362378
Black
Headlamp Adjusting Screw and Nut
Assembly
Chevrolet
UNIT PACKAGE 25

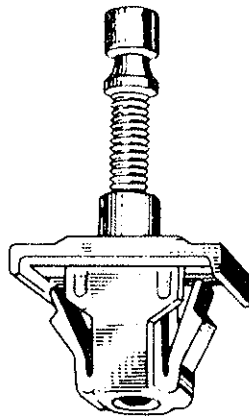

J76 4242

Replaces 500267
Headlamp Adjusting Screw
& Nut Assembly:
Pontiac
UNIT PACKAGE 25

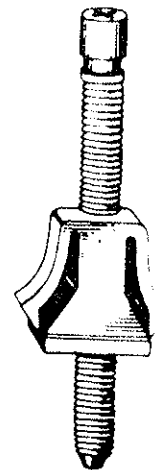

J76 4252

Replaces 365266
Headlamp Screw and Nut Assembly:
Chevrolet Caprice Full Size Cars
UNIT PACKAGE 25

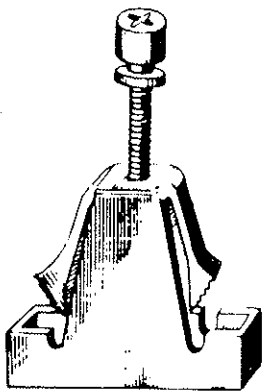

J76 4395

Replaces 557057
12-28 x 1 3/4 Screw Size
Headlamp Adjusting Screw and
Nut Assembly
Pontiac '77/
UNIT PACKAGE 25

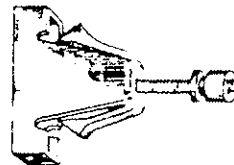

J85 5915

Replaces 22512857
Headlamp Adjuster Assembly
(White Nut)
Slotted Torx Screw M5 x 35mm
G.M. 'B', 'C', 'G', 'E' & 'X' Bodies
'82/
UNIT PACKAGE 10

J76 4380

Replaces 556539
Screw Size 12-28 x 1 3/8"
Headlamp Adjusting Screw and Nut
Assembly:
Oldsmobile, Buick
UNIT PACKAGE 25

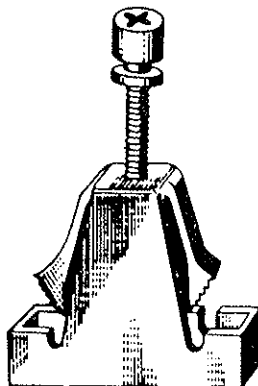

J76 4381

Replaces 556196
Screw Size 12-28 x 1 3/8"
Headlamp Adjusting Screw and Nut
Assembly:
Oldsmobile
UNIT PACKAGE 25

GM HEADLAMP

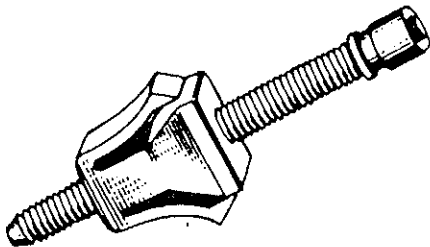

J75 4226
 Replaces 364574
 White
 Headlamp Adjusting Screw and Nut
 Assembly:
 Buick
 UNIT PACKAGE 25

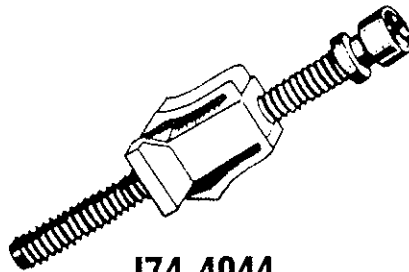

J74 4044
 Replaces 343541
 Headlamp Adjusting
 Screw and Nut:
 UNIT PACKAGE 25



J74 4076
 Replaces 354076
 Headlamp Adjusting
 Screw & Nut:
 Buick '75
 UNIT PACKAGE 25

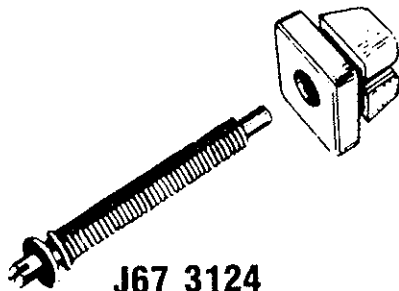

J67 3124
 Headlamp Beam
 Adjusting Screw & Nut:
 UNIT PACKAGE 25
 KITS



J72 3754
 Replaces 1235816
 Headlamp Adjusting
 Screw and Nut:
 UNIT PACKAGE 10

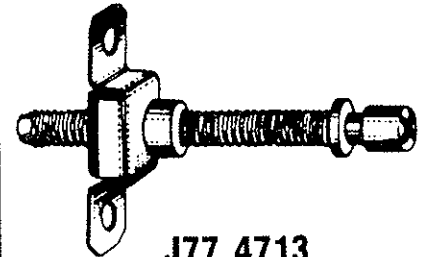

J77 4713
 Replaces 1252690
 Screw Size 1/4-28 x 1 5/8"
 Headlight Adjusting Screw and Nut
 Assembly:
 Buick
 UNIT PACKAGE 25

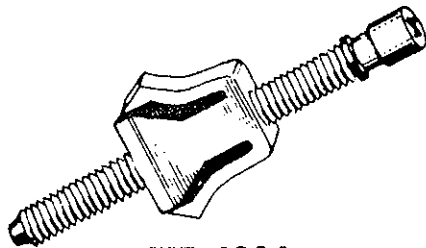

J75 4224
 Replaces 343543
 White
 Headlamp Adjusting Screw and Nut
 Assembly:
 Chevette
 UNIT PACKAGE 25

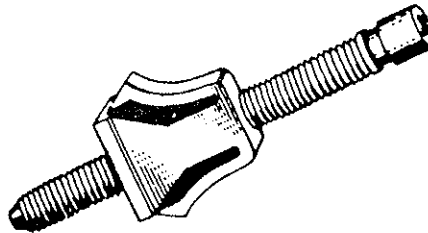

J75 4225
 Replaces 343544
 Blue
 Headlamp Adjusting Screw and Nut
 Assembly:
 Chevrolet
 UNIT PACKAGE 25

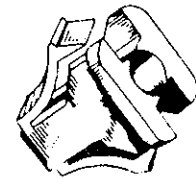

J78 4808
 Replaces 365270
 Nut, Headlamp Adjusting,
 For Use on Fibreglas Panels:
 General Motors Cars:
 UNIT PACKAGE 50

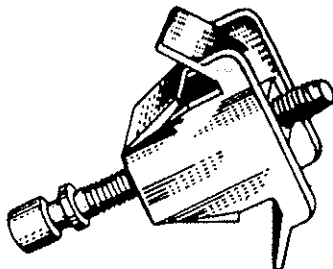

J76 4245
 Replaces 550092
 Headlamp Adjusting
 Screw and Nut Assembly:
 Oldsmobile, Cadillac
 UNIT PACKAGE 25

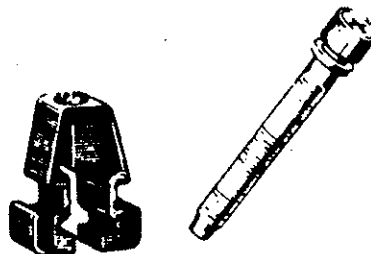

J76 4313
 Replaces 1606642
 Headlamp Adjusting Screw and Nut
 Assembly:
 Cadillac '75/
 UNIT PACKAGE 25

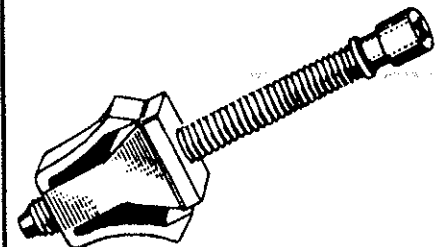

J75 4227
 Replaces 364576
 Blue
 Headlamp Adjusting Screw and Nut
 Assembly:
 Buick
 UNIT PACKAGE 25

GM HEADLAMP

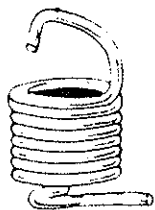

J77 4571
 Replaces 1238106
 Headlamp Tension Spring;
 Buick 76/ Century, Riviera,
 All (Except Skylark and Century 4 Doors).
 UNIT PACKAGE 25

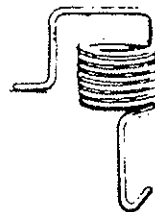

J82 5533
 Replaces 10013753
 Spring, Headlight Adjusting
 G.M. 'J' Cars '82/
 UNIT PACKAGE 25

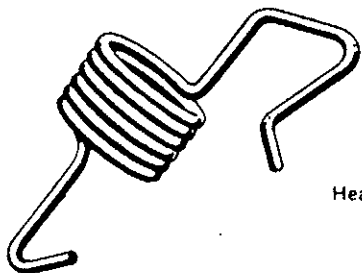

J71 3474
 Replaces 480773
 Headlamp Adjusting Spring:
 UNIT PACKAGE 25

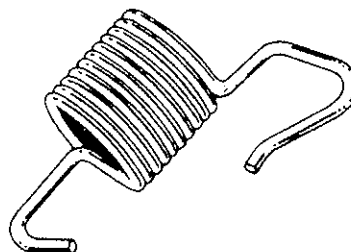

J77 4702
 Replaces 549398
 Headlight Tension Spring
 Pontiac '78/
 UNIT PACKAGE 25

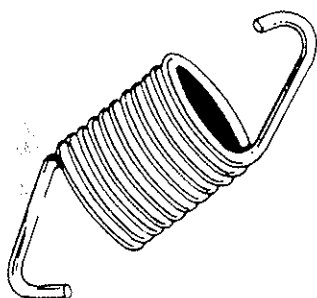

J77 4701
 Replaces 463574
 Headlight Tension Spring
 Pontiac '78/
 UNIT PACKAGE 25

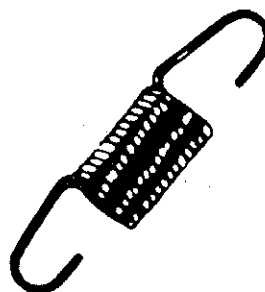

J74 3990
 Replaces 345559
 Spring, Headlamp Adjusting
 UNIT PACKAGE 25

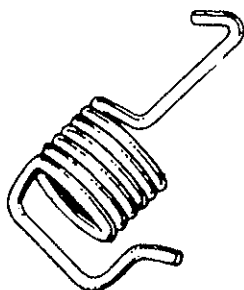

J75 4218
 Replaces 554459
 Spring, Headlamp Adjusting:
 Oldsmobile 76/
 UNIT PACKAGE 25

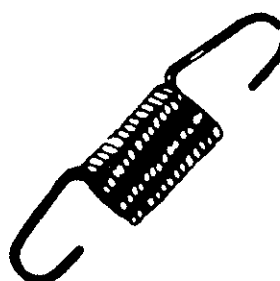

J72 3686
 Replaces 3987016
 Headlamp Adjusting Spring
 UNIT PACKAGE 25

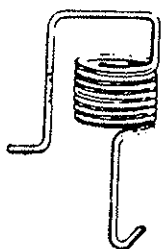

J74 4099
 Replaces 419231
 Spring, Headlamp Adjusting
 Olds '75, 'C' & 'E' Bodies RWD
 UNIT PACKAGE 25



J74 3989
 Replaces 345510
 Spring, Headlamp Adjusting
 UNIT PACKAGE 25

GM TRIM CLIP

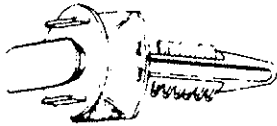

J85 5956

Replaces 15596301
Clip, Door Trim Panel
Side Rear Door
Plastic
GM "M" Van '85
UNIT PACKAGE

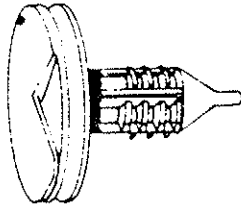

J85 5941

Replaces 20429451
Clip, Door Trim Panel
Plastic
GM Fiero "P" Body '84
UNIT PACKAGE 100

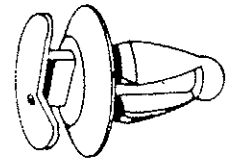

J85 5961

Replaces 7703-077-111
Clip, Door Trim Panel
AMC, Encore & Alliance '85/
UNIT PACKAGE 50

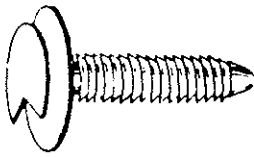

J77 4622

Replaces 363137
Trim Panel Clip:
Chevrolet and GMC Pick Up Trucks 77/
UNIT PACKAGE 100

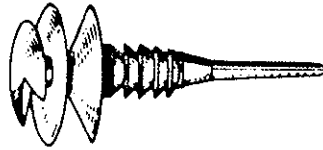

J74 3979

Not Supplied from OEM
Fastener, Door Trim Pad, (with
Extended Lead for Hard to Reach
Installations):
General Motors Cars
UNIT PACKAGE 100

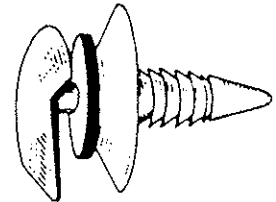

J77 4629

Replaces 3065575
Clip, Door Trim Panel:
Cadillac 77/, General Motors Cars 78/
UNIT PACKAGE 100

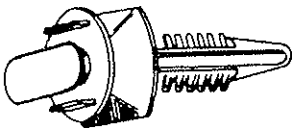

J83 5617

Replaces 20421800
Clip, Door Panel Retaining
G.M. '83
UNIT PACKAGE 25

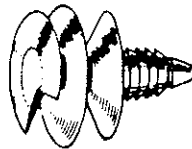

J70 3398

Replaces 9818648
Panel Fastener, Nylon:
General Motors Cars
UNIT PACKAGE 100

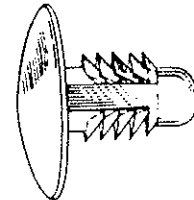

J80 5158

Replaces 1619321
Black
Clip, Vinyl Splash Shield Radiator
to Bar
G.M. '80/
UNIT PACKAGE 50

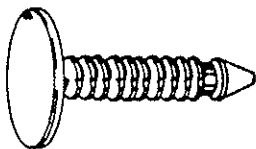

J85 5937

Replaces 20514862
Plastic
Retainer, Grille to Shroud, Vent
Grille to Windshield Shroud
G.M. 'N' Body '85/
UNIT PACKAGE 100

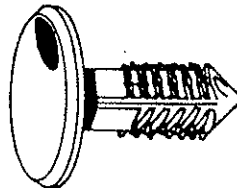

J85 5957

Replaces 15594416
Retainer, Bumper End Cap
Plastic
G.M. 'M' Van '85/
UNIT PACKAGE 50

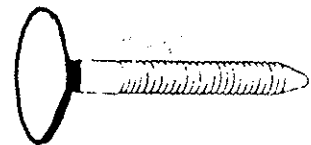

J85 5990

Replaces 20430421
Trim Clip, Door Panel
G.M. 'N' Bqdy '85/
UNIT PACKAGE 50

GM TRIM CLIP



J86 6182

Replaces 94797292
Trim Retainer.
Tan Plastic.
Pontiac LeMans '87/
UNIT PACKAGE 50

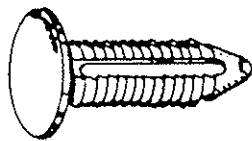

J86 6059

Replaces 1631564
Retainer Bumper Fascia
(Black Plastic)
10mm Dia. x 28mm Length
21mm Head Dia.
G.M. 'C' Bodies '85/
UNIT PACKAGE 50

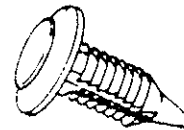

J991502

Replaces N805155-S
Clip, Door Trim Panel
1/4" Hole Dia. 3/32" Panel Thickness
1/16 to 9/16" Grip Range
Black Plastic.
Ford Various Models '88/
UNIT PACKAGE 50

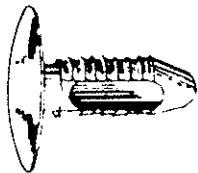

J81 5428

Replaces 22512276
Clip, Bumper Strip Retaining
G.M. '80/ Rear Bumper Fascia
'C' Body '85/
UNIT PACKAGE 50

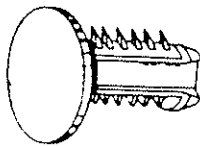

J84 5768

Replaces 25517947
Retainer Front Fender Splash
Shield to Body Frame Member
G.M. 'A' Body
UNIT PACKAGE 25



J82 5504

Black
Screw, Interior Trim:
Camaro and Firebird '82/
General Use on G.M. Cars
Use With CAR PAK - 82-5505
UNIT PACKAGE 25

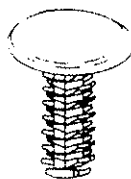

J84 5795

Replaces 20511451
Retainer Cowl Vent
.185 Hole
G.M. Fiero 'P' Body '84-Up
UNIT PACKAGE 25



J64 1002

(Replaces 4841194)
Fastener, Door Weather-
strip, Nylon:
UNIT PACKAGE 100

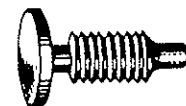

J72 3749

Replaces 411700
Retainer, Flex Filler Between
Impact Bumper and Fender:
UNIT PACKAGE 100



J77 4691

Replaces 25016383
Dash Panel Filler Clip. Also
General Purpose.
General Motors '77/
UNIT PACKAGE 50



J70 3422

Replaces 8731909
Weatherstrip Clip.
UNIT PACKAGE 100





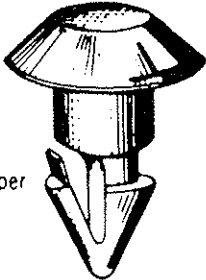
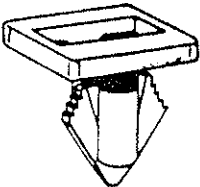
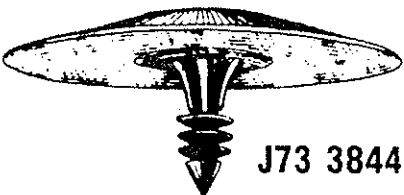
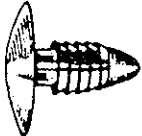
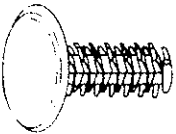
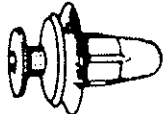

J64 1003

(Replaces 4876498)
Clip, Nylon, Weather-
strip Door Opening
Fastener:
UNIT PACKAGE 100

GM TRIM CLIP

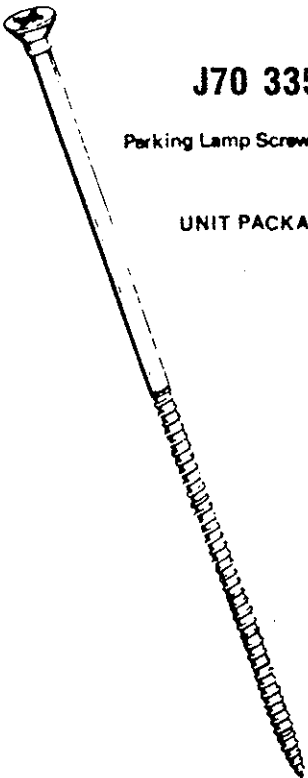
<p>J77 4720</p> <p>Replaces 10003608 Retainer, Front and Rear Bumper Splash Shield Pontiac '78/. UNIT PACKAGE 50</p> 	<p>J991470</p> <p>Replaces 20653699 Trim Clip: Upper Door Panel M4.2 Screw Hole: Plastic G.M. Corsica '87/. UNIT PACKAGE 25</p> 	<p>J73 3844</p> <p>Replaces 3977775 Clip, Hood Insulation: General Motors Cars UNIT PACKAGE 100</p> 
<p>J71 3499</p> <p>Replaces 6270163 (GRAY) Retainer, Rear Bumper Center Filler Chevrolet 72/. Buick and Cadillac Chrysler Products</p> 	<p>J84 5795</p> <p>Replaces 20511451 Retainer Cowl Vent .185 Hole G.M. Fiero 'P' Body '84-Up UNIT PACKAGE 25</p> 	<p>J81 5415</p> <p>Replaces 67771 12010 F, 95005064 Clip, Trim Panel G.M. Nova '85/. Toyota UNIT PACKAGE 25</p> 

GM MISC. SCREW

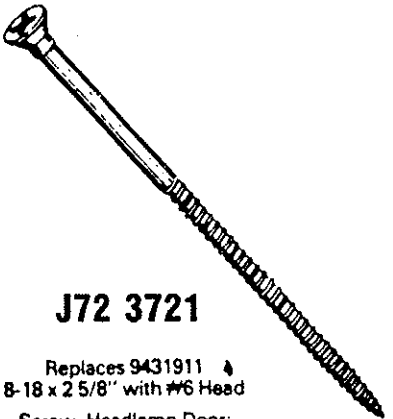
<p>J70 3351</p> <p>Parking Lamp Screw, 4" Length: UNIT PACKAGE 50</p> 	<p>J72 3746</p> <p>Replaces 9879001 #8 x 1/2 Hex Washer Head with Phillips Recess Weatherstrip and Trim Screw: UNIT PACKAGE 100</p> 	<p>J73 3888</p> <p>Replaces 588546 Screw, Quarter Wheel House Moulding or Guard Stainless Steel Chrome Plated Type AB Point 8- 1/2" UNIT PACKAGE 100</p> 
<p>J86 6064</p> <p>Replaces 20423550 381801-52 Screw Phillips Washer Head Self Drilling No. 8 x 1/2" w/ 7/16" Dia. Washer Head Black Phosphate Finish Wheel Opening Moulding and Other Applications Ford, G.M. & General Purpose UNIT PACKAGE 100</p> 	<p>J72 3721</p> <p>Replaces 9431911 4 8-18 x 2 5/8" with #6 Head Screw, Headlamp Door: UNIT PACKAGE 50</p> 	

GM RIVET

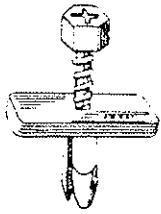

J80 5256

Replaces 14017689
Rivet, Parking Lamp;
General Motors '81/
UNIT PACKAGE 50



J78 4903

Replaces 22500586
Rivet, Radiator Shroud;
General Motors '79/
UNIT PACKAGE 50



J84 5794

Replaces 20451119
Rivet Screw Type
5/16 in. Hole
.138 - .354 Panel Range
Front Compartment Spare Tire
G.M. Fiero 'P' Body '84-Up
UNIT PACKAGE 25

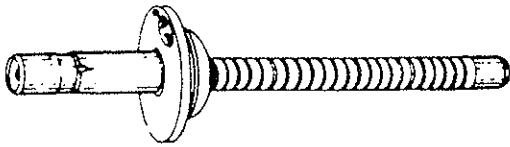

J85 5933

Rivet, Aluminum w/ Aluminum Mandrel
1/4" Dia 5/16" Grip Range
1 1/2" Dia Belleville Washer
(Black)
G.M. Fiero 'P' Various Fender,
Rocker & Quarter Panel Application
UNIT PACKAGE 10

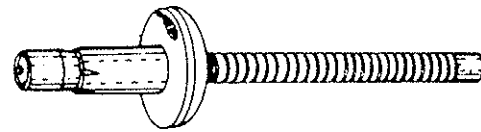

J85 5934

Rivet, Aluminum w/ Aluminum Mandrel
1/4" Dia 5/16" Grip Range
1 2" Flange
(Black)
G.M. Fiero Various Body Applications
UNIT PACKAGE 25

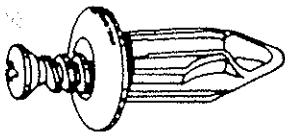

J86 6060

Replaces 1633999
Rivet, Screw Type
(Black Plastic)
Hole Size 10mm
Panel Range 9mm - 15mm
Washer Face Dia. 21mm
G.M. Various Panel Attach.
UNIT PACKAGE 25

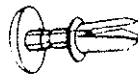

J83 5638

Replaces 6500787-Chrysler
Black Plastic
16500308
Blind Rivet, Interior Trim and
Mini Van Tailgate Door
Chrysler '82
Drive Rivet, Exterior Rear
Fascia
G.M. '82
UNIT PACKAGE 25

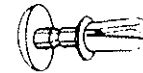

J83 5637

Replaces 16500283
Plastic
Chrome Capped, Drive Rivet
Trunk Interior
G.M. '83
UNIT PACKAGE 25

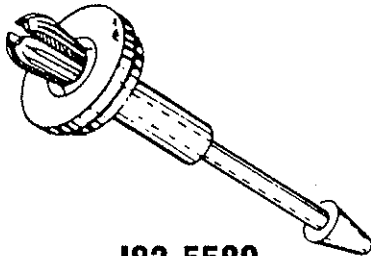

J82 5589

Replaces 14039971
Retainer, Cowl Top Vent
Retainer
Chevrolet & GMC Pick-Up Truck
'81/
UNIT PACKAGE 25

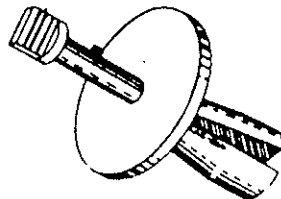

J82 5484

Replaces 14039420
Rivet
G.M.
UNIT PACKAGE 50



J86 6089

Replaces 9440392
Rivet, Steel w/ Steel Mandrel
Dome Head 3/16" Rivet
1/8 - 1/4" Grip Range
3/8" Flange
Zinc Chromate Plate
G.M., Various Applications
and General Purpose
UNIT PACKAGE 100

GM RIVET

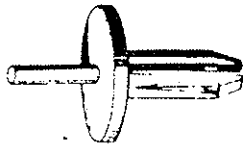

J78 4802

Replaces 472434
Rivet, Splash Shields:
General Motors Products
UNIT PACKAGE 50

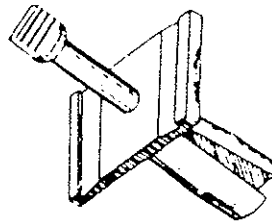

J82 5485

Replaces 14032200
Rivet
G.M.
UNIT PACKAGE 50

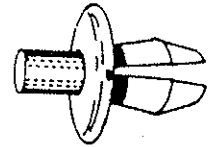

J86 6175

Replaces 90138810
Rivet, Drive Type
M8 Hole; 2.0-6.0mm Panel Range; 16mm
Washer Face.
Plastic
Pontiac LeMans '87/
UNIT PACKAGE 25

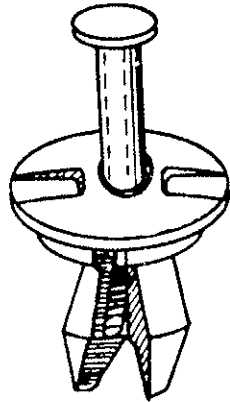

J81 5433

Replaces 5973400 - 1/8" Shoulder
Rivet, Front and Rear Bumper Energy
Absorbing Strip:
General Motors: '81 Monte Carlo and
All '82/. 10 used per Car.
UNIT PACKAGE 25

J78 4917

Replaces 14003794
Rivet, Front End Filler Flap:
General Motors 79/.
UNIT PACKAGE 100



J991310

Replaces 10069112
Blind Rivet, Super Tough Nylon
6.6mm Hole Dia.; 1-4mm Panel Range
21mm Hd. Dia.; 10mm Shoulder Dia.
Bumper Fascia
G.M. "L" Body '87/.
UNIT PACKAGE 25

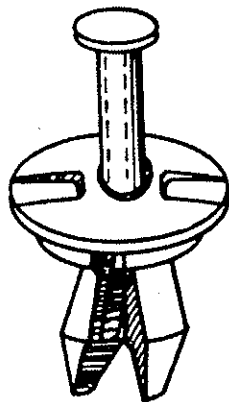
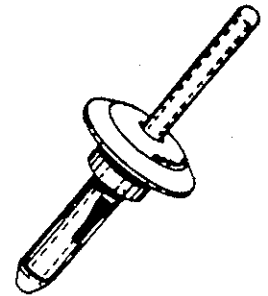

J81 5434

Replaces 5973823 - 3/16" Shoulder
Rivet, Front and Rear Bumper, Energy
Absorbing Strip:
General Motors '81 Monte Carlo and
all '82/. 10 used per Car.
UNIT PACKAGE 25

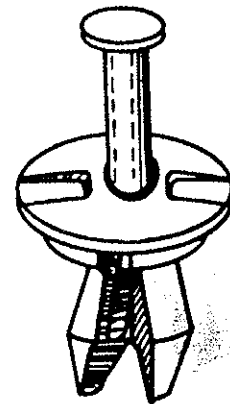

J81 5435

Replaces 5973996 - 1/4" Shoulder
Rivet, Front and Rear Bumper, Energy
Absorbing Strip:
General Motors '81 Monte Carlo and
all '82/. 10 used per Car.
UNIT PACKAGE 25

GM RIVET

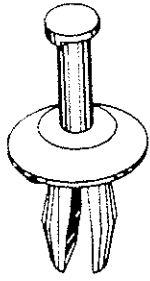

J82 5486

Replaces 14019206
Rivet
General Motors
UNIT PACKAGE 50

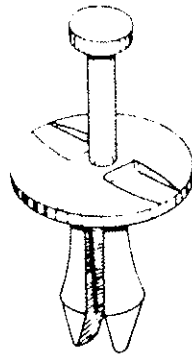

J83 5634

Replaces 14045480
Black Plastic
Retainer Front Facia Attachment
Chevrolet 'A' Car '82
UNIT PACKAGE 25

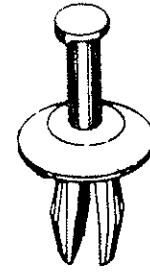

J83 5663

Replaces E3DZ-14A163A
14019205, 14019206,
8934-201-621
Black Plastic
Blind Rivet, General Purpose
Ford, G.M., American Motors
UNIT PACKAGE 25

GM WINDOW

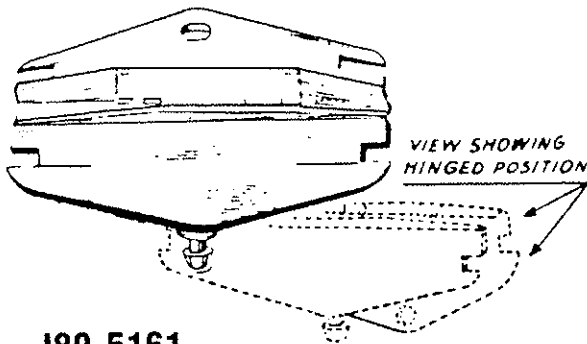

J80 5161

Replaces 20123070, 20328600
Guide, Front Door Window
G.M. '80/, Buick, Cadillac and
Olds 'B', 'C' & 'X' Bodies
UNIT PACKAGE 25

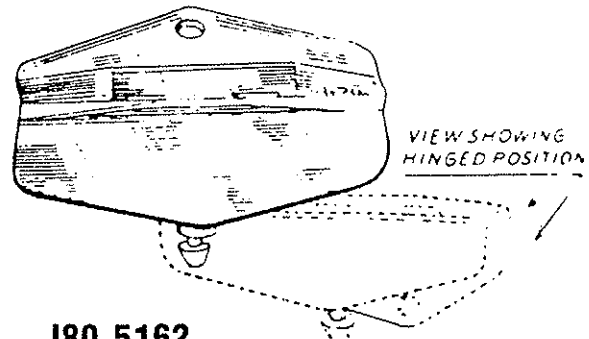

J80 5162

Replaces 20160591
Guide, Rear Door Window
G.M. '80/ Wagons 'B', 'C' & 'X'
Bodies
UNIT PACKAGE 25

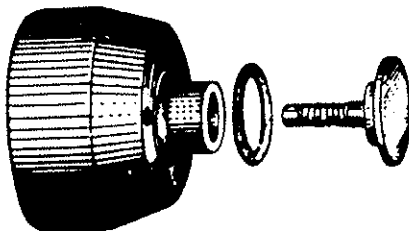

J73 3840

Not Supplied By OEM
Window Crank Handle Repair
Knob And Attaching Parts:
General Motors Cars 70/. (CLEAR)
UNIT PACKAGE 12

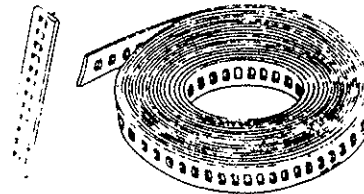

J84 5769

Replaces 20435391
20161228
Tape-window Regulator
Elastomeric Tape
GM 'A', 'B', 'C' & 'X'
Bodies 1980-Up. With
Tape Controlled Systems
UNIT PACKAGE 1 ROLL
20 foot length in Dispenser
Type Box

GM NUT



J80 5179

Replaces GM 1259296
Ford D7VZ-6050074A
Nut, Plastic, Barrel Type,
For Tee Type Moulding Clips:
Ford, General Motors, etc.
UNIT PACKAGE 100

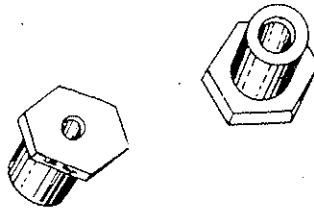

J81 5303

Nut, Header Panels, General Purpose:
General Motors
UNIT PACKAGE 50



J80 5153

Replaces 25501771
Nut, Headlamp Bezel Retaining:
Oldsmobile '80/.
UNIT PACKAGE 100



J76 4258

Replaces 3061114
Nut, Plastic Push in Name Plates and Insignia:
General Motors Cars
UNIT PACKAGE 100



J75 4200

Nut Headlamp Bezel
(Nylon)
G.M. Cars, Also General Purpose
UNIT PACKAGE 100

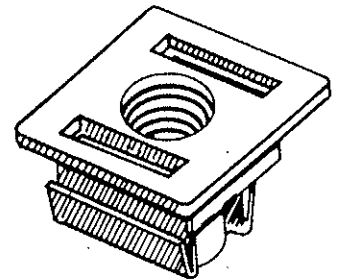

J86 6011

Replaces 94842543
Nut, Plastic M4 Screw Size
Fits 7mm Sq. Hole.
Parking & Marker Lamp Retaining &
General Use.
G.M. Nova '85/.
UNIT PACKAGE 50



J77 4554

Not Supplied by OEM
Nut (Nylon) Parking Lamp Bezel
G.M. Cars '76/
UNIT PACKAGE 100

J82 5505

WHITE
Anchor, For Interior Trim
Use with CAR PAK - 82-5504
Firebird and Camaro '82/.
General Use on G.M. Cars
UNIT PACKAGE 25

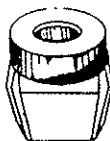

J81 5369

#10 Screw Size
Plastic Push in Nut, with Oblong Base:
General Motors and General Purpose
UNIT PACKAGE 100



J85 5955

Replaces 25525798, 8934-201-235
Nut. (Wide Range) For 4.2mm Screw
(Plastic) Grill Retaining
G.M. 'C' Bodies '85/
AMC Alliance, Encore '85/
UNIT PACKAGE 50

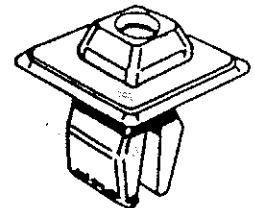

J86 6179

Replaces 90186857
Nut; Plastic
7mm Sq. Hole, M5 Screw
Pontiac LeMans '87/.
UNIT PACKAGE 25

GM NUT



J77 4531

Replaces 1254815
Plastic Anchor Nut To Fenders
Cornering Lights
Buick '77/
UNIT PACKAGE 100

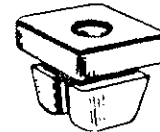

J67 3130

(Replaces 3907444)
Nut, License Plate,
Plastic
General Motors Cars
'65/
UNIT PACKAGE 100



J67 3122

(Replaces 3921446)
Headlamp Beam
Adjusting Nut:
General Motors Cars
UNIT PACKAGE 50



J80 5260

Not Supplied by OEM
Nut, Headlamp Doors and
Header Panel:
General Motors -80/
UNIT PACKAGE



J68 3252

Replaces 3893980
Nut, Grille Attaching,
Nylon
Chevrolet
(14 used per car)
UNIT PACKAGE 100



J71 3517

Replaces 3899596
Grille Nut, Nylon:
UNIT PACKAGE 100

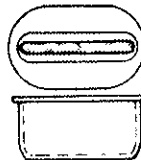

J9401

Pontiac 1377030
Bumper Insulator, Panel Retainer
Chev. Headlamp Screw Retainer
UNIT PACKAGE 25



J72 3606

Replaces 3986978
Headlamp Door Retainer Nut:
Chevrolet
8 Used per Car
UNIT PACKAGE 100



J78 4924

Retainer, Truck and RV Vehicle Outside
Rear View Mirror:
General Motors and GMC
UNIT PACKAGE 50



J86 6057

Replaces 1623436
Nut, (Jacknut) M5 Thread,
Zinc Finish w/ Raintite
G.M. Body Rack Mounting
and General Purpose
UNIT PACKAGE 25

J86 6058

Replaces 14007940
Nut (Jacknut) M6 x 1" Thread
Zinc Finish w/ Raintite
G.M. Roof Rack Mounting
General Purpose
UNIT PACKAGE 25

GM PIGTAIL

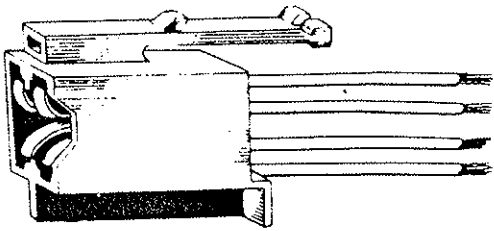

J78 4928

Pigtail, Radio Harness, Front Speaker:
General Motors
UNIT PACKAGE 6

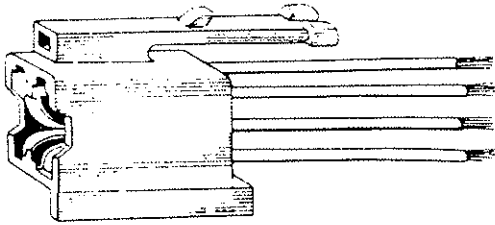

J78 4926

Pigtail, Radio Repair, Rear Speaker:
General Motors
UNIT PACKAGE 6

J73 3847

Not Supplied By OEM
Pigtail Set, Radio Lead-in:
General Motors Cars 71-77.
(Used Primarily in Patch Ups
When Radio Is Stolen)

UNIT PACKAGE 12

CONSISTS OF 1 EACH OF
73-3849
73-3881
73-3882

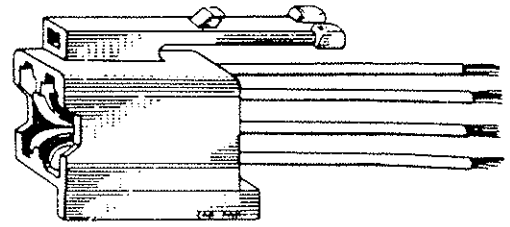
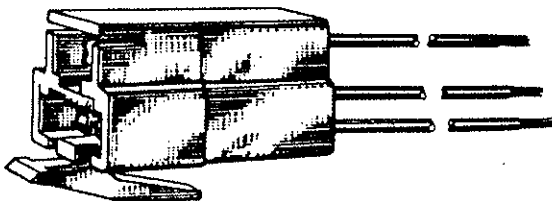
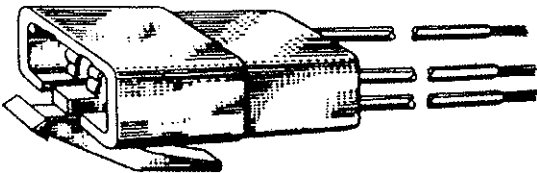
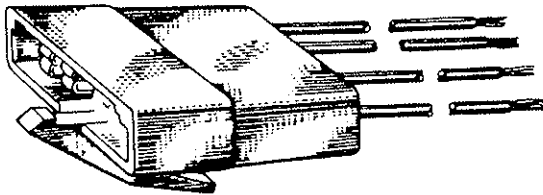

J78 4925

Pigtail Kit, to repair Radio Harness:
General Motors
UNIT PACKAGE 6

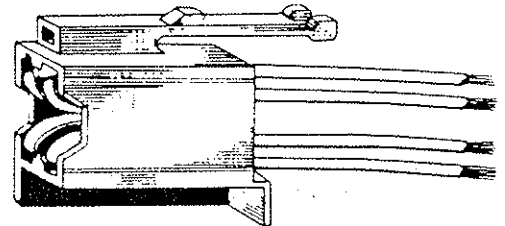
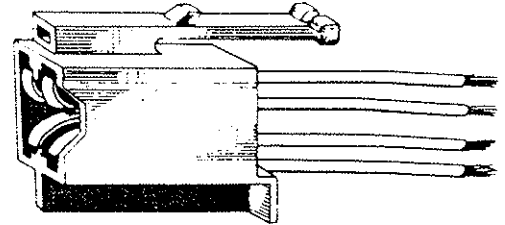

RADIO PIGTAIL SOCKET KIT J991343

Replaces 12058478
Radio Pigtail Socket Kit
Contains 4 Pigtail/Connectors
1 Black — 10 Way
1 Black — 4 Way
1 Gray — 2 Way
1 Blue — 4 Way
All Leads are Color Coded & 10" Long
G.M. w/E.T.R. Radios '86
UNIT PACKAGE 1 ASSEMBLY

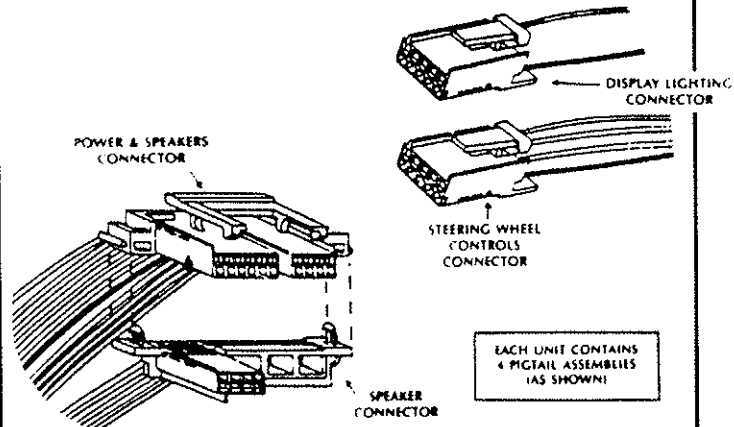

EACH UNIT CONTAINS
4 PIGTAIL ASSEMBLIES
(AS SHOWN)

GM PIGTAIL

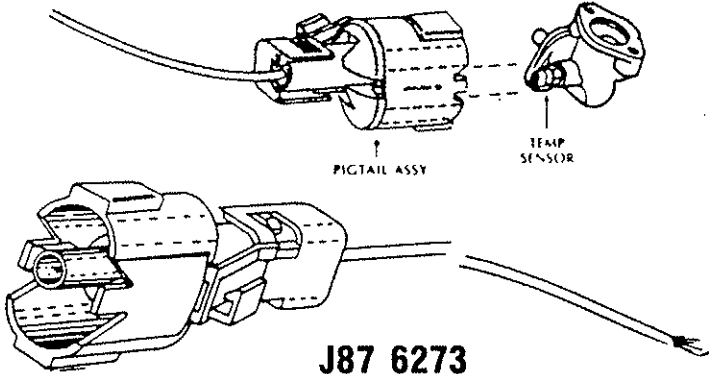

J87 6273

Replaces 12051234
Pigtail, A/C Compressor Coolant
w/10" Lead
Fan Temp. Switch.
On Engine or Hsq.
GM Products '82
UNIT PACKAGE 6

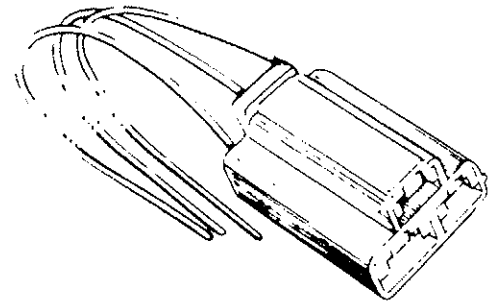

J68 3210

Not Available From OEM
Dimmer Switch Pigtail.
Avoids Replacing Entire
Instrument Panel Harness:
G.M. '66/.
UNIT PACKAGE 10

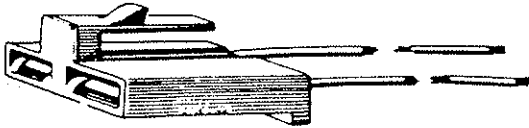

J72 3744

Not Available from OEM
Pigtail, Alternator
General Motors Cars
Alternators with Built in
Voltage Regulator '71 up
UNIT PACKAGE 12

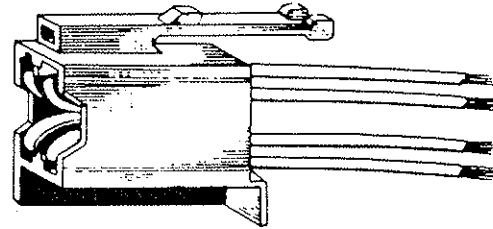

J78 4927

Pigtail, Radio Harness, Power Supply:
General Motors
UNIT PACKAGE 6

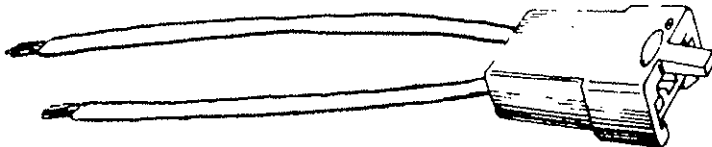

J85 5975

Pigtail Radio Repair 10" Leads
Speaker & Power Supply
(ETR Radio)
G.M.
UNIT PACKAGE 10

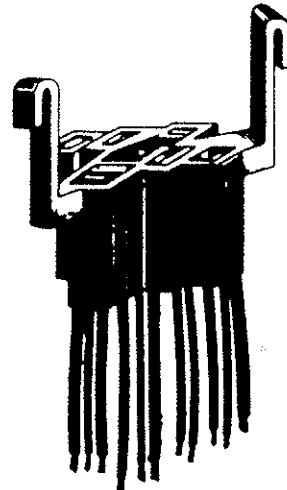

J72 3673

Not Supplied by OEM
Ignition Pigtail
Chevrolet Trucks, C-10-20,
D-10-20 Models
'67-'74
UNIT PACKAGE 6

GM U-NUT STANDARD

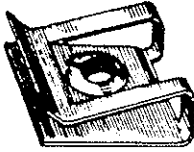

J74 3938

Replaces 9431532
Screw Size $\frac{1}{4}$ "-14, Panel Range
.025-.150

Wide Range U-Nut, Radiator
Fan Shroud, Instrument Panel,
Carrier to Front Bumper Filler
Bracket, Power Hose Clip, Ignition
Pulse Amplifier, Ingate Trim Panel,
Coolant Recovery Tank, Wind-
shield Washer Jar, Fuel Filler Door,
Carburator Air Inlet (truck):

**Chevrolet & Pontiac '71 - '75.
Also General Purpose.**

UNIT PACKAGE 100

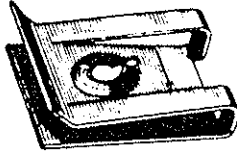

J74 3942

Replaces 9433043
Screw Size $\frac{1}{4}$ "-14 Panel Range
.025-.150

Wide Range U-Nut, Transmission
Control Console, Front Bumper
Air Deflector, Front Fender Nut,
Radiator Grille, Parking Lamp
Front Bumper, Front Bumper
Valance Panel.

**Chevrolet & G.M.C. Truck.
'71 - '75. Also General Purpose**

UNIT PACKAGE 100

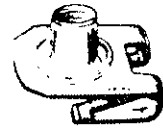

J85 5985

Replaces 339715
Nut, Shock Absorber End
Screw Size $\frac{5}{16}$ " - 18
G.M. '74/

UNIT PACKAGE 50



J86 6016

Not Supplied
Nut, 'U' Type No. 8 Screw
Panel Range .070 - .100
Width $\frac{7}{16}$ " x $\frac{3}{8}$ " Length
G.M. Headlamp Bezel and
Side Marker Bezel to Panel
UNIT PACKAGE 100



J74 3937

Replaces 9433155
Screw Size #8-18, Panel Range
.025-.150

Wide Range U-Nut, Front Fender
Bumper Filler:

**Chevrolet & Pontiac X Bodys
Also General Purpose.**

UNIT PACKAGE 100

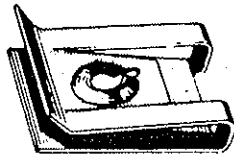

J74 3939

Replaces 3849974
Screw Size $\frac{1}{4}$ "-14 Panel Range
.100-.250

Wide Range U-Nut, Radiator
Shrouds:

**General Motors Cars
UNIT PACKAGE 100**

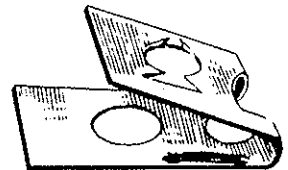

J81 5320

Replaces 10005510
Nut, Front Bumper (Impact Strip) and
Letters:

**Pontiac Lemans '78/
Nut, Rear Bumper (Impact Strip):**

**General Motors "X" Cars '80/
UNIT PACKAGE 100**



J74 3974

Replaces 325822
#8 Tapping Screw Size

Nut, Headlight Door, Front
Speaker Bracket:

**Chevrolet Vega. General
Purpose.**

UNIT PACKAGE 100



J74 3975

Replaces 3939394
14 Tapping

Nut, Long Throat, Shrouds,
Fenders, Etc:

**General Motors Cars. General
Purpose.**

UNIT PACKAGE 100

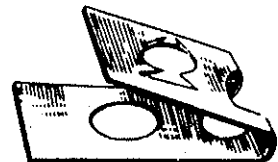

J84 5803

Replaces 10005510
Blue

Nut: Front Bumper
(Impact Strip) & Letters
General Usage GM 1980-Up

UNIT PACKAGE 100

GM WIRING

Clip (Retaining)
Convolved Wiring Harness

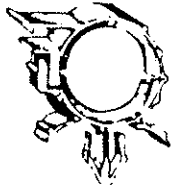

J78 4973

Replaces 8911473
.350 Size

UNIT PACKAGE 25

J78 4975

Replaces 8911472
.500 Size

UNIT PACKAGE 25

J78 4974

Replaces 8911497
.413 Size

UNIT PACKAGE 25

J78 4976

Replaces 8917320
.750 Size

UNIT PACKAGE 25

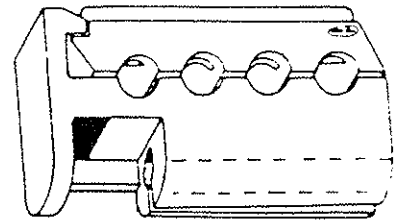

CLOSED

J84 5861

Replaces 62 94103
Retainer Spark Plug
Wires-4 Wire
G.M. Cars & Trucks
UNIT PACKAGE 25

GM RUBBER BUMPER

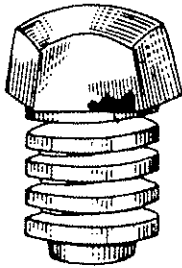

J80 5168

Replaces 1717924
Bumper, Trunk Lid;
General Motors '79/
UNIT PACKAGE 25

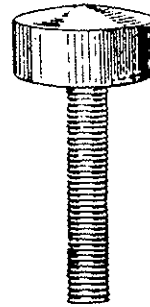

J79 5115

Replaces 371945
8mm Hood Bumper, Metric
G.M. '78/
UNIT PACKAGE 25

GM HEADLINER CLIP

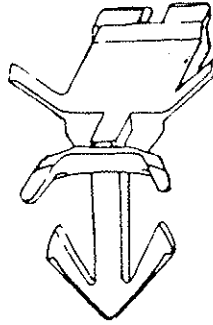

J83 5680

Replaces 20248333
Clip, Headlining Garnish
Moulding
Cadillac
UNIT PACKAGL 25

GM ROD CLIP



J74 4077

Replaces 1247872
Clip, Linkage, Carburetor Etc.:
Oldsmobile and Other
General Motors Products
UNIT PACKAGE 100

GM WELL NUT

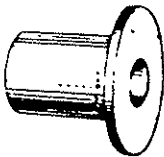

J78 4741

Replaces 375711, 14002811
Well Nut, Luggage Carrier
Support to Panel
Metric Threaded M6.3 x 1.0
Insert Head 20mm Dia x 1.5mm High
Shank 12.5mm Dia. x 15mm Length
G.M. '77/
All Full Size Station Wagons
UNIT PACKAGE 25

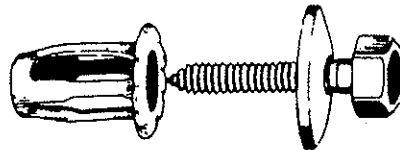

J76 4403

Replaces 367292 & 367291
Nut & Bolt Mounting, Outside Rear View
Mirror:
UNIT PACKAGE 50



J78 4958

Replaces 20130258
6mm
Nut, Washer & Screw Anchor Kit,
For Top Carriers
G.M. Station Wagons '79/
UNIT PACKAGE 25

GM MISC.



J991505

Replaces 20087231
Retainer,
Hood Release Cable
G.M. Various Models '80/.
UNIT PACKAGE 25

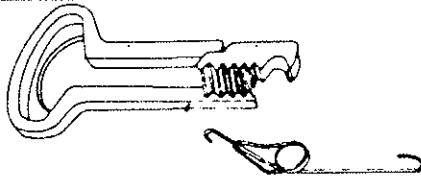

J84 5863

Replaces 7827157, 7804908
Kit, Gear & Preload Spring
Ignition Switch Actuator
G.M. Models 'A', 'B', 'C', 'E', 'F',
'G', & 'X' w/ tilt wheel '82/
Not supplied separately by factory
(Only with 7844651 Kit)
UNIT PACKAGE 1

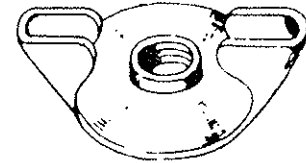

J82 5609

Replaces 14001197
6mm
Air Cleaner Hold Down Wing Nut
Olds, Pontiac, Chevrolet, G.M.C.
Truck
UNIT PACKAGE 25

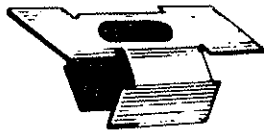

J73 3836

Replaces 1245923
Fastener, Front And Rear
Bumper Protective Plastic Insert.
Buick
UNIT PACKAGE 100



JWC 2049

Door Inside Handle, Door
and Quarter Regulator
Handle Retaining Clip:
Buick, Cadillac, Chevrolet, Oldsmobile,
Pontiac, All Cars, All Models '49/.
Rambler '60-'72 Toyota
UNIT PACKAGE 100



J87 6203

Replaces 2062174
Bracket Rear View Mirror
(Windshield Mount).
General Motors '87/.
UNIT PACKAGE 10



J74 4067

Replaces 612019
7/16" Stud Size
O.D. 27/32"
Push Nut, Bumper Bolts;
Pontiac and Other Car Lines
UNIT PACKAGE 100

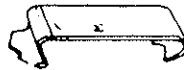

J84 5885

Replaces 5949351
Clip, Rear Lamp & Side Marker
Retaining
G.M. Camaro, Firebird '76/
'J' & 'P' Bodies '82/
UNIT PACKAGE 50

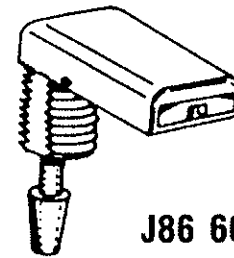

J86 6054

Replaces 25509962
Nozzle Windshield Washer
Plastic
General Motors 'A' Body '82
UNIT PACKAGE 10

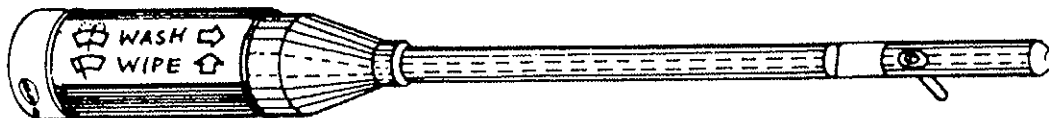

J85 5896

Replaces 14022010
Lever, Directional Signal
Control
G.M. Chevette & T-1000
'T' Bodies '81/
UNIT PACKAGE 1

GM MISC.

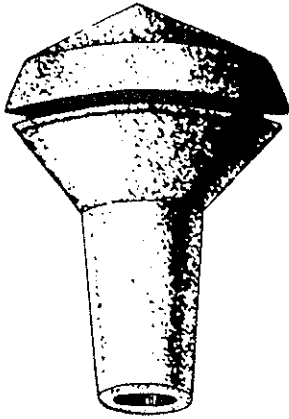

J76 4437

Replaces 3990592
Knob, Gear Shift Lever
General Motors '75/
UNIT PACKAGE 10

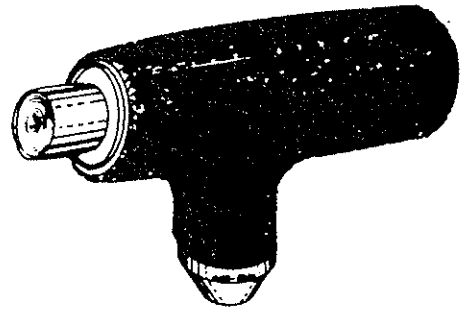

J84 5761

Replaces 14055419
470701
Knob Gear Shift
Chevette T-1000 '76/ ;
Buick Skyhawk '76-'80;
Chev Monza '76-'80;
Olds Starfire '76-'80;
Pont. Sunbird '76-'80
UNIT PACKAGE 1



J76 4396

Replaces 9796223
5/16" x 1"
Hex Head Bolt, Fenders and
Shrouds CA Point:
UNIT PACKAGE 50

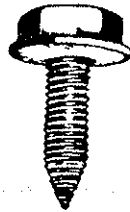

J72 3660

Replaces
3960314 5/16" x 18 x 13/16"
Screw, Radiator Support, Radiator
Fan Shroud, Radiator Grille,
Headlamp:
UNIT PACKAGE 50

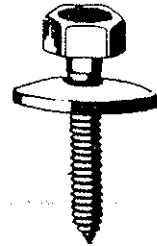

J76 4427

Replaces 367291
Bolt, Outside Mirror Mounting:
UNIT PACKAGE 50



J81 5307

Replaces 9721917
Bushings, Door Hinge:
General Motors:
UNIT PACKAGE 50



J83 5711

Replaces 20429500
Bushings, Door Hinge
G.M. 'A', 'B', 'F', 'J' Bodies
Also S-10 Truck, Pickup, &
Vans '68
UNIT PACKAGE 25



J83 5712

Replaces 20345137
Bushings, Door Hinge
G.M. 'A', 'B', 'F', 'J', Bodies
Also S-10 Truck, Pickup, &
Vans '68
UNIT PACKAGE 25

FORD TRIM CLIP

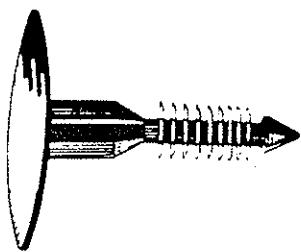

J78 4838

Replaces N-800387-S
Clip, Dashboard Attaching:
Ford Products 79/
UNIT PACKAGE 50

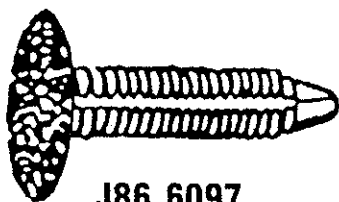

J86 6097

Replaces N-804349-S
Clip, Interior Trim
Black Plastic
Hole Dia. 7.0mm
Grip Range Up To 30.0mm
Head Dia. 25.0mm
Ford
UNIT PACKAGE 25

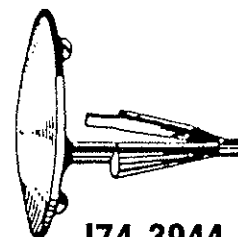

J74 3944

Replaces 385595-S
Hood Insulation Fastener (For
Heavier Type Insulation):
Ford Products
UNIT PACKAGE 100

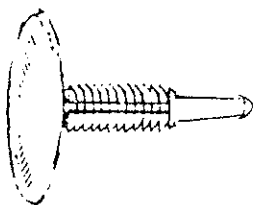

J79 5109

Replaces 388930-A
1/4 in. x 1.22
Pin, Push Type
Ford '80
UNIT PACKAGE 100

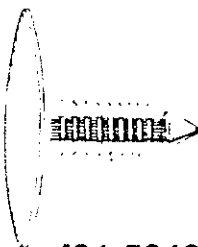

J81 5310

Replaces 388904-S
Clip, Front & Rear Bumpers
Cover to Bar
Ford Products
UNIT PACKAGE 50

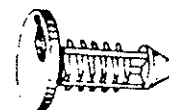

J85 5950

Replaces N80 5170 S
Retainer, 5mm Hole
10mm Head Diameter
Various Layer Attachments
Plastic
Ford Mustang, Capri '84/
UNIT PACKAGE 50

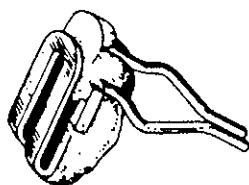

J76 4297

Replaces 383035-S100
Clip, Door Trim Panel,
with Anti-Rattle Wedge:
Ford Products '75/
UNIT PACKAGE 25

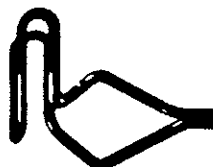

J67 3100

(Replaces Ford
358470
Chrysler 1900654)
Door Trim Panel Clip:
Ford
Products
UNIT PACKAGE 100

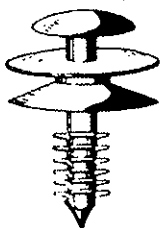

J78 4839

Replaces 388499-S
Clip, Inside Door Panel Attaching:
Ford Products 78-1/2/
UNIT PACKAGE 50

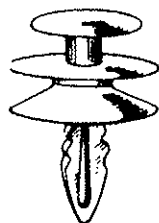

J77 4508

Replaces 387477-S
Clip, Trim Panel
Ford Products '77/
UNIT PACKAGE 100

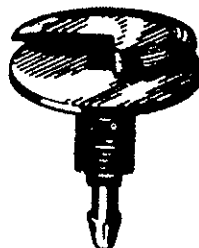

J77 4693

Replaces 387496-S
Trim Panel Clip:
Ford Products '76/
UNIT PACKAGE 25



J77 4694

Replaces 387182-S
Seat Back Panel Retainer
Ford Products '77/
UNIT PACKAGE 25

FORD TRIM SCREW

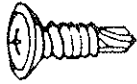

J86 6050

Replaces N802337-S9
Screw Pozidrive Oval Head
Self Drilling M4.2-1.4 x 25mm
Zinc Finish
Ford & General Purpose
UNIT PACKAGE 100



J86 6052

Replaces 388020-S47
Screw Phillips Round Washer
Head, Self Drilling No. 8 x 1/2"
Head Dia. 3/8" Chrome Finish
Ford & General Purpose
UNIT PACKAGE 100



J86 6153

Replaces 384474-S
Screw Phillips Round Washer Head
Self Drilling With Biwax,
Chrome Finish No. 8-18 x 3/8"
Ford Products & General Purpose
UNIT PACKAGE 100

FORD MOULDING

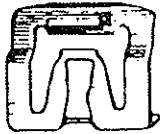

J71 3467

Clip, Windshield
Reveal Moulding:
Ford
Used on Cars with
Aluminum Mouldings to
Avoid Damage to Moulding
UNIT PACKAGE 100

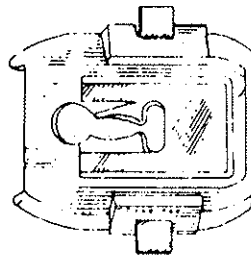

J79 5099

Replaces E0LZ-6620818A
Retainer, Door Outside Moulding
Ford Products '80/
UNIT PACKAGE 50

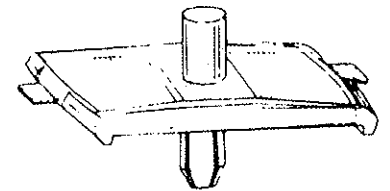

J82 5546

Replaces E2VZ-5410198A
Clip, Rocker Panel Moulding
Ford Products '82/
UNIT PACKAGE 25

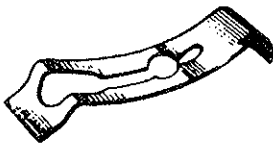

J77 4710

Replaces D70Z-6542487-A
Clip, Lower Reveal Moulding,
Rear Window:
Ford Products '77/
UNIT PACKAGE 100



J78 4817

Replaces N-800503-S
Clip (Plastic), Front Fender:
Ford Products '79/
UNIT PACKAGE 100

FORD HEADLAMP ADJUSTING ASSEMBLY

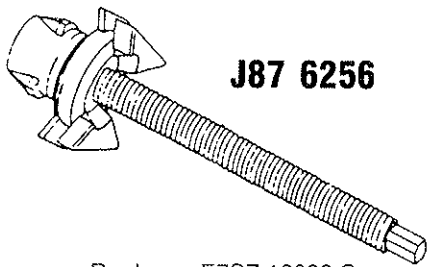

J87 6256

Replaces E7SZ-13032-C
Headlamp Adjusting Assembly
12-28 x 2 1/2" Screw Zinc Finish
Gray Plastic Nut. R.H. Lower
L.H. Upper
Ford T'Bird, Cougar '87
UNIT PACKAGE 5

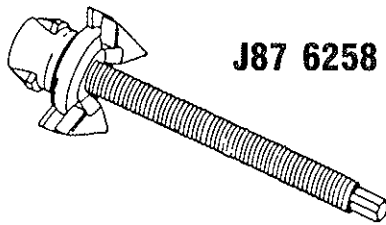

J87 6258

Replaces E7SZ-13032-D
Headlamp Adjusting Assembly
12-28 x 2". Screw Zinc Finish
Gray Plastic Nut. R.H. Upper
L.H. Lower
Ford T'Bird, Cougar '87
UNIT PACKAGE 5

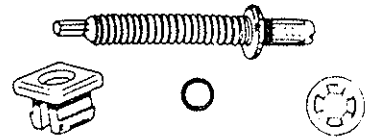

J87 6251

Replaces E6DZ-13032A
Headlamp Adjustin Assembly for
Aerodynamic Headlamp Designs
Screw M6 x 60mm O.A. Length
Ford Taurus, Sable '86
UNIT PACKAGE 10

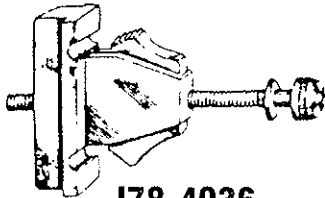

J78 4936

Replaces D8BZ-13032A
Headlamp Adjusting
Screw & Nut Assembly
Ford Fairmont '78/
Full Size Ford & Mercury
Mustang & Pinto '79/
Mercury Zephyr '79/
Bobcat '79/
UNIT PACKAGE 25

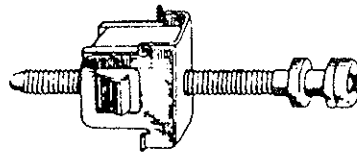

J77 4689

Replaces D7AZ-13032A
Headlamp Adjusting
Screw & Nut Assembly
Ford Light Trucks '76/
UNIT PACKAGE 25

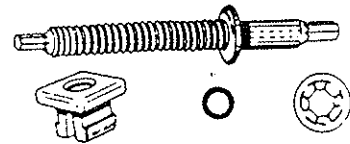

J87 6252

Replaces E6DZ-13032 B C
Headlamp Adjusting Assembly
For Aerodynamic Headlamp Designs
Screw M6 x 74mm O.A. Length
Ford Taurus, Sable '86
UNIT PACKAGE 10

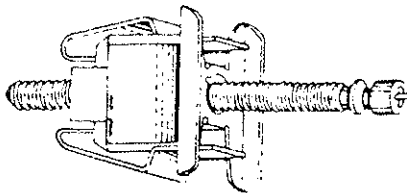

J83 5676

Replaces E3DZ-13032A
Headlight Adjusting
Screw & Nut Assembly
'83 T-Bird & Cougar, Ford LTD
Mercury Marquis
'84 Tempo & Topaz
UNIT PACKAGE 10

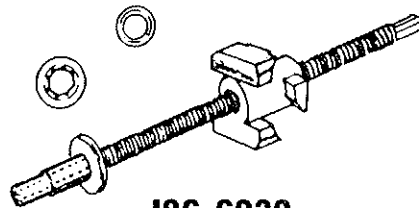

J86 6032

Replaces E6FZ 13032-B
Headlamp Adjusting Screw
and Nut Assembly. w/ 'O'
Ring & Retainer
For Aerodynamic Headlamp
Designs, Horizontal Adjustment
Ford Escort & Lynx '85/
UNIT PACKAGE 5

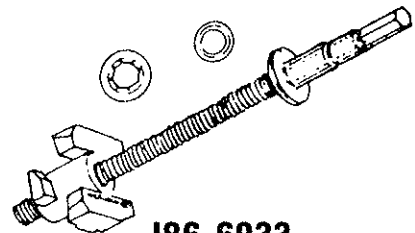

J86 6033

Replaces E6FZ 13032C
Headlamp Adjusting Screw
and Nut Assembly w/ 'O'
Ring and Retainer
For Aerodynamic Headlamp
Designs, Vertical Adjustment
Ford Escort, Lynx '85/
UNIT PACKAGE 5

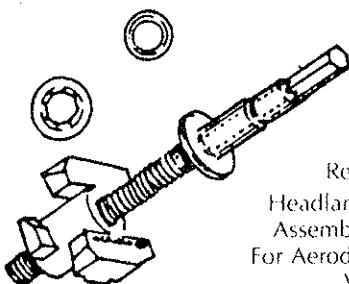

J87 6228

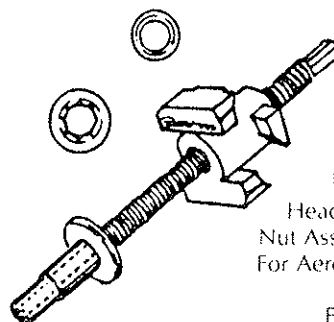

Replaces E63Z-13032A
Headlamp Adjusting Screw & Nut
Assembly w/ 'O' Ring & Retainer.
For Aerodynamic Headlamp Designs.
Vertical Adjustment
Ford Tempo; Topaz '86/
UNIT PACKAGE 10





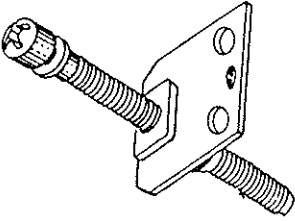

J87 6229

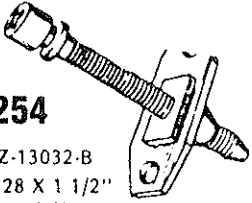
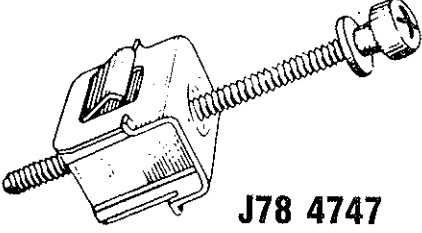
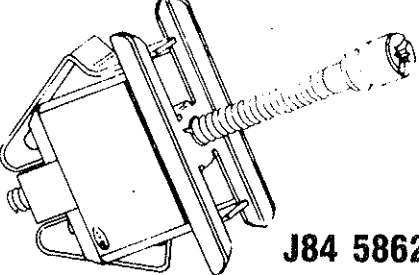
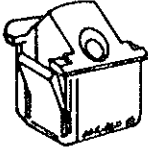
Replaces E63Z-13032B
Headlamp Adjusting Screw and
Nut Assembly w/ 'O' Ring & Retainer.
For Aerodynamic Headlamp Designs.
Horizontal Adjustment
Ford Tempo, Topaz '86/
UNIT PACKAGE 10

FORD HEADLAMP ADJUSTING ASSEMBLY

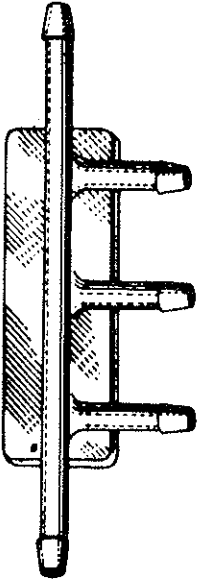
 <p>J71 3465 Replaces D0DZ-13032A Headlight Adjusting Screw & Nut Ford Products '69/ UNIT PACKAGE 25</p>	 <p>J74 4079 Replaces D4OZ-138160B Bearing, Headlamp Adjusting Ring Ford UNIT PACKAGE 100</p>	 <p>J76 4254 Replaces D1TZ-13032-B Screw Size 1/4 - 28 X 1 1/2" Headlamp Screw & Nut Assembly Ford Truck F-100 '75/ Ford Truck F-100-35 '70/ Full Size Ford '69, Mustang '70 T-Bird '66, Torino '72/ General Usage on Ford Products UNIT PACKAGE 25</p>
 <p>J78 4747 Replaces D8TZ-13032A Headlamp Adjusting Screw and Nut Assembly Ford Trucks '78/ UNIT PACKAGE 25</p>	 <p>J84 5862 Replaces E43Z 13032A Headlamp Adjusting Screw & Nut Assembly w/ Slotted Torx Screw Ford Products '84/ UNIT PACKAGE 10</p>	 <p>J86 6071 Replaces N 803822-S Clip, Headlamp Door Retaining For M4.2 Screw, Plastic. Ford Aerostar '86/ UNIT PACKAGE 25</p>

FORD VACUUM TEE

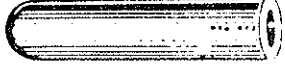
 <p>J75 4210 Replaces 384111-S Tee, 5 Way Vacuum Connector: Ford Products '75/ UNIT PACKAGE 25</p>	 <p>J74 4046 Replaces 380613S Tube Size 1/4" Plug, Unused Manifold Outlets: Also Emission Controls: Ford Products UNIT PACKAGE 25</p>	 <p>J74 4047 Replaces 380614S Tube Size 3/16" Plug, Unused Manifold Outlets: Also Emission Controls: Ford Products UNIT PACKAGE 25</p>
 <p>J75 4163 Replaces C9AZ-9C492A Tube Size 3/8" I.D. Cap-Vacuum Manifold Outlet for 3/8" I.D. Tube Heat Resistant Rubber. Ford Products. UNIT PACKAGE 25</p>	 <p>J75 4164 Replaces C9AZ-9C492B Tube Size 5/16" I.D. Cap-Vacuum Manifold Outlet for 5/16" I.D. Tube Heat Resistant Rubber. Ford Products. UNIT PACKAGE 25</p> <p>J75 4165 Replaces C9AZ-9C492C 1/4" I.D. Tube Size Cap-Vacuum Manifold Outlet for 1/4" I.D. Tube Heat Resistant Rubber. Ford Products. UNIT PACKAGE 25</p>	

FORD PIGTAIL

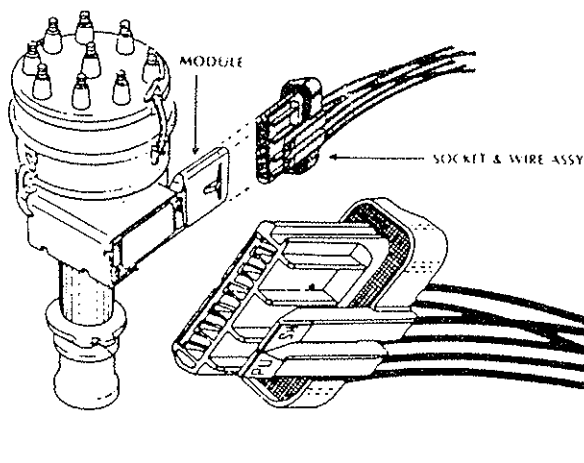

J87 6259

Replaces E5ZZ-12A209A
 Socket & Wire Assembly
 Electronic Module E.E.C. IV Ignition
 6 Leads, 8" Length;
 14 Gauge Wire -GXL Insulated;
 Ford '83
 UNIT PACKAGE 1

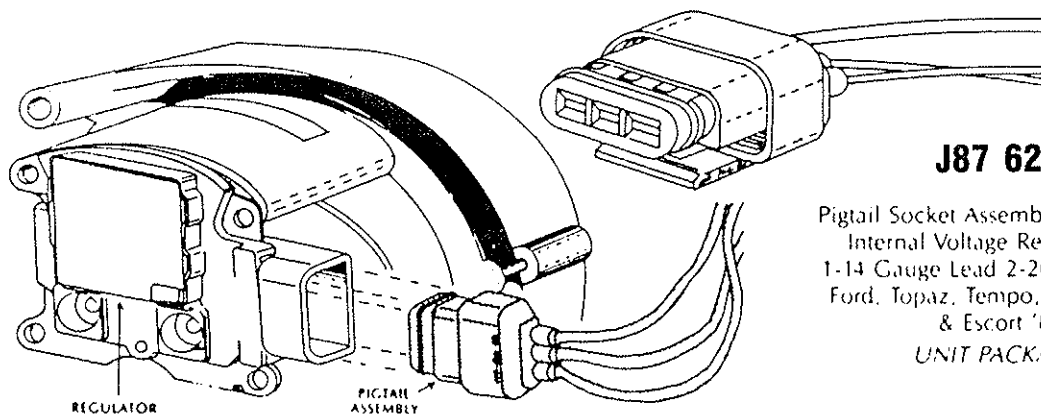

J87 6249

Pigtail Socket Assembly w/10" Leads
 Internal Voltage Regulator Plug
 1-14 Gauge Lead 2-20 Gauge Leads
 Ford, Topaz, Tempo, Sable, Taurus
 & Escort '86/
 UNIT PACKAGE 6

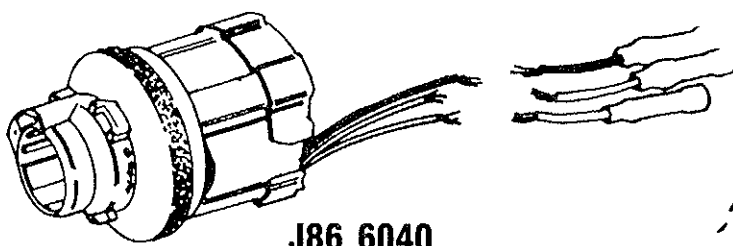

J86 6040

Replaces E1AZ 13410-A
 Socket & Wire Assembly, 8" Leads w/Connectors.
 Rearlamp Ford, LTD, T-Bird; Mercury Marquis,
 Cougar '81/'82/; EXP, LN7 '82/'83/; Ford, Mercury
 Station Wagon '83/, Escort, Lynx, Station Wagon '81/;
 Fairmont, Zephyr '81/'83.
 Parking Lamp, Lincoln '81/. Fairmont, Zephyr '81/'83/
 UNIT PACKAGE 6

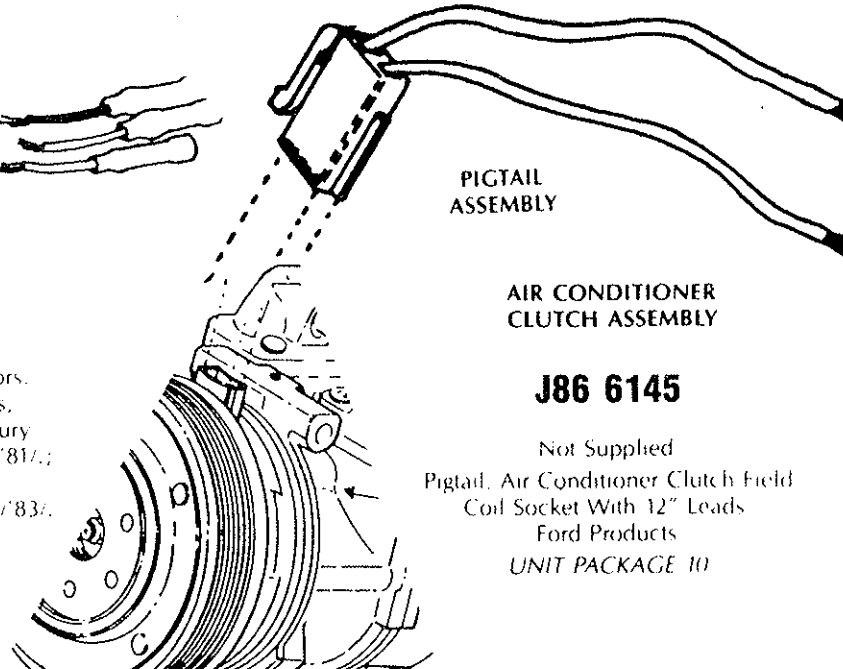

PIGTAIL
 ASSEMBLY

AIR CONDITIONER
 CLUTCH ASSEMBLY

J86 6145

Not Supplied
 Pigtail, Air Conditioner Clutch Field
 Coil Socket With 12" Leads
 Ford Products
 UNIT PACKAGE 10

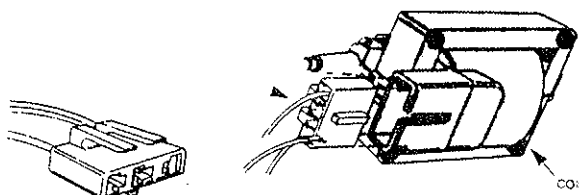

PIGTAIL IGNITION COIL J991463

Pigtail, Ignition Coil
 W/3 Color Coded Wires, 10" Long 2-18 Gauge
 1-16 Gauge. Fits Coil E73Z-12029A
 Ford, Various Models '86/
 UNIT PACKAGE 6

FORD PIGTAIL

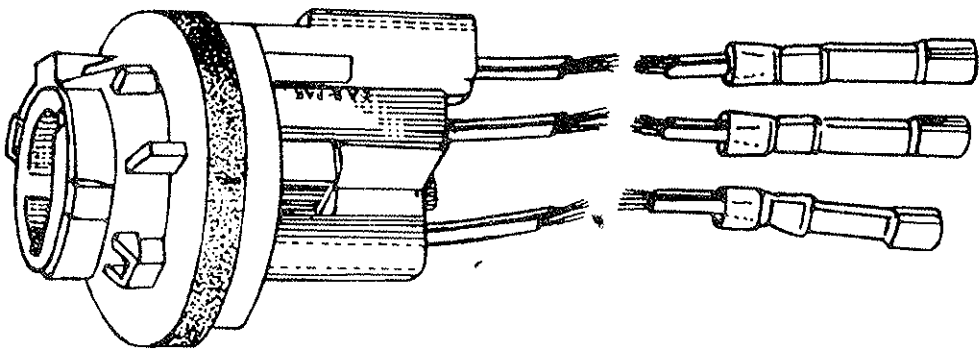

J78 4947
 Replaces D3AZ-13410-G
 Pigtail, Stop and Tail Light
 Ford Products '73/.
 UNIT PACKAGE 6

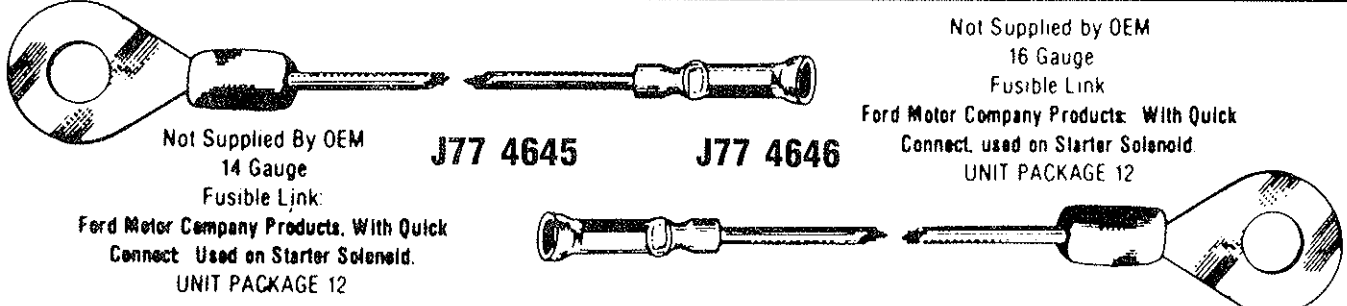

J77 4645
 Not Supplied By OEM
 14 Gauge
 Fusible Link:
 Ford Motor Company Products. With Quick
 Connect Used on Starter Solenoid.
 UNIT PACKAGE 12

J77 4646
 Not Supplied by OEM
 16 Gauge
 Fusible Link
 Ford Motor Company Products. With Quick
 Connect. used on Starter Solenoid.
 UNIT PACKAGE 12

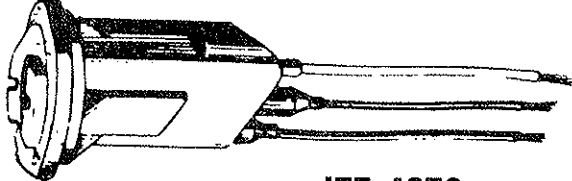

J77 4672
 Replaces D3AZ-13410B
 Tail Light, Station Wagon
 Ford '73-'76:
 UNIT PACKAGE 6

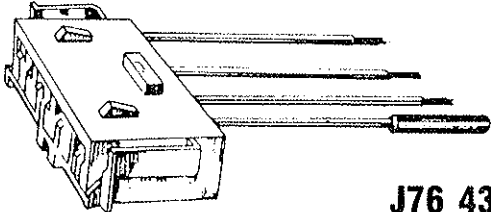

J76 4342
 Not Supplied by OEM
 Voltage Regulator Pigtail
 Ford Products '75/
 UNIT PACKAGE 10

FORD BODY BOLT



J78 4857

Replaces 57130-S2
1/4-20 x 7/8"
Bolt, Hex Head Dog Point, With Attached
1" Free Spinning Washer.
Ford Products '79/.
UNIT PACKAGE 50



J78 4858

Replaces N-606675-S2
6mm x 1 x 18mm
Bolt, Hex Head, Dog Point, with attached
19mm, Free Spinning Washer.
Ford Products '79/.
UNIT PACKAGE 50



J78 4859

Replaces N-606675-S36
6mm x 1 x 18mm
Bolt, Hex Head, Dog Point, with attached
19mm Free Spinning Washer.
Ford Products '79/.
UNIT PACKAGE 50



Style Only

J77 4459

Replaces 57030-S2
Black Phosphate
1/4 - 20 x 15/16 in.
Hex Head Bolt, Dog Point with
3/4 in. Washer
Ford Products '77/
UNIT PACKAGE 50

J77 4465

Replaces 57048-S2
Phosphate and Oil
3/8 - 16 x 1 3/16 in.
Hex Head Bolt, Dog Point with
1 in. Washer, Fenders & Shrouds
Ford Products '77/
UNIT PACKAGE 50

J77 4471

Replaces 384932-S36
Dichromate
5/16 - 18 x 1 3/16 in.
Hex Head Bolt, Dog Point with
7/8 in. Washer, Fenders & Shrouds
Ford Products '77/
UNIT PACKAGE 50



J78 4860

Replaces N-606676-S36
6mm x 1 x 23mm
Bolt, Hex Head, Dog Point, With attached
19mm, Free Spinning Washer.
Ford Products '79/.
UNIT PACKAGE 50

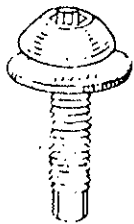

J81 5291

Replaces N800928-S45
6mm x 1 x 21mm
Screw, Torx Pan Head w/ Attached
16mm Diameter Washer
Chrome Plated, Truck Mirror
Mounting Bracket
Ford Trucks '80/
UNIT PACKAGE 25

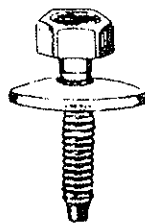

J81 5326







Replaces N-606676-S2
6MM-1 x 23MM
Black
Bolt, Hex Head, Dog Point with
attached 19MM Free Spinning
Washer.
Ford Products
UNIT PACKAGE 50



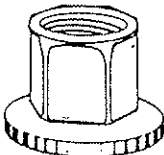

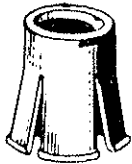
J77 4461

Replaces 57032-S36
Dichromate
1/4-20 x 1 1/8"
Hex Head Bolt, Dog Point, With 3/4"
Washer, Fenders and Shrouds:
Ford Products '77/.
UNIT PACKAGE 50

FORD NUT

 <p>J78 4845 Replaces N-621906-S2 - 6mm Nut, with size 18mm Black Free Spinning Washer: Ford Products 79/. UNIT PACKAGE 50</p>	 <p>J85 5914 Replaces N621945S2 Nut w/ Free Spinning Washer M12 - 1.75 w/ 27mm Washer Ford Bumper Bolt Nut and General Purpose UNIT PACKAGE 10</p>	 <p>J80 5179 Ford D7VZ-6050074A Nut, Plastic, Barrel Type, For Tee Type Moulding Clips: Ford, General Motors, etc. UNIT PACKAGE 100</p>	 <p>J77 4717 6mm Nut Size Nut, Rear License Plates: Ford Fiesta 78/. UNIT PACKAGE 50</p>
 <p>J65 1090 Front & Rear License Plate Nut, Nylon: Ford, Mercury General Purpose UNIT PACKAGE 100</p>	 <p>J67 3120 Side Mirror Nut: Ford & Mercury Headlamp Door Attaching Nut: Ford, Comet, Mercury UNIT PACKAGE 100</p>	 <p>J77 4474 Replaces 380707-S Hole Size 1/4" Nut License Plates Ford Motor Products UNIT PACKAGE 100</p>	

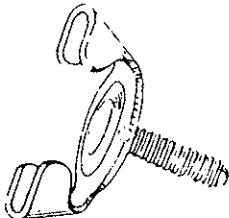
FORD WING NUT

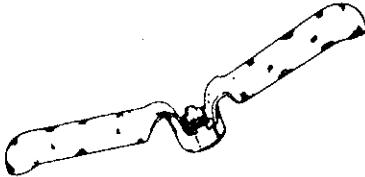
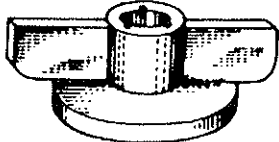
 <p>J80 5211 Replaces 383132-S9, 382461-S9 1/4 - 20 Thumb Screw, Air Cleaner Ford Products UNIT PACKAGE 25</p>	 <p>J84 5783 Replaces N801368 S36B Wing Nut, Air Cleaner Hold Down Ford Escort, Lynx M6 x 1.0 25mm Washer Face UNIT PACKAGE 25</p>
 <p>J72 3675 Replaces B9AZ-1462A 3/8-16 Thread Size Spare Tire Hold Down Nut UNIT PACKAGE 25</p>	 <p>J76 4253 3/4" Hole Size Nut, Nylon, Air Cleaner Hold Down: Ford Products. UNIT PACKAGE 100</p>

FORD U-NUT



J77 4733

Replaces #8 Screw Size
Nut, U-Type:
Ford Products and General Purpose.
UNIT PACKAGE 50

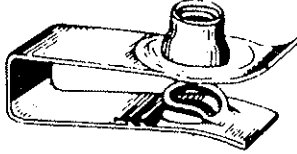

J77 4679

1/4-20
Panel Range 210-330
Nut, Extruded Type. For Installation of
Grilles in Fibreglas Sections
Ford Trucks and Vans
UNIT PACKAGE 50



J76 4387

Replaces 45269-S
3/8-16 Range (050-200)
Nut, Impact Bumper and General
Purpose
Ford Products '69/
UNIT PACKAGE 25



J74 4056

Replaces 385417-S
1/8" Stud Size for 1/4" Hole
Tubular Nut, (Black Plastic)
Retains Name Plates & Emblems:
Mustang, Pinto, Montego,
Lincoln, Mark IV, Etc.
UNIT PACKAGE 100

FORD WINDOW

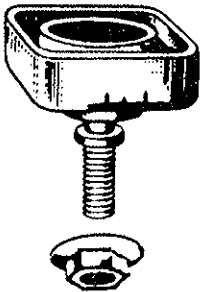

J76 4296

Replaces D6AZ-5323240-A
Roller & Nut, Window Guides:
Ford Products '74-'76.
UNIT PACKAGE 10

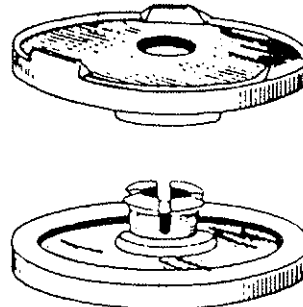

J73 3792

Door Glass To Channel
Attaching Fastener:
Ford Products
UNIT PACKAGE 10

FORD METAL CLIP



J71 3475

Replaces C5Z217531A
Windshield Wiper Clip

Headlamp Flipper Cover Clip
Thunderbird
Torino
UNIT PACKAGE 50



J72 3568

Replaces 383212 S-2
Clip, Transmission
Ford Products
UNIT PACKAGE 50

FORD RIVET

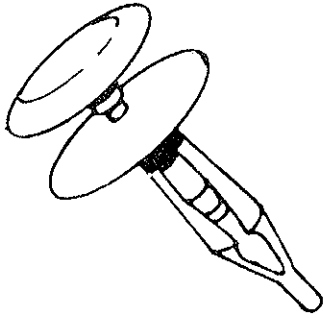

J87 6193

Replaces N-803825-S
N-803196-S
Drive Rivet
Black Plastic
M6 (3/16") Hole
Panel Range 5.0-12.0mm
Head Dia. 24mm
Various Trim Attachments
Ford Products '84
UNIT PACKAGE 25



J85 5944

Replaces 20570245 N803934-S,
N804614-S
Rivet (Black Plastic) Push Type
Hole Size 8mm
Panel Range 5 - 10mm
Washer Face 25mm
Ford, Taurus, Sable, Bumper Fascia '86
G.M. Fiero, Tire Compartment '84
UNIT PACKAGE 25

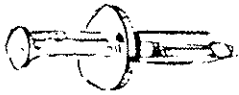

J85 5945

Replaces N8037095
Rivet (Black Plastic) Push Type
Hole Size 6.3mm
Panel Range 5-10mm
Washer Face 15mm
Various Fascia Attachments
Ford '86
UNIT PACKAGE 50

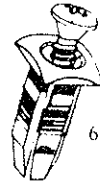

6mm sq hole

J85 5948

Replaces N803494-S
Rivet (Screw Type) (Black Plastic)
Various Fascia & Grill Attachment
Ford Aero Star '85/
Light Truck, Escort, Lynx '86/
UNIT PACKAGE 50

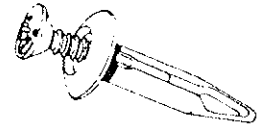

J85 5949

Replaces N803946-S
Rivet (Black Plastic) Screw Type
Hole Size 6.3mm
Panel Range 5 - 12mm
Washer Face 15mm
Various External Components
Ford '86/
UNIT PACKAGE 25

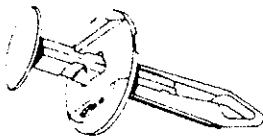

J85 5951

Replaces N803716-S
Rivet (Black Plastic) Push Type
Hole Size 6mm
Panel Range 5 - 9mm
Washer Face 18mm
Various Fascia Attachment
Ford Mustang '85/
UNIT PACKAGE 50

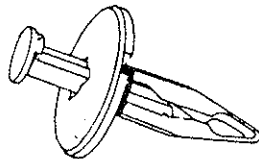

J86 6095

Replaces N-804674-S
Rivet (Drive Style) (Black Plastic)
Hole Dia. 7.0mm
Grip Range 12.0mm-15.0mm
Washer Face 25.0mm
Ford Mustang, Capri
UNIT PACKAGE 50

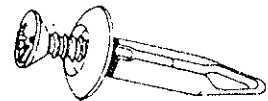

J86 6096

Replaces N-804570-S
20664091
Rivet (Screw Type) (Black Plastic)
Hole Dia. 6.3mm
Grip Range 2.5mm-8.0mm
Washer Face Dia. 18.0mm
Various Interior Trim Applications
Ford, Lincoln, Mercury &
G.M., Fiero
UNIT PACKAGE 25

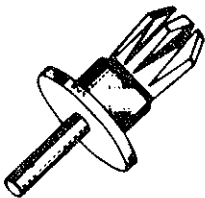

J78 4790

Replaces 387944-S
Rivet (Plastic), Grille Retaining
Ford Trucks and Vans '78/
UNIT PACKAGE 50

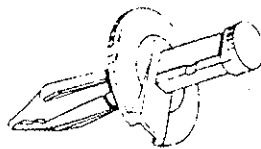

J83 5636

Replaces 802781-S
Black Plastic
Drive Rivet, General Usage
Ford '83/, G.M. 'P' Car '84/
UNIT PACKAGE 25

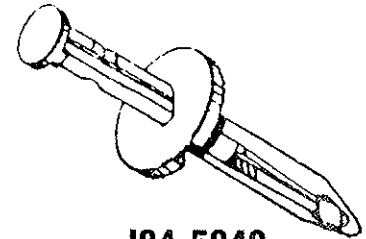

J84 5840

Replaces N803362-S, 20510029
Drive Rivet (Black Plastic)
Escort Lynx, Luggage
Compartment '84/, Pontiac Fiero
'P' Car, Front Trunk Compartment
'85/
UNIT PACKAGE 50

FORD RIVET

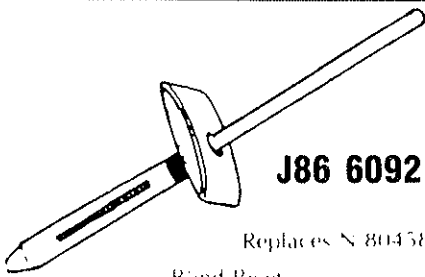

J86 6092

Replaces N 804583

Blind Rivet
Super Tough Nylon Black
Rectangular Head 8.0mm x 15.0mm
Rivet Dia. 3.96mm
Grip Range 6.0 to 5mm
Gas Vent Grille Retaining
Ford Aerostar '86
UNIT PACKAGE 25

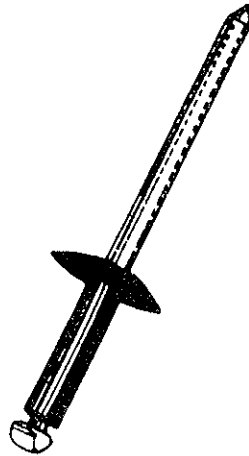

J80 5229

Replaces 388664-5100
Rivet, Grille Retaining:
Mustang '79/.
UNIT PACKAGE 25

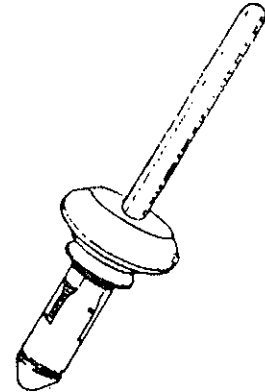

J86 6094

Replaces Ford N803739-S
Black Plastic Rivet
1/4" Dia. 6.3 Hole Dia
11/16 Head Dia
UNIT PACKAGE 25



J68 3239

Front License Plate Retainer
Fiesta '78/ Grille Fastener Mustang.
Fairlane. Other Ford Products '69/.
UNIT PACKAGE 100

FORD MISC.



J9505

Ford & Universal
(C7AB-12A163C)
Loom Clip for 1/4 Hole(plastic)
UNIT PACKAGE 25



J9510

Ford & Universal
Brake Adjusting Hole Cover
UNIT PACKAGE 25

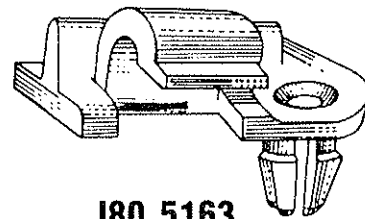

J80 5163

Replaces D5ZZ-16826A
Clip, Hood Support Prop:
Mustang '75/.
UNIT PACKAGE 25

CHRYSLER TRIM



J77 4695

Replaces 6003423
Interior Trim Panel Retainer.
Chrysler Products 77/.
UNIT PACKAGE 50

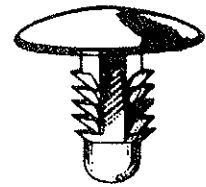

J80 5149

Replaces 6031299 - Gray
Clip, Bumper Strip Retaining.
Chrysler Products 79/.
UNIT PACKAGE 50



J83 5618

Replaces 7703-077-066, 6501227
Clip, Rear Window Moulding
AMC-Renault Alliance '83
Chrysler '85/. Door Panel
UNIT PACKAGE 25

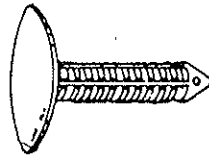

J86 6143

Replaces 4006529 (AMC)
5208743 (Chrysler)
Clip, Trim Panel.
Head Dia. 3/4". Hole Dia. 3/16", Length 1 1/16"
Black Plastic.
Chrysler, AMC
UNIT PACKAGE 50



J78 4820

Replaces 6003654
Clip, (Plastic) Door Trim also front
and Rear Bumper.
Chrysler Products 78/.
UNIT PACKAGE 100

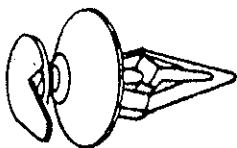

J86 6098

Replaces 8934-202-428
Clip, Interior Door Trim
Plastic
Encore, Alliance '86/
UNIT PACKAGE 50

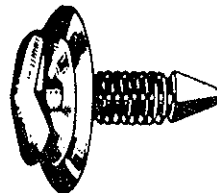

J71 3524

Replaces 6003349
Door Trim Panel
Fastener, Nylon
(Used on Cardboard Panels):
72/. Chrysler Products,
Vallant, Dart, Duster, Demon,
Cadillac 77/
UNIT PACKAGE 100

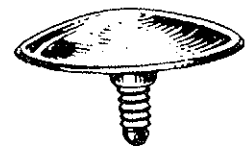

J69 3326

Replaces 2998430
Upper Grille Attachment
For Plastic Grille
Valiant, Dart, Belvidere,
Coronet
UNIT PACKAGE 25



J67 3100

Chrysler 1900654)
Door Trim Panel Clip:
Chrysler Products
UNIT PACKAGE 100

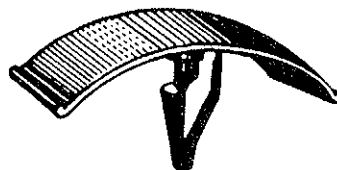

J74 3945

Replaces 385330-S 6003351
Hood Insulation Fastener:
Ford and Chrysler Products
UNIT PACKAGE 100

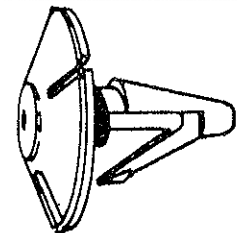

J86 6015

Replaces 4341060
Retainer Hood Insulation,
Plastic.
Chrysler '85/.
UNIT PACKAGE 50

CHRYSLER HEADLIGHT ADJUSTING SCREW

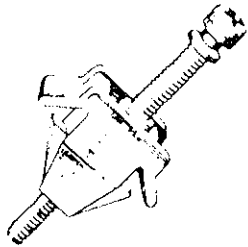

J77 4681

Replaces 3868985
Black
Screw Size 12 - 28 x 1 1/2"
Headlight Adjusting
Nut & Screw Assembly
Chrysler Products
Diplomat & Le Baron '78/
'K' Bodies
UNIT PACKAGE 50

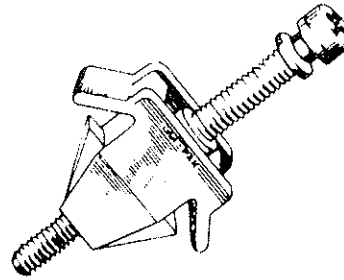

J78 4739

Replaces 3868551
Headlight Screw and Nut Assembly
Chrysler Le Baron and Dodge Diplomat '77.
UNIT PACKAGE 25

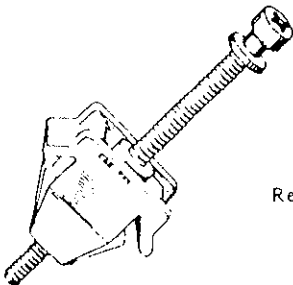

J77 4682

Replaces 5201269, 5201359
Green
Headlight Adjusting
Screw & Nut Assembly
Screw Size 12 - 28 x 2 1/8"
Chrysler Products '78/
UNIT PACKAGE 50

J84 5814

Replaces 4334139
4334142
Headlight Adjusting Screw
and Nut Assembly. Slotted
Torx Recess Screw
White Nut
Chrysler '78/
UNIT PACKAGE 25

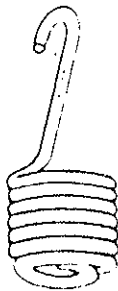
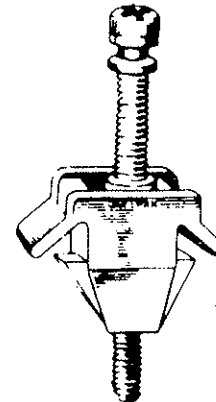

J78 4772

Replaces 3868549
Spring, Headlight Tension
Plymouth Fury
Dodge Compacts '78/
UNIT PACKAGE 25

J84 5874

Replaces 4334140
Headlamp Adjusting Screw & Nut
Assembly
12 - 28 x 2 1/8 in. Slotted Torx
Screw
Chrysler '78/
UNIT PACKAGE 10

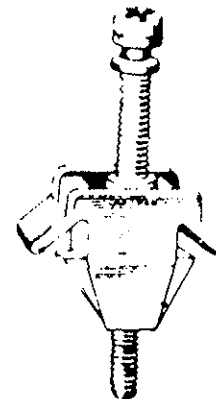

CHRYSLER MOULDING

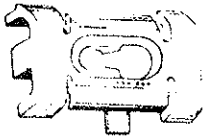

J81 5408

Replaces 6003801
Clip, Quarter, Outside Belt Moulding:
Chrysler Products '82/
UNIT PACKAGE 50



J82 5497

Replaces 6003819
Clip, Roof Transverse Moulding:
Chrysler Products
UNIT PACKAGE 25

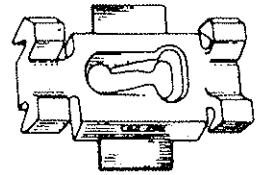

J81 5404

Replaces 6003809
Clip, Roof Outside Transverse
Moulding:
Chrysler Products '82/
UNIT PACKAGE 25

CHRYSLER NUT



J78 4767

Replaces 6031138
Grommet, Headlights:
Chrysler Products
UNIT PACKAGE 100

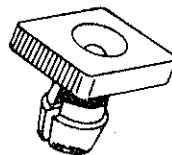

(PLASTIC)

J84 5800

Replaces 6500725
Nut, Headlamp Bezel
Black Nylon No. 10 Screw
Chrysler 'E' Class:
La Baron, New Yorker,
Dodge 400-600 '83/
UNIT PACKAGE 100

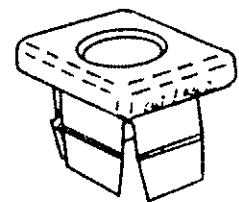

J86 6156

Grommet Nut,
M8 Screw, 10mm Sq. Hole, 6mm Panel
Plastic
Bumper Guard Retaining
Chrysler
UNIT PACKAGE 25

CHRYSLER RIVET

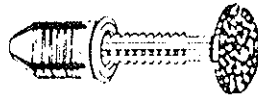

J83 5667

Replaces 4248294
Silver Plastic
Drive Rivet, Interior Trim
Chrysler Passenger Cars & Vans
'83
UNIT PACKAGE 25

J83 5669

Replaces 4248294
Red Plastic
Drive Rivet, Interior Trim
Chrysler Passenger Cars & Vans
'83
UNIT PACKAGE 25

J83 5673

Replaces 4248294
Light Beige Plastic
Drive Rivet, Interior Trim
Chrysler Passenger Cars & Vans
'83
UNIT PACKAGE 25

CHRYSLER MISC.



J68 3236

Windshield and Rear Window
Reveal Moulding Clip
Attaching Screw
Chrysler Products
UNIT PACKAGE 100

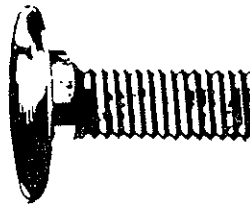

J86 6155

Bumper Bolt
Stainless Steel Cap
M8 x 1.25 x 28mm
Chrysler Style
UNIT PACKAGE 25

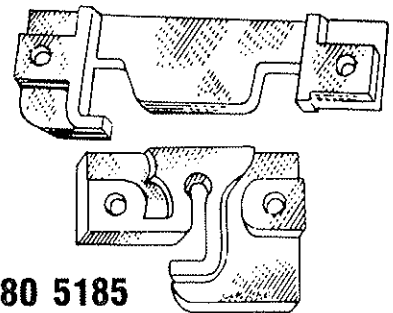

J80 5185

Not Available from
OEM Plastic
Repair Kit, Front Door
Window Guide.
Chrysler Omni and Horizon 78/.
UNIT PACKAGE 12

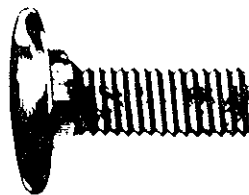

J84 5791

Replaces 6500381
Bumper Bolt, Uncapped
8m x 1.25 x 28mm
Head Diameter 24mm
Front & Rear Bumpers
Omni-Horizon '79/
UNIT PACKAGE 25

HONDA



J82 5555

Replaces 90671-SA5A-0030
Nut, Front Bumper License
Place Attaching:
Honda
UNIT PACKAGE 50

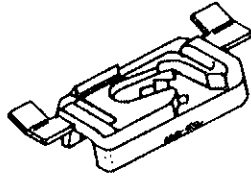

(PLASTIC)

J84 5777

Replaces 90694-SBO-0030
Windshield Moulding Clip
Honda Prelude '83/
UNIT PACKAGE 25

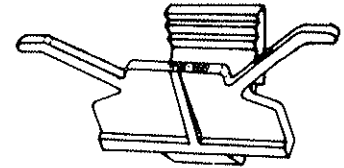

J84 5804

Replaces 90673-SC6-003
Clip, Windshield Moulding
White Plastic
Honda Accord '84/
UNIT PACKAGE 25

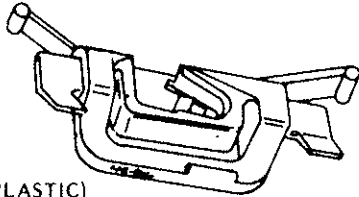

(PLASTIC)

J84 5809

Replaces 90674-SC6-003
Clip, Back Glass Moulding
Honda Accord '84/
UNIT PACKAGE 25



J84 5835

Replaces 74807-SBO-004
Clip, Windshield Moulding
Rear
Black Plastic
Honda '83/
UNIT PACKAGE 25

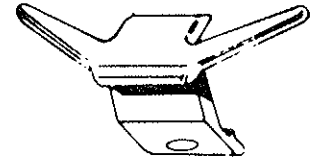

J84 5836

Replaces 90655-SBO-004
Clip, Windshield Moulding
Dark Grey Plastic
Honda '83/
UNIT PACKAGE 25

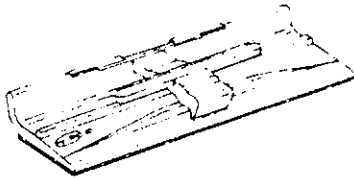

J85 5960

Replaces 90682-SC6-003
Clip, Windshield Moulding
Self Adhesive
Black Plastic, Overall Length 48mm
Honda Accord '84/
UNIT PACKAGE 10

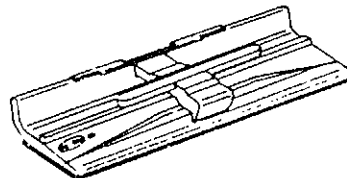

J85 5978

Replaces 90683-SC6-003
Clip, Windshield Moulding
(Plastic) Dark Gray
Overall Length 60mm
Honda Accord '85/
UNIT PACKAGE 10



J84 5837

Replaces 90664-SBO-004
Clip, Windshield Moulding
Black Plastic
Honda '83/
UNIT PACKAGE 25

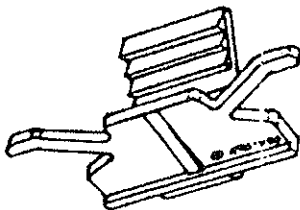

J85 6007

Replaces 90672 SA6 003
90672 SC6 003
Clip, Windshield Moulding
Black Plastic
Honda Accord '84/
UNIT PACKAGE 25

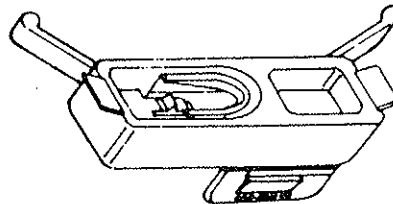

J86 6035

Replaces 73265 SE3 003
Clip, Rear Window Moulding Upper
Plastic
Honda Accord 4-Door '86/
UNIT PACKAGE 25

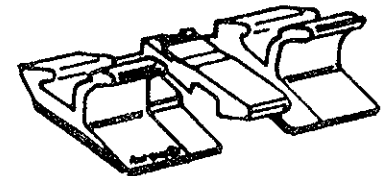

J86 6039

Replaces 90658-SBO-003
Clip, Reveal Moulding Quarter
Window, Self Adhesive Plastic,
Honda Prelude '83/
UNIT PACKAGE 10

NISSAN / DATSUN

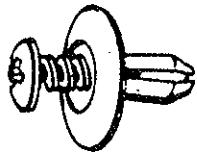

J85 5981

Replaces 80915-29A66
8942-431-900, 9926-50-635
Rivet. Screw Type Hole 6mm
Panel Range 2-5mm
Washer Face 20mm
Plastic
Nissan, Isuzu, Mazda
Various Applications
UNIT PACKAGE 25

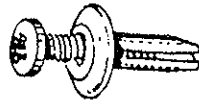

J85 5991

Replaces 90684-SA5-003
10998-30880, 894-298-1190
Rivet. Screw Type
Hole Size M5
Grip Range 2.0 - 6.0mm
Washer Head 15mm
Plastic
Honda Accord: Headlamp Housing
to Grille: '84/, Nissan: Isuzu
Various Applications
UNIT PACKAGE 25

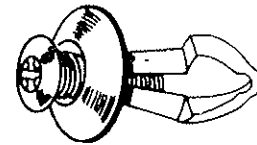

J83 5741

Replaces 66860 01W01
Rivet-Cowel Panel to
Reinforcement Plate
Datsun Truck '80 - up
UNIT PACKAGE 25



J82 5534

Replaces 96706-P0105
Nut. General Purpose
Datsun
UNIT PACKAGE 50

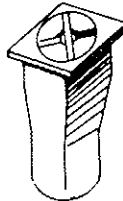

J82 5573

Replaces 01281-00081
Screw Anchor, Plastic
Datsun
UNIT PACKAGE 25

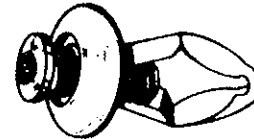

J83 5742

Replaces 63844 01A00
Rivet. Inner Fender Shield
Datsun
UNIT PACKAGE 25

J81 5420

Replaces 96706-H2500
Nut. Anchor Type. (Plastic):
Datsun
UNIT PACKAGE 25

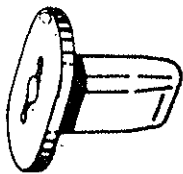

J991325

Replaces 79827-R3000
Grommet Nut. Plastic
M4.2 Screw. 6.8 x 10.8MM Hole
License Plate
Nissan Truck '87/.
UNIT PACKAGE 25

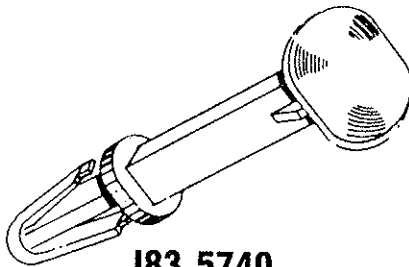

J83 5740

Replaces 62089 N8520
Retainer. Bumper Cover to
Bumper
Datsun '80-Up
UNIT PACKAGE 25

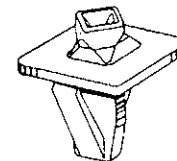

J83 5730

Replaces 62318 U7400
Retainer Grill
Datsun
UNIT PACKAGE 50

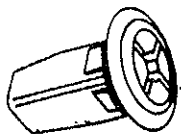

J991324

Replaces 01281-00023
Grommet Nut. Plastic
M4.2 Screw: 8.5MM Sq. Hole;
18MM Dia. Hd.
Nissan Various Applications '86/.
UNIT PACKAGE 25



J81 5386

Replaces 70006-T3000
Clip. Trim Panels:
Datsun
UNIT PACKAGE 25

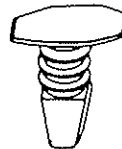

J82 5506



Replaces
8083265000
8083365000
Clip. Weatherstrip:
Datsun
UNIT PACKAGE 50



J83 5688

Replaces 76913-N9900
Black
Clip. General Usage
Datsun
UNIT PACKAGE 50

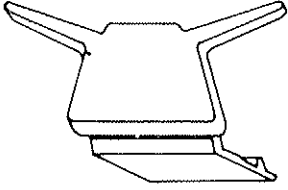
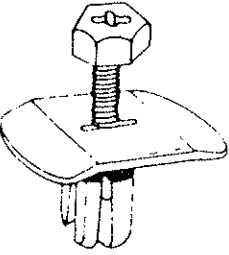
NISSAN / DATSUN

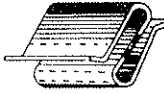
 <p>J84 5767</p> <p>Replaces 72726-D0100 Windshield reveal Moulding Clip Datsun Stanza 1981 - Up UNIT PACKAGE 25</p>	 <p>J85 5930</p> <p>Replaces 63844 D 0100 894221500 Clip with Screw. Hole Size 8mm Nissan & Isuzu. Various Front End Applications UNIT PACKAGE 25</p>	 <p>J86 6017</p> <p>Screw Phillips Washer Head. Type "B" M5 x 9mm w/15mm Dia Washer Head. Black Finish. Rubber Bumper Strip Bracket Nissan UNIT PACKAGE 100</p>
		 <p>J82 5562</p> <p>Replaces 63812-U7400 Plastic Clip, Fender Attaching: Datsun UNIT PACKAGE 25</p>

HYUNDAI

HYUNDAI TRIM CLIPS
Used On Various Interior Applications
100 Per Box

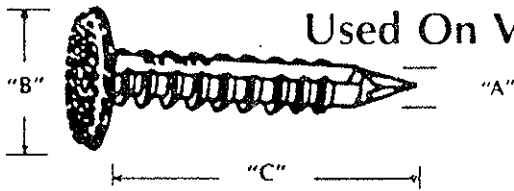

No.	Repl. Hyundai No.	Hole Dia. "A"	hd. Dia. "B"	Length "C"	Color
J87 6219	14943-05210 DL	M5	13.0mm	21.0mm	Regatta Blue
J87 6220	14943-05210 BL	M5	13.0mm	21.0mm	Sand Beige
J87 6221	14943-05210 AM	M5	13.0mm	21.0mm	Smoke Gray
J87 6222	14943-05300 DL	M5	13.0mm	30.0mm	Regatta Blue
J87 6223	14943-05300 BL	M5	13.0mm	30.0mm	Sand Beige
J87 6224	14943-05300 AM	M5	13.0mm	30.0mm	Smoke Gray

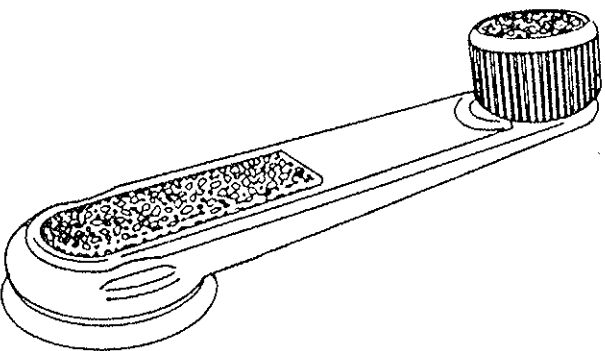

Window Regulator Handle
EXCEL

<p>J86 6137</p> <p>Replaces 826 30-21000BL Sand Beige Unit Package 1</p>	<p>J86 6138</p> <p>Replaces 826 30-21000DL Regatta Blue Unit Package 1</p>	<p>J86 6139</p> <p>Replaces 826 30-21000AM Gray Unit Package 1</p>
---	---	---

TOYOTA

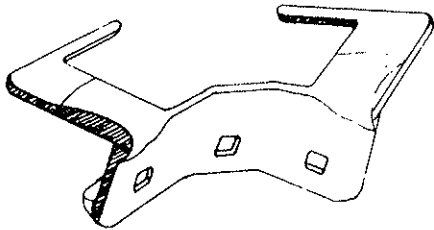

J83 5651

Replaces 75546-14080
Clip, Windshield Moulding
Toyota
UNIT PACKAGE 25

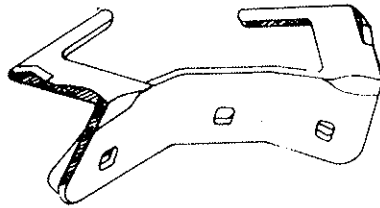

J83 5652

Replaces 75545-14081
Clip, Windshield Moulding
Toyota
UNIT PACKAGE 25

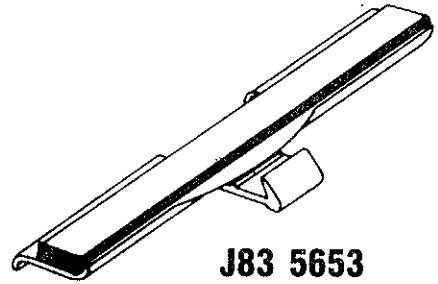

J83 5653

Replaces 75548-24020
Clip Self Adhesive,
Windshield
Toyota
UNIT PACKAGE 10

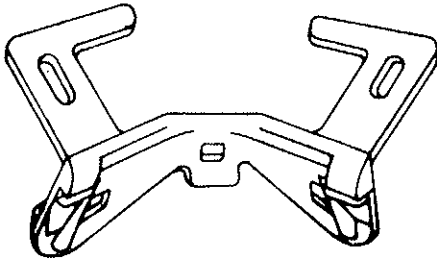

J83 5743

Replaces 75546-22030
Clip, Windshield Moulding
Toyota Cressida '81-82
UNIT PACKAGE 25

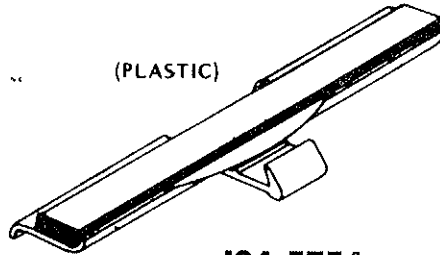

(PLASTIC)

J84 5754

Replaces 75548-32010
Clip, Windshield Moulding
w/ Self Adhesive Backing
Toyota '82/
UNIT PACKAGE 25

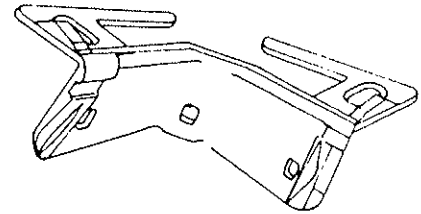

J85 5931

Replaces 75545-28010
Clip, Windshield Moulding
Toyota Van '84/
UNIT PACKAGE 25

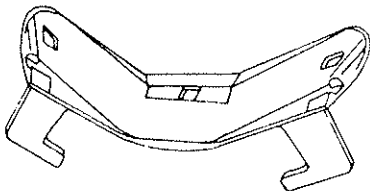

J85 5967

Replaces 75545-89101
Clip, Windshield Moulding
Toyota Pick-Up Trucks '84/
UNIT PACKAGE 25

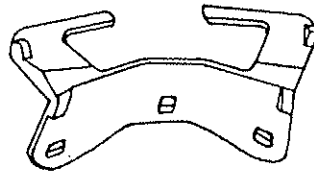

J85 5993

Replaces 75546-12020
94841436
Clip, Windshield Moulding
(Plastic)
Toyota Corolla '84/
G.M. Nova '85/
UNIT PACKAGE 25

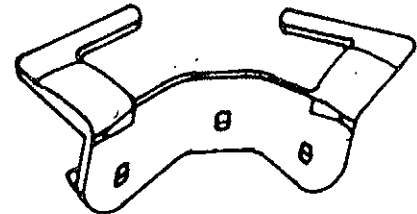

J86 6037

Replaces 75545-12040
Clip, Windshield Moulding,
Plastic.
Toyota Corolla '84/
UNIT PACKAGE 25

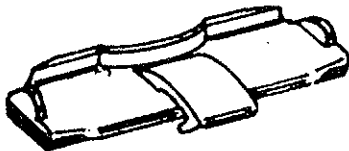

J86 6038

Replaces 75548-89102
Clip, Windshield Moulding,
Self Adhesive Plastic.
Toyota Truck '84/
UNIT PACKAGE 10

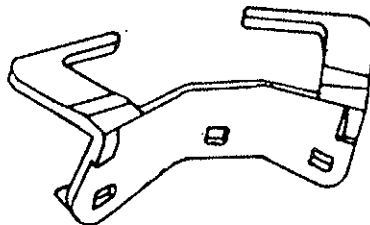

J86 6076

Replaces 75546-32010
Clip, Windshield Moulding,
Plastic.
Toyota Camry '86/
UNIT PACKAGE 25

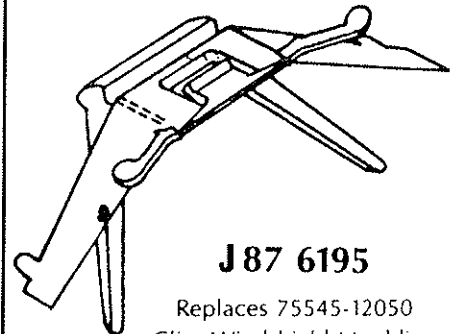

J87 6195

Replaces 75545-12050
Clip, Windshield Moulding
White Plastic
Toyota Corolla (RWD) '84/
UNIT PACKAGE 10

TOYOTA

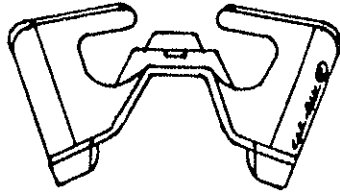

J86 6062

Replaces 75546-28010
Clip. Windshield Moulding.
Plastic.
Toyota Van '85/
UNIT PACKAGE 25

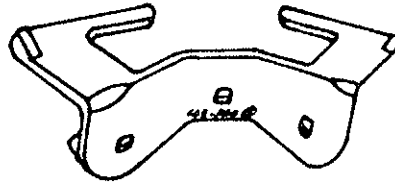

J86 6075

Replaces 75545-32010
Clip. Windshield Moulding.
Plastic.
Toyota Camry '86/
UNIT PACKAGE 25

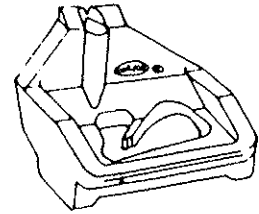

J85 5963

Replaces 75791-14030
Clip. Quarter Window Reveal
Moulding
Toyota, Celica & Supra '82/
UNIT PACKAGE 25

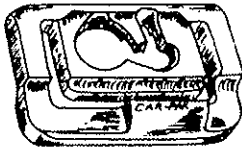

J81 5346

Replaces 75545-12030A
Clip. Windshield Reveal Moulding
Toyota
UNIT PACKAGE 50

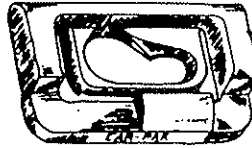

J81 5347

REplaces 75545-30021
Clip. Windshield Reveal Moulding.
Toyota
UNIT PACKAGE 50

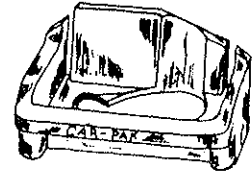

J81 5350

Replaces 75791-14010C
Clip. Drip Moulding
Toyota
UNIT PACKAGE 50

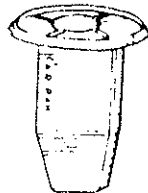

J81 5293

Replaces 01651-00481
Clip. General Purpose
Toyota '78/
UNIT PACKAGE 25

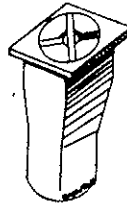

J81 5419

Replaces 90189-04013
Nut, Anchor Type, (Plastic).
Toyota
UNIT PACKAGE 25

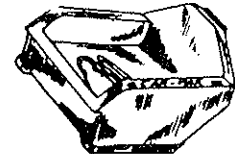

J81 5351

Replaces 75791-20010
Clip. Belt Moulding
Toyota
UNIT PACKAGE 25



J85 5979

Replaces 90189-05012
8941-340-270
Nut. Wide Range M4.2 Screw
Plastic
Various Applications
Toyota Isuzu
UNIT PACKAGE 50



J82 5559

Replaces 90467-08004
90467-08011
Clip. Panel
Toyota
UNIT PACKAGE 50

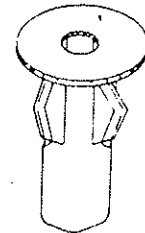

J83 5694

Replaces 96706-W1000
90189-06013
Clip. Fender Shield
Toyota
UNIT PACKAGE 25

TOYOTA



J86 6063

Replaces 67868-89101
Clip, Weatherstrip
Plastic
Toyota Truck
UNIT PACKAGE 50

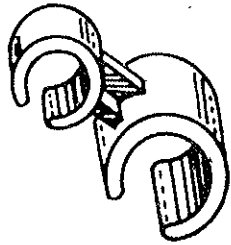

J82 5585

Replaces 90464-00231
Clip, Pipe Clamp
Toyota
UNIT PACKAGE 25

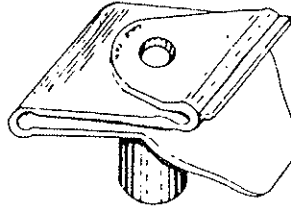

J83 5698

Replaces 53789-14010A
Clip, Inner Fender
M5 Hole
Toyota
UNIT PACKAGE 25

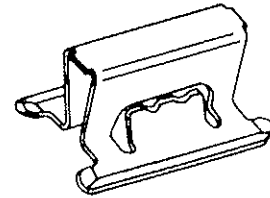

J84 5802

Replaces 90183-03001
Clip, Front Bumper Cushion
Toyota '82/
UNIT PACKAGE 50

MAZDA

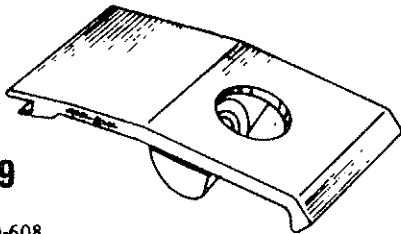

J83 5689

Replaces 8871-50-608
Clip, Windshield Pillar Post
Mazda RX-7 '79
UNIT PACKAGE 25



J85 6009

Replaces HA01-50-609
Clip, Windshield Reveal Moulding
Plastic
Mazda Truck '86/
UNIT PACKAGE 25

AUDI



J82 5480

Replaces 435 853 394
Clip, Windshield Reveal Moulding
Audi 4000 and 5000
UNIT PACKAGE 50

MERCEDES



J76 4263

Replaces 000 988 1581
Hole Size 4.3mm
Nut, Plastic Push in Name Plates and
Insignia:
Mercedes '85/
UNIT PACKAGE 100

MITSUBISHI

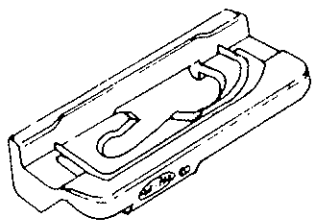

J85 5936

Replaces MB198536
Clip, Windshield Moulding
Dodge Conquest
Mitsubishi Starion '84/
UNIT PACKAGE 25

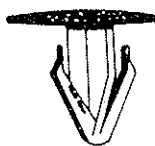

J82 5464

Replaces MB-157841
Dark Grey
Clip, Mat
17mm Head
UNIT PACKAGE 25

VOLKSWAGEN



J70 3384

Replaces 113-853-585C
Clip, Body Side Moulding
Volkswagen
UNIT PACKAGE 50



J73 3827

Nut, License Plate:
Volkswagen
UNIT PACKAGE 100

VOLVO

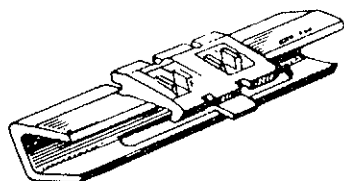

J79 4983

Replaces 1254849
Clip, Windshield Moulding
Stationary Center
Volvo
UNIT PACKAGE 25

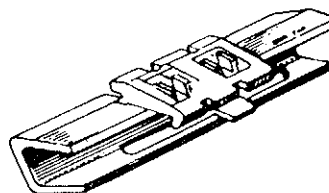

J79 4984

Replaces 1255552
Clip, Windshield Moulding
Stationary Center
Volvo
UNIT PACKAGE 25

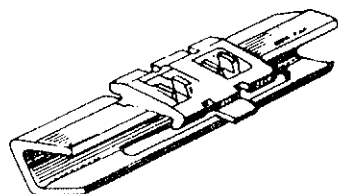

J79 4985

Replaces 1246934
Clip, Windshield Moulding
Sliding Center
Volvo
UNIT PACKAGE 25

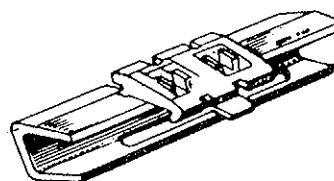

J79 4986

Replaces 1246926
Clip, Windshield Moulding
Sliding Center
Volvo
UNIT PACKAGE 50

MULTIPLE IMPORTS

J76 4334

Replaces 90189-05013
MS-480-002
Nut, Headlamp Bezel & Grille
Toyota, Mitsubishi
UNIT PACKAGE 100



J82 5571

Replaces 01281-00111
90189-06006
Nut, Anchor
Datsun, Toyota
UNIT PACKAGE 50

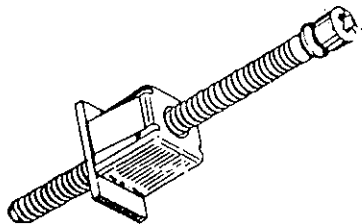

J83 5747

Replaces 8936000-148 AMC
176-941117 V.W.
Screw Size No. 12 x 2 1/8"
Headlamp Adjusting Screw & Nut
AMC Encore & Alliance & V.W.
Products '83/
UNIT PACKAGE 10

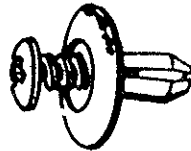

J85 5981

Replaces 80915-29A66
8942-431-900, 9926-50-635
Rivet, Screw Type Hole 6mm
Panel Range 2-5mm
Washer Face 20mm
Plastic
Nissan, Isuzu, Mazda
Various Applications
UNIT PACKAGE 25

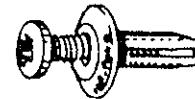

J85 5991

Replaces 90684-SAS-003
10998-30880, 894-298-1190
Rivet, Screw Type, Hole Size M5
Grip Range 2.0 - 6.0mm
Washer Head 15mm
Plastic
Honda Accord: Headlamp Housing
to Grille: '84/, Nissan: Isuzu
Various Applications
UNIT PACKAGE 25

J83 5665

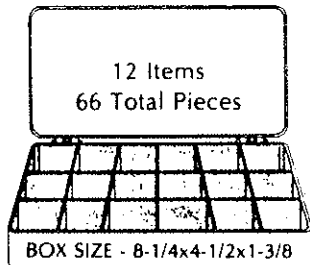

WINDSHIELD & BELT MOULDING CLIPS for JAPANESE CARS

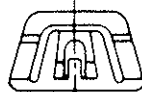

- Contains -



6 each 81-5346	6 each 81-5350	4 each 81-5318
6 each 81-5373	6 each 81-5367	4 each 81-5349
6 each 81-5347	6 each 81-5422	6 each 81-5391
6 each 81-5374	6 each 81-5348	4 each 81-5409

J83 5666

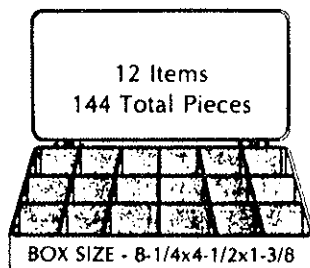

TRIM PANEL ANCHOR NUTS & BUMPER FLAP CLIPS for JAPANESE CARS









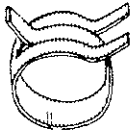
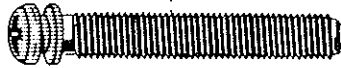

- Contains -

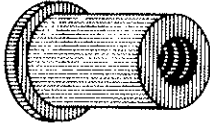

12 each 81-5293	12 each 81-5389	12 each 81-5416
12 each 81-5332	12 each 81-5392	12 each 81-5419
12 each 81-5385	12 each 81-5394	12 each 81-5420
12 each 81-5386	12 each 81-5415	12 each 82-5506

GENERAL PURPOSE

 <p>WINDSHIELD WASHER AND WIPER HOSE CLAMPS</p> <table border="0"> <thead> <tr> <th>PART NO.</th> <th>HOSE O.D.</th> <th>PACK QUAN</th> </tr> </thead> <tbody> <tr> <td>J9411</td> <td>7/16-17/32"</td> <td>25</td> </tr> <tr> <td>J9412</td> <td>17/32-5/8"</td> <td>25</td> </tr> </tbody> </table>	PART NO.	HOSE O.D.	PACK QUAN	J9411	7/16-17/32"	25	J9412	17/32-5/8"	25	 <p>HEADLAMP ADJUSTING SCREWS zinc plated Package 25</p> <table border="0"> <tbody> <tr> <td>J9415</td> <td>#12-28 X 1-1/2"</td> </tr> <tr> <td>J9418</td> <td>1/4-28 X 1-1/2"</td> </tr> <tr> <td>J9419</td> <td>1/4-28 X 2"</td> </tr> </tbody> </table>	J9415	#12-28 X 1-1/2"	J9418	1/4-28 X 1-1/2"	J9419	1/4-28 X 2"	 <p>J87 6296</p> <p>Tapping Screw Phillips No. 8 x 3/4" w/10 Head Black Phosphate Finish Various Interior Applications UNIT PACKAGE 100</p>
PART NO.	HOSE O.D.	PACK QUAN															
J9411	7/16-17/32"	25															
J9412	17/32-5/8"	25															
J9415	#12-28 X 1-1/2"																
J9418	1/4-28 X 1-1/2"																
J9419	1/4-28 X 2"																
 <p>J65 1113</p> <p>Tubular Nut 1/8" Stud Size Replaces Ford 355891, Chrysler Prod. 6000020 UNIT PACKAGE 100</p>	 <p>J9508</p> <p>1/4 - 20 Well Nut for attaching roof or door panel luggage carriers (creates water seal) UNIT PACKAGE 25</p>																
 <p>J609</p> <p>Speed Nuts Flat Push-On Types 1/16" Stud Size UNIT PACKAGE 25</p>	 <p>J610</p> <p>3/2" Stud Size</p>	 <p>J612</p> <p>Speed Nuts Flat Push-On Types 5/32" Stud Size UNIT PACKAGE 25</p>															
 <p>J613</p> <p>Speed Nuts Flat Push-On Types 3/16" Stud Size UNIT PACKAGE 25</p>	 <p>J614</p> <p>Speed Nuts Flat Push-On Types 3/16" Stud Size UNIT PACKAGE 25</p>	 <p>J615</p> <p>Speed Nuts Flat Push-On Types 1/4" Stud Size UNIT PACKAGE 25</p>															

GENERAL PURPOSE



J1039

Speed Nut
Flat Push-On Types
1/8" stud size
UNIT PACKAGE 50



J845

No. 14 Sheet Metal Screw



J1789

No. 8 Sheet Metal Screw



J1350

No. 10 Sheet Metal Screw



J1303

1/4-20 Machine Screw



J77 4692

Replaces 387258-S Ford 20032850 G M
3861577 Chrysler
Stone Shield Clip
Ford, Chrysler and General Motors
Products '76/
UNIT PACKAGE 100

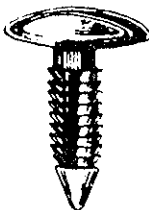

J76 4384

Replaces 1605396
Clip, Plastic Shield, Fenders and Engine
Compartment
General Motors Cars '76/, Chrysler Products
'76/, Ford Products '76/
UNIT PACKAGE 100



J72 3567

Replaces 2898909, 382570-S
Fastener, Dash and Cowl
Panel, Nylon:
G. M., Chrysler and Ford Products '70-'72
UNIT PACKAGE 100



J71 3456

Universal T Bolt
10- 24 x 5/8" Bolt
UNIT PACKAGE 50

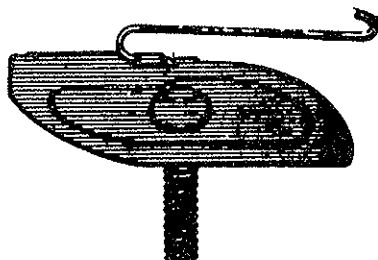

J71 3457

Universal T-Bolt
10-24 x 5/8" Bolt
UNIT PACKAGE 50

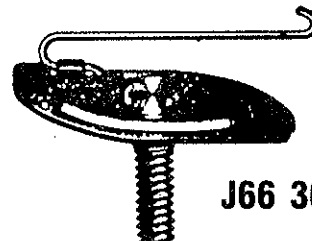

J66 3066

Universal Type Moulding
T-Bolt: General Purpose,
All Cars, All Models: Bolt
Size and Length
10-24x3/4".
Plate Size 1 7/16x1/2"
UNIT PACKAGE 100



J72 3704

Replaces 332364, 4004569
Clip, Plastic Shield Fenders
and Engine Compartment:
Chevrolet and
American Motors
UNIT PACKAGE 100

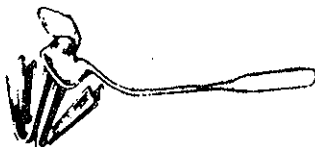

J68 3206



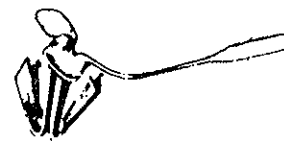



Universal Moulding Clip,
Push In Type:
General Purpose All Cars
(Illustration Actual Size)
UNIT PACKAGE 50



J68 3217

Push-In Type Clip:
General Purpose
(Illustrated Actual Size)
UNIT PACKAGE 50

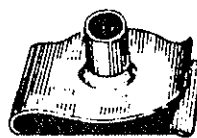
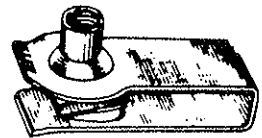
GENERAL PURPOSE

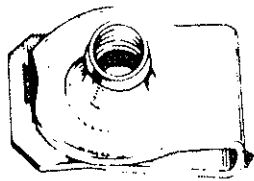
 <p>J74 4062 Nut, Side Marker Lamps 5/16" Stud Size Ford and General Motors Cars, Also General Purpose UNIT PACKAGE 100</p>	<p>J74 4063 1/8" Stud Size 7/16" Washer Diameter</p> <p>J74 4064 3/16" Stud Size 1/2" Washer Diameter</p>	 <p>J74 4065 5/32" Size 9/16" Washer Diameter</p> <p>Thread Cutting Nut: General Purpose UNIT PACKAGE 100</p> <p>J74 4066 1/4" Stud Size 11/16" Washer Diameter</p>
 <p>J77 4448 8-18 X1 Type AB Phosphate Screw, Hex Head With Flat Washer General Purpose: UNIT PACKAGE 100</p>	<p>J73 3807 8-18 X 5/8"</p> <p>J73 3808 8-18 X 3/4"</p>	 <p>J73 3809 8-18 X 1"</p> <p>Chrome Plated, Phillips Oval Head Trim Screws With Countersunk Washer UNIT PACKAGE 100</p> <p>J73 3810 8-18 X 1 1/4"</p>
 <p>J72 3572 Replaces 9616231, 384939 S47 Self Drilling Screw, Wheel House Moulding General Motors and Ford Cars. General Usage UNIT PACKAGE 50</p>	 <p>J66 3029 (Replaces 3786805) Extruded U-Nut 5/16-18, Panel Range 025-060: General Usage: Ford and Chrysler Products UNIT PACKAGE 100</p>	 <p>J70 3414 5/16-18 Extruded Nut, 025-150 Range, Long Throat General Purpose. UNIT PACKAGE 50</p>
 <p>J72 3629 Replaces 3971639, 405225 Extruded Nut, "U" Type, 5/16-18, Wide Panel Range G.M. '69-'72 General Purpose UNIT PACKAGE 50</p>		 <p>J72 3698 Replaces 1494254 3/8 x 16 Multi-Range (050-200) Extruded U-Nut General Usage, Fenders & Shrouds All Car Lines UNIT PACKAGE 25</p>

GENERAL PURPOSE

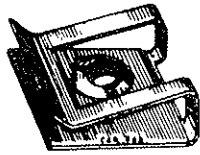

J74 3941

Replaces 9431530
Screw Size #8-18, Panel Range
025-150

Wide Range U-Nut. Steering
Column, Head Lamp, Instrument
Panel, Rear Lamp, Fuel Tank
Floor, Dome Lamp, Glove Box
Striker, Console, Parking Lamp,
Rear Bumper Filler, Windshield
Washer Nozzle, Air Cleaner,
Radiator Grille, Ash Tray, Front
Door Trim Panel, Side Marker
Lamp, Front End Filler, Head Light
Adjust Screw, Air Cleaner
Adapter Duct:

Chevrolet, Pontiac, Buick &
Oldsmobile '71 - '75. Also
General Purpose.

UNIT PACKAGE 100

FLANGED "PAL" NUTS



(zinc plated)

	THREAD SIZE	FLANGE DIAM.
J9612	#10-32	1/2"
J9613	#10-24	1/2"
J9614	#10-24	3/4"
J9615	1/4-20	19/32"

UNIT PACKAGE 25

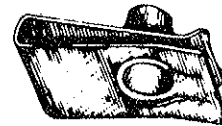

J71 3454

1/4-20 Short Throat,
Extruded Nut Wide Range

UNIT PACKAGE 25



Pushnut Retainers UNIT PACKAGE 100

	Bolt Size	O.D.
J75 4117	No. 6	11/32"
J75 4118	No. 8	3/8"
J75 4119	No. 10	7/16"
J75 4120	1/4"	1/2"
J75 4121	5/16"	5/8"
J75 4122	3/8"	25/32"
J74 4067	7/16"	27/32"
J75 4123	1/2"	15/16"

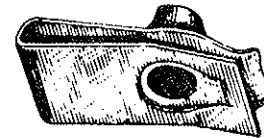

J71 3455

1/4-20 Long Throat
Extruded Nut Wide Range

UNIT PACKAGE 50

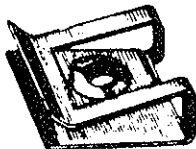

J74 3940

Replaces 9433056
Screw Size #10-16 Panel Range
.100-250

Wide Range U-Nut. Coolant
Recovery Tank

Pontiac '71 - '75. Also General
Purpose.

UNIT PACKAGE 100



J77 4643

Replaces 9433156
8-18 Panel Range
.125-250

Nut, Wide Range:
General Purpose: General Motors.

UNIT PACKAGE 100



J77 4707

Replaces 554343 G M 3231651 AMC
Clip, Bumper Strips
American Motors 777, Oldsmobile,
Buick, Chevrolet 777

UNIT PACKAGE 100

PIGTAIL SOCKET ASSEMBLIES W/16 GAUGE/10" WIRE LEADS
The pigtail socket assemblies are not supplied separately by the
factories only as part of the entire electrical wire harness. The socket
assemblies locking tabs are vulnerable during removal and also the
sockets can be damaged in the front end collision.

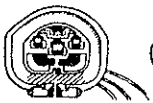

J87-6233

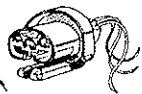

J87-6234

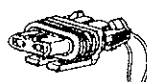

J87-6235

S & S Part No.

J87 6233
J87 6234 (w/seal)
J87 6235 (w/seal)

APPLICATION

For 9004 Bulb 3 Prong
For 9005 Bulb 2 Prong
For 9006 Bulb 2 Prong

QTY

5/PKG
5/PKG
5/PKG



J75 4150

Replaces 5/16" Stud Size
Speed Nut, Push On Type:
General Purpose.

UNIT PACKAGE 100

TRIM SCREWS

PHILLIPS OVAL-TYPE "AB" WITH 3/8" DIAMETER ROUND WASHER HEAD



ZINC PLATED		UNIT PKG.
J73 3908	8-18 x 1/2 in.	100
J73 3909	8-18 x 3/4 in.	100
J73 3910	8-18 x 1 in.	100
J73 3911	8-18 x 1 1/4 in.	100

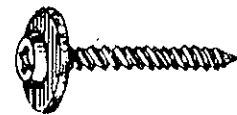

PHOSPHATE AND OIL		UNIT PKG.
J73 3912	8-18 x 1/2 in.	100
J73 3913	8-18 x 3/4 in.	100
J73 3914	8-18 x 1 in.	100
J73 3915	8-18 x 1 1/4 in.	100

PHILLIPS OVAL-TYPE "AB" WITH 1/2" DIAMETER ROUND WASHER HEAD



ZINC PLATED		UNIT PKG.
J85 5907	8-18 x 3/4 in.	100
J85 5908	8-18 x 1 in.	100
J85 5909	8-18 x 1 1/4 in.	100
J85 5910	10-16 x 3/4 in.	100
J85 5911	10-16 x 1 in.	100
J85 5912	10-16 x 1 1/4 in.	100
J85 5913	10-16 x 1 1/2 in.	100



PHOSPHATE AND OIL (BLACK)		UNIT PKG.
J85 5899	8-18 x 3/4 in.	100
J85 5900	8-18 x 1 in.	100
J85 5901	8-18 x 1 1/4 in.	100
J85 5902	10-16 x 3/4 in.	100
J85 5903	10-16 x 1 in.	100
J85 5904	10-16 x 1 1/4 in.	100
J85 5905	10-16 x 1 1/2 in.	100

PHILLIPS OVAL HEAD TRIM SCREW WITH COUNTER SUNK WASHER TYPE "AB"



CHROME PLATED		UNIT PKG.
J73 3807	8-18 x 5/8 in.	100
J73 3808	8-18 x 3/4 in.	100
J73 3809	8-18 x 1 in.	100
J73 3810	8-18 x 1 1/4 in.	100
J81 5438	10-16 x 3/4 in.	50
J81 5439	10-16 x 1 in.	50
J81 5440	10-16 x 1 1/4 in.	50



BLACK PHOSPHATE		UNIT PKG.
J80 5156	8-18 x 5/8 in.	100
J80 5157	8-18 x 1 in.	100
J81 5442	10-16 x 3/4 in.	50
J81 5443	10-16 x 1 in.	50
J81 5444	10-16 x 1 1/4 in.	50

PHILLIPS ROUND WASHER HEAD



J4091	8-8 x 3/8 in.-3/8" washer diam.	100
J1979	8-8 x 3/8 in.-7/16" washer diam.	100

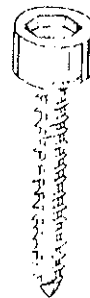

J80 5287

Replaces 489941
8 - 18 x 3/4 in. Type AB
No. 10 Head
Socket Head Screw Console
Attaching
Chevrolet & Pontiac
UNIT PACKAGE 50

TRIM SCREWS

UNDERSIZE HEAD

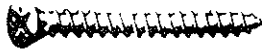

CHROME PLATED

PHILLIPS NO. 6 OVAL HEAD

		UNIT PKG.
J73 3883	8 x 1/2 in.	100
J73 3884	8 x 3/4 in.	100
J73 3885	8 x 1 in.	100
J73 3886	8 x 1 1/4 in.	100
J73 3887	8 x 1 1/2 in.	100

PHILLIPS NO. 8 OVAL HEAD

J73 3889	10 x 3/4 in.	100
J73 3890	10 x 1 in.	100
J73 3892	10 x 1 1/2 in.	100

BLACK PHOSPHATE AND OIL PLATE

PHILLIPS NO. 6 OVAL HEAD

		UNIT PKG.
J73 3866	8 x 1/2 in.	100
J73 3867	8 x 3/4 in.	100
J73 3868	8 x 1 in.	100
J73 3869	8 x 1 1/4 in.	100
J73 3870	8 x 1 1/2 in.	100
J73 3871	8 x 1 3/4 in.	100

PHILLIPS NO. 8 OVAL HEAD

J73 3876	10 x 3/4 in.	100
J73 3877	10 x 1 in.	100
J73 3878	10 x 1 1/2 in.	100

STANDARD HEAD



BLACK PHOSPHATE & OIL PLATE CASE HARDENED

		UNIT PKG.
J73 3857	6 x 3/4 in.	100
J73 3858	6 x 1 in.	100
J73 3860	8 x 1/2 in.	100
J73 3861	8 x 3/4 in.	100
J73 3862	8 x 1 in.	100
J73 3963	8 x 1 1/4 in.	100
J73 3864	8 x 1 1/2 in.	100
J73 3872	10 x 3/4 in.	100
J73 3873	10 x 1 in.	100
J73 3874	10 x 1 1/2 in.	100

SHEET METAL SCREWS

PHILLIPS OVAL HEAD



		UNIT PKG.
J255	4 x 1/2 in.	100
J256	4 x 3/4 in.	100

PHILLIPS PAN HEAD



J2697	8 x 3/4 in.	100
-------	-------------	-----

PHILLIPS FLAT HEAD

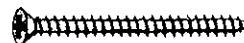

J2688	8 x 1/2 in.	100
J2692	8 x 3/8 in.	100

BRASS MACHINE SCREWS

ROUND HEAD UNPLATED



		UNIT PKG.
J471	6-32 x 1/2 in.	100
J472	6-32 x 3/4 in.	100

TORX DRIVE SCREWS

Torx Drive. Oval Head. Trim Screws, Undersized Heads. AB Point

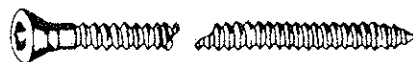

CHROME PLATED

PART NO.	REPLACES	SIZE	UNIT PKG.
J79 5032	11504550	4.2mm-1.41 x 16mm	50
J79 5034	11504069	4.2mm-1.41 x 20mm	50
J79 5036	11504551	4.2mm-1.41 x 25mm	50
J79 5037	11504522	4.2mm-1.41 x 30mm	50
J79 5120	11504679	4.2mm-1.41 x 70mm	50

BLACK OXIDE

PART NO.	REPLACES	SIZE	UNIT PKG.
J79 5033	11504660	4.2mm-1.41 x 16mm	50
J79 5035	11504659	4.2mm-1.41 x 20mm	50
J79 5038	11504656	4.2mm-1.41 x 30mm	50
J79 5043	11504844	4.2mm-1.41 x 70mm	50

Torx Drive. Oval Head Trim Screws, Regular Heads. AB Point



BLACK OXIDE

PART NO.	REPLACES	SIZE	UNIT PKG.
J79 5044	11504478	4.2mm-1.41 x 20mm	50

Torx Drive. Pan Head Screws. AB Point

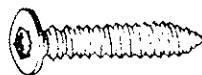

CHROME PLATED

PART NO.	REPLACES	SIZE	UNIT PKG.
J79 5047	11504661	4.2mm-1.41 x 25mm	50
J79 5049	11504663	4.2mm-1.41 x 35mm	50

BLACK OXIDE

PART NO.	REPLACES	SIZE	UNIT PKG.
J79 5048	11504662	4.2mm-1.41 x 25mm	50
J79 5046	11504655	4.2mm-1.41 x 20mm	50

MISC. SCREWS



TEKS®
SELF-DRILLING • SELF-TAPPING • FASTENERS
 ZINC PLATED

HEX WASHER HEAD

		UNIT PKG.
J77722	8 x 1/2 in.	25
J77723	8 x 5/8 in.	25
J77724	8 x 3/4 in.	25
J77726	8 x 1 in.	25
J77736	10 x 1/2 in.	25
J77737	10 x 5/8 in.	25
J77738	10 x 3/4 in.	25
J77739	10 x 1 in.	25
J77757	12 x 3/4 in.	25
J77759	12 x 1 in.	25
J77762	14 x 3/4 in.	25
J77764	14 x 1 in.	25

PHIL PAN

J77822	8 x 1/2 in.	25
J77824	8 x 3/4 in.	25

HEXAGON WASHER HEAD TAPPING SCREWS
 WASHER LOOSE FROM HEAD
 (Bright Zinc Chromate)

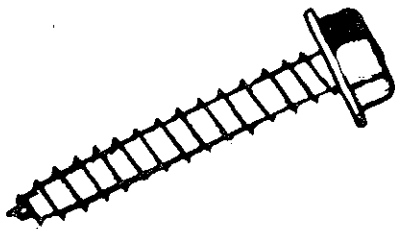

PART NO.	SIZE	HEAD SIZE	UNIT PKG.
J2604	14 x 3/4 in.	3/8 in.	100
J2988	14 x 3/4 in.	7/16 in.	100
J2605	14 x 1 in.	3/8 in.	100
J2989	14 x 1 in.	7/16 in.	100

HEX WASHER HEAD

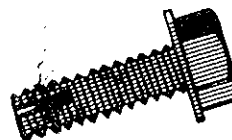

		UNIT PKG.
J856	5/16 x 3/4 in.	50
J877	5/16 x 1 in.	50

HEXAGON HEAD WITH LOOSE WASHER

3/4" WASHER



J837	14 x 3/4 (7/16 ATF)	UNIT PKG. 100
------	---------------------	---------------------

SPECIAL FASTENERS

BUMPER BOLTS

DORMAN BUMPER BOLTS — PACKED 25 PER BOX

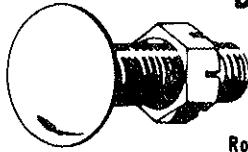

Round Head
ROUND HEAD

STAINLESS STEEL CAPS
BRIGHT PLATED BOLTS
Threaded U.S.S.
with Bright Plated
U.S.S. Self-Locking Nuts

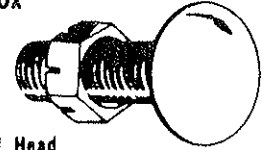

Round Head
ROUND HEAD

Part Number	Size Dia.—Length	Quan. in Jobber Stock
J605-005	5/16" x 1 1/4"	10
J605-006	7/16" x 1 1/2"	10
J605-016	7/16" x 1"	10
J605-018	1/2" x 1 1/4"	10

Part Number	Size Dia.—Length	Quan. in Jobber Stock
J605-019	1/2" x 1 1/2"	10
J605-021	3/8" x 1"	10
J605-022	3/8" x 1 1/4"	10
J605-023	5/16" x 3/4"	10

DORMAN LICENSE PLATE BOLTS

BRIGHT PLATED — CHROMATE COATED



Part Number	Size and Type			Standard Package
	Bolt	Nut	Washers	
J395-002	1/4" x 1/2"	1/4" Hex	1/4" Washer Head Bolt	100

BATTERY BOLTS & NUTS

BRIGHT PLATED — CHROMATE COATED



(includes nut and bolt)

392-003

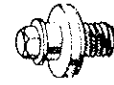

392-004

(directly into battery side post)

Part Number	Standard Package	Nut Size	Bolt Size and Type	Thread
J392-003	100	5/16" Special	5/16" x 1 1/4" Square Head	U.S.S.
J392-004	25	None Used	3/8" x 3/8" Small Hex (Side)	U.S.S.

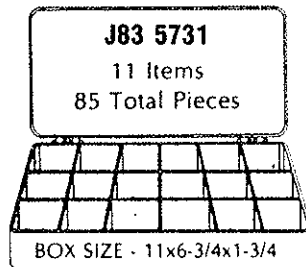

REPLACEMENT DOOR HINGE PINS & BUSHINGS
for G.M., FORD & CHRYSLER CARS

— Contains —

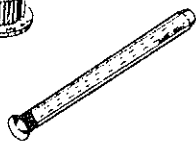

10 each J81 5307
10 each J81 5308
10 each J83 5711
10 each J83 5712

10 each J83 5724
10 each J83 5725
5 each J83 5707

5 each J83 5709
5 each J83 5710
5 each J83 5737
5 each J83 5738

FASTENERS

VACUUM CONNECTORS - EMISSION HARNESS HEAT & CHEMICAL RESISTANT RUBBER

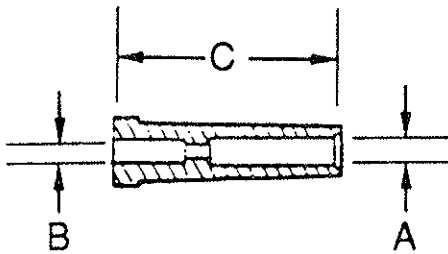

TYPE 1

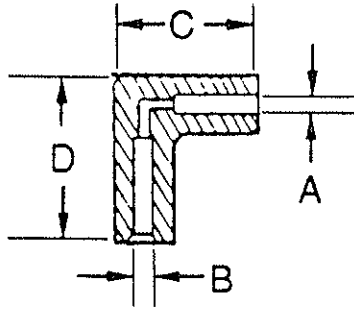

TYPE 2

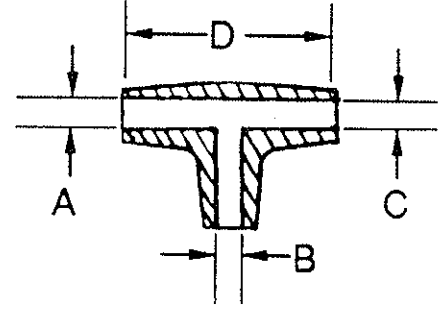

TYPE 3

PART NUMBER	O.F.M. NUMBER	TYPE	A INCH/mm	B INCH/mm	C INCH/mm	D INCH/mm	UNIT pkg.
J88-6455	25517507	1	.110/2.85	.160/4.14	1.46/37.0		10
J88-6456	4179391	1	.120/3.05	.160/4.14	1.31/33.3		10
J88-6457	12047609	1	.120/3.40	.230/5.50	1.30/32.9		10
J88-6458	25517954	2	.120/3.05	.120/3.05	.89/22.5	.56/14.2	10
J88-6459	4213774	2	.120/3.05	.150/3.80	1.01/25.5	.91/22.9	10
J88-6460	14084916	2	.135/3.43	.150/3.80	1.01/25.5	.91/22.9	10
J88-6461	12059749	2	.150/3.80	.220/5.59	.93/23.6	1.1/27.6	10
J88-6462	22518657	3	.110/2.85	.110/2.85	.110/2.85	1.6/40.0	10

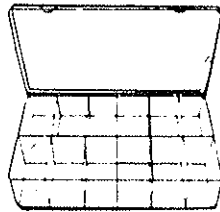

J99085 EMISSION CONNECTOR ASSORTMENT

Includes: 5 pieces of each connector
plus 12 compartment see-thru tray.

J81225
F Connector
3/16" All Ends
GM, General Purpose
Unit Package 10

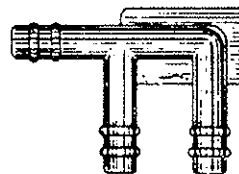

SPECIAL FASTENERS

HOSE AND TUBING PLASTIC CONNECTORS

Chemical resistant, high impact nylon. Packaged 10 per part no.



Part No.	A	B	C
J81210	1/8	1/8	1/8
J81211	3/16	3/16	3/16
J81212	1/4	1/4	1/4
J81213	5/16	5/16	5/16
J81214	3/8	3/8	3/8
J81215	1/8	3/16	1/8
J81216	3/16	1/8	3/16
J81217	3/16	1/4	3/16
J81218	3/16	3/16	1/8
J81219	1/4	3/16	3/16
J81220	5/16	3/8	3/8
J81221	3/8	3/8	1/4
J81222	3/8	1/4	3/8

CONNECTORS

Part No.	A	B
J81230	1/8	1/8
J81231	3/16	3/16
J81232	1/4	1/4
J81233	5/16	5/16
J81234	3/8	3/8
J81235	1/8	3/16
J81236	1/8	1/4
J81237	3/16	1/4

RESTRICTOR CONNECTORS



Part No.	A	B
J81238	3/16	3/16

FOUR WAY TEE

Part No.	A	B
J81223	3/16	All Ends

FIVE WAY TEE

Part No.	A	B
J81224	3/16	All Ends

ELBOWS



Part No.	A	B
J81250	3/16	3/16
J81251	1/4	1/4
J81252	1/8	3/16
J81253	3/16	1/4

WYE



Part No.	A	B	C
J81240	3/16	3/16	3/16
J81241	1/4	1/4	1/4
J81242	5/16	5/16	5/16
J81243	1/4	1/4	3/16
J81244	1/4	3/8	3/8

VACUUM LINE CAP-RUBBER

Part No.	A
J81259	1/8
J81260	3/16
J81261	1/4
J754163	3/8

SPECIAL FASTENERS



LIGHT DUTY STEEL TUBING CLAMPS
zinc plated
black vinyl plastisol coated
(1/4" bolt hole - 1/2" wide)

PART NO.	TUBING DIAM.	THICK-NESS	PACK. QUAN.
J9311	1/4"	.025	25
J9312	5/16"	.025	25
J9313	3/8"	.025	25
J9314	1/2"	.025	25
J9315	5/8"	.025	25
J9316	3/4"	.025	25
J9317	1"	.025	25

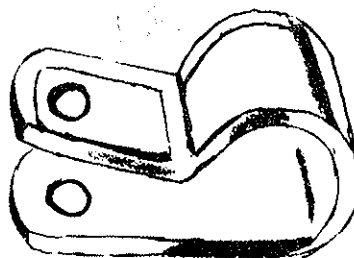

NYLON TUBING CLAMPS

PART NO.	TUBE SIZE	WIDTH	HOLE SIZE	THICK-NESS	PACK. QUAN.
J9301	1/4"	3/8"	#8	.040	25
J9302	5/16"	3/8"	#8	.040	25
J9303	3/8"	3/8"	#8	.040	25
J9304	1/2"	3/8"	#8	.040	25
J9305	5/8"	3/8"	#8	.040	25
J9307	1"	1/2"	#10	.060	25

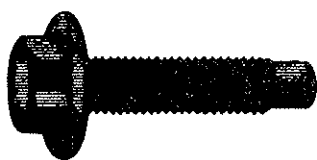

SPINLOCK BODY BOLTS

(black finish)

PART #	SIZE	PKG.
*J9450	5/16—18 x 3/4	50/pk
*J9451	5/16—18 x 1	25/pk
*J9452	5/16—18 x 1 1/4	25/pk
J9453	3/8—16 x 3/4	25/pk
J9454	3/8—16 x 1 1/8	25/pk

(* Denotes dog point)

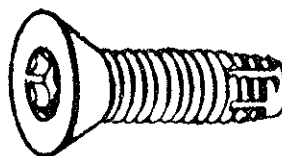

FLOOR BOARD SCREWS FLAT TORX/IN STEEL PHOS/OIL TAPPING SCREW

J30010B	1/4—20 x 1—1/2
J30012B	1/4—20 x 2-inch
J30014B	1/4—20 x 2—1/2
J30016B	1/4—20 x 3-inch
J30024B	5/16—18 x 2-inch

SPECIAL FASTENERS

—License Plate Screws and Nuts—

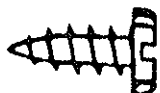

Slotted Pan Head Tapping Screw
J77071 #14 x 5/8 A point



Slotted Truss Head Tapping Screw
J77271 #14 x 3/4 A point

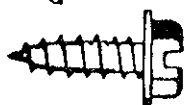

Slotted Hex Washer Head Tapping Screw
J77665 #14 x 3/4 A point

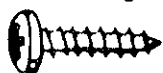

Phillips Pan Head Tapping Screw
J77346 #14 x 5/8 A point



Slotted Round Washer Head Tapping Screw
J77500 #14 x 5/8 Blunt point



Phillips Pan Head
J66030 M6 x 20-Black

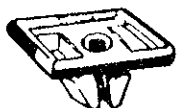

Plastic Nut
J774474 Ford style 4-prong

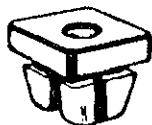

Plastic Nut
J673130 4-prong



Plastic Nut
J651090 2 prong



Dealer Plate Thumb Screw
J9666 Qty: 50/box

SPECIAL FASTENERS

—License Plate Screws and Nuts—



Slotted Pan Head Tapping Screw
J77022 #8 x 1/2 A point



Slotted Pan Head Tapping Screw
J77023 #8 x 5/8 A point



Slotted Truss Head Tapping Screw
J77241 #8 x 1/2 A point



Slotted Truss Head Tapping Screw
J77242 #8 x 5/8 A point



Phillips Pan Head Tapping Screw
J77307 #8 x 1/2 A point



Phillips Pan Head Tapping Screw
J77308 #8 x 5/8 A point



Phillips Round Washer Head Tapping Screw
J77486 #8 x 1/2 A point



Phillips Round Washer Head Tapping Screw
J77487 #8 x 3/4 A point



Slotted Hex Washer Head Tapping Screw
J77626 #8 x 1/2 A point



Slotted Hex Washer Head Tapping Screw
J77628 #8 x 3/4 A point



Plastic Nut
J733827 2-prong. Takes #8 screw



J9620

Screw, M6-1.00 x 20mm
Nut, M6-1.00
Black Nylon
License Plate Screw/Nut
Metric Pan Head Slotted
M/S w/Hex Nut

Unit Package: 25 Sets



SLOTTED NYLON
LICENSE BOLT WITH
NYLON HEX NUTS

J9506 Pkg. 25
1/4-20 X 9/16"

SPECIAL FASTENERS

THREADED ROD

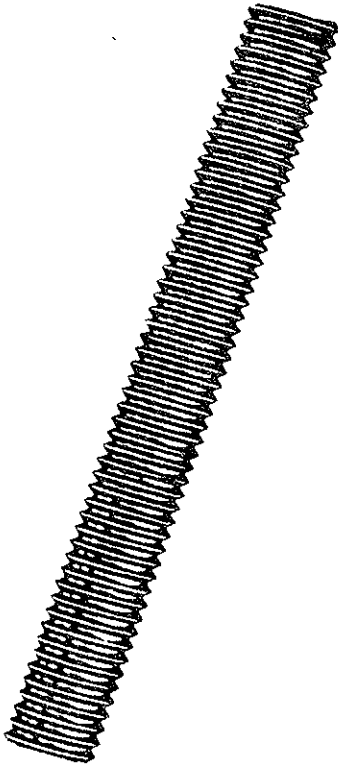

PLATED		UNPLATED	
PART NO.	PART NO.	DIAM.	THREAD
J80021	J80031	1/4-20	USS
	J80081	1/4-28	SAE
J80022	J80032	5/16-18	USS
	J80082	5/16-24	SAE
J80023	J80033	3/8-16	USS
	J80083	3/8-24	SAE
J80024	J80034	7/16-14	USS
	J80084	7/16-20	SAE
J80025	J80085	1/2-13	USS
	J80036	1/2-20	SAE
J80026		5/8-11	USS
J80027	J80037	3/4-10	USS
J80028	J80038	7/8-9	USS
J80029	J80039	1-8	USS

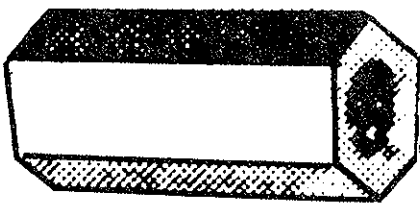

STEEL COUPLING NUTS FOR THREADED ROD

- DOUBLE CHAMFERED, DOUBLE COUNTER-SUNK HEX NUTS
- PLATED FOR CORROSION RESISTANCE
- FOR USE TO COUPLE RODS TOGETHER AND CAN ALSO BE USED WITH STUDS FOR REPAIR OR FOR EXTENSIONS

COUPLING NUT ZINC PLATED

PART NO.	THREAD	LENGTH	FLATS
J80011	1/4-20	7/8"	3/8"
J80012	5/16-18	1 1/8"	1/2"
J80013	3/8-16	1-3/4"	5/8"
J80014	7/16-14	1-3/4"	11/16"
J80015	1/2-13	1-3/4"	11/16"
J80016	5/8-11	2-1/8"	13/16"
J80017	3/4-10	2-1/4"	1"
J80018	7/8-9	2-1/2"	1-1/4"
J80019	1-8	2 3/4"	1 3/8"

yoke ends

SELF-COLORED DROP FORGED YOKE ENDS

ADJUSTABLE

S.A.E. STANDARDS

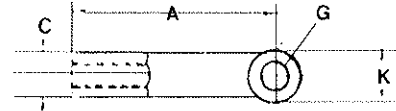
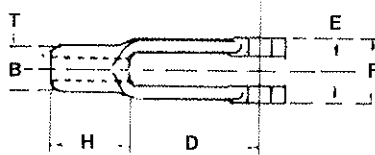

STK. NO.	"T" TAP SIZE	DIMENSIONS IN INCHES - MACHINED								
		A	B	C	D	E	F	G	H	K
J80151	1/4-28	2	7/16	7/16	1-1/4	9/32	5/8	1/4	3/4	1/2
J80152	5/16-24	2-1/4	1/2	1/2	1-7/16	11/32	3/4	5/16	13/16	19/32
J80153	3/8-24	2-1/2	5/8	5/8	1-5/8	7/16	7/8	3/8	7/8	11/16
J80154	7/16-20	2-7/8	23/32	23/32	1-7/8	1/2	1	7/16	1	13/16
J80155	1/2-20	3	13/16	13/16	1-7/8	9/16	1-1/8	1/2	1-1/8	15/16

SELF-COLORED S.A.E. CLEVIS PINS FOR YOKE ENDS



Shank Dia.	DIMENSIONS IN INCHES					
	Lengths		Head		Hole	
	Overall	Under Head	O.D.	Thickness	I.D.	*Center
J80161	55/64	49/64	3/8	3/32	5/64	43/64
J80162	1-1/32	15/16	7/16	3/32	7/64	13/16
J80163	1-3/16	1-1/16	1/2	1/8	7/64	15/16
J80164	1-11/32	1-3/16	9/16	5/32	7/64	1-1/16

*from under head

ASSORTMENTS

SECTION 3

	PAGE
BRAKE BLEEDER SCREW ASSORTMENT #J99060.....	6
CONNECTOR ASSORTMENTS:	
Air Conditioning O-Ring Assortment #J99090.....	7
Connector Assortment-Large Drawer #J99051.....	11
Connector Assortment-Small Drawer #J99052.....	11
'E' Ring Assortment #J99062.....	8
Elbow, Wye, Vacuum Cap Assortment #J99021.....	5
Emission Connector #J99085.....	7
Hairpin Retainer Assortment #J99061.....	8
Hose & Tubing Connectors #J99019.....	4
Pushnut Retainer Assortment #J99064.....	8
Restrictor & Tee Assortment #J99020.....	5
Rivet Assortment-Nylon #J835727.....	10
COPPER WASHERS.....	1
COTTER PIN ASSORTMENT #J99014.....	3
DRAIN PLUG GASKETS.....	1
DRILL SCREW ASSORTMENT (BI-ARC) #J99070.....	6
ELECTRICAL TERMINAL ASSORTMENTS:	
Large Drawer #J99035.....	10
Plastic Tray #J99013.....	2
Small Drawer #J99036.....	10
"E" RING ASSORTMENT #J99062.....	8
GRADE 5 USS ASSORTMENT-CAP SCREWS, NUTS, WASHERS #J99025.....	16
GRADE 5 USS AND STANDARD METRIC ASSORTMENT-CAP SCREWS, NUTS, WASHERS #J99026.....	16
GRADE 8 SAE ASSORTMENT-CAP SCREWS, NUTS, WASHERS #J99003.....	15
GRADE 8 USS ASSORTMENT-CAP SCREWS, NUTS, WASHERS #J99002.....	15
GRADE 8 USS AND STANDARD METRIC ASSORTMENT-CAP SCREWS, NUTS, WASHERS #J99027.....	16
GREASE FITTING ASSORTMENT #J99086.....	7
HAIRPIN RETAINER ASSORTMENT #J99061.....	8
MACHINE SCREW ASSORTMENTS:	
Slotted Flat Head #J99017.....	3
Slotted Round Head #J99016.....	3
METRIC ASSORTMENTS:	
Door Hinge Pins/Bushings-Domestic Veh's.....	19
GM Universal Metric Hardware Assortment #J99000.....	18
GM Universal Metric Hardware Assortment #J99010.....	17
Small Head Metric-Large Drawer #J99041.....	12
Small Head Metric-Small Drawer #J99040.....	12
Standard Metric Assortment-Cap Screws, Nuts, Washers, Small: #J99023 #J99024.....	11
Standard Metric Assortment-Cap Screws, Nuts, Washers #J99004.....	15
Trim Panel Anchor Nuts & Bumper Clips-Japanese Veh's.....	19

NYLON GASKETS.....	1
PUSHNUT RETAINER ASSORTMENT #J99064.....	8
RIVET ASSORTMENT-ALUMINUM #J99018.....	4
ROLL PIN ASSORTMENT #J99058.....	7
SHEET METAL SCREW ASSORTMENTS:	
Hex Head & Slotted Hex Washer Head #J99008.....	14
Phillips Oval Head #J99006.....	13
Phillips Round Washer Head #J99001.....	9
Phillips Round Washer Head #J99012.....	2
Slotted Flat Head #J99007.....	13
Slotted Hex Washer Head #J99015.....	3
Slotted Oval Head #J99005.....	13
Slotted Pan Head #J99009.....	14
Slotted Pan, Oval & Flat #J99011.....	2
TRIM SCREW ASSORTMENTS:	
Large Trim Screw Assortment #J99053.....	12
Small Trim Screw Assortment #J99054.....	12
Torx Trim Screw-Large Assortment #J99075.....	9
Torx Trim Screw-Small Assortment #J99022.....	6
VU-PAK ASSORTMENTS.....	1

VU-PARTS

ASSORTMENTS

"Dial-a-size"
and pour!



J71120 DRAIN PLUG

GASKETS: 6 Copper Gaskets 3 each in 1/2" and 9/16" I.D., 15 Nylon Gaskets in 1/2", 5/8", 3/4" and 9/16" I.D.



J71121

NYLON GASKETS: 32 Nylon Gaskets in 1/2", 5/8", 11/16", 3/4", 57/64", & 9/16" I.D.



J71127

COPPER WASHERS: 7 Pieces each of 1/4", 5/16", and 3/8" Diameter - 1/32" thick.

ASSORTMENTS

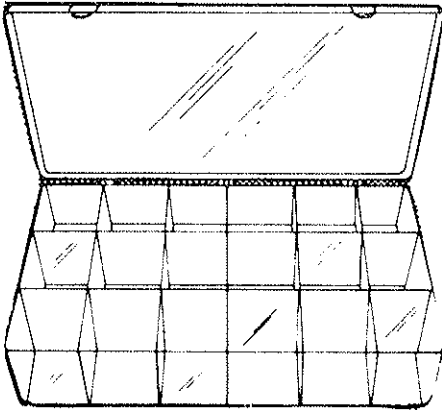

J99011 • SLOTTED SHEET METAL SCREW ASSORTMENT

INCLUDES: 575 pcs. plus 18 Compartment See-Thru Tray

PAN HEAD SLOTTED		
PART#	SIZE	QTY
J77008	6x $\frac{1}{2}$	50
J77010	6x $\frac{3}{4}$	50
J77012	6x1	25
J77020	8x $\frac{1}{4}$	50
J77023	8x $\frac{5}{8}$	50
J77027	8x1 $\frac{1}{4}$	25

OVAL HEAD SLOTTED		
PART#	SIZE	QTY
J77098	6x1	25
J77109	8x1	25
J77110	8x1 $\frac{1}{4}$	25
J77119	10x1 $\frac{1}{4}$	25
J77128	12x1	25
J77138	14x1 $\frac{1}{4}$	25

FLAT HEAD SLOTTED		
PART#	SIZE	QTY
J77166	8x $\frac{3}{4}$	50
J77168	8x1	25
J77175	10x $\frac{1}{2}$	25
J77179	10x1 $\frac{1}{4}$	25
J77191	12x $\frac{3}{4}$	25
J77193	12x1 $\frac{1}{4}$	25

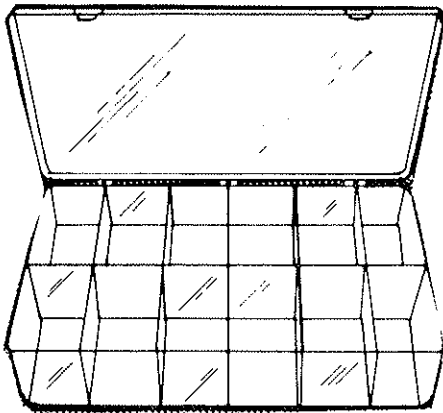
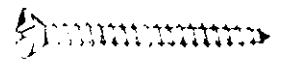
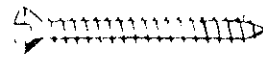
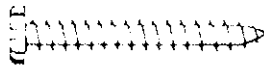

J99012 • PHILLIPS ROUND WASHER HEAD SMS ASSORTMENT (ZINC PLATED AND BLACK OXIDE)

INCLUDES: 500 pcs. and 12 Compartment See-Thru Tray

ZINC PLATED		
PART#	SIZE	QTY
J77485	8x $\frac{7}{16}$	50
J77487	8x $\frac{3}{4}$	50
J77490	8x1 $\frac{1}{2}$	25
J77495	10x $\frac{3}{8}$	50
J77497	10x $\frac{3}{4}$	50
J77499	10x1 $\frac{1}{2}$	25

BLACK OXIDE		
PART#	SIZE	QTY
J77510	8x $\frac{7}{16}$	50
J77512	8x $\frac{3}{4}$	50
J77515	8x1 $\frac{1}{2}$	25
J77520	10x $\frac{3}{8}$	50
J77522	10x $\frac{3}{4}$	50
J77524	10x1 $\frac{1}{2}$	25

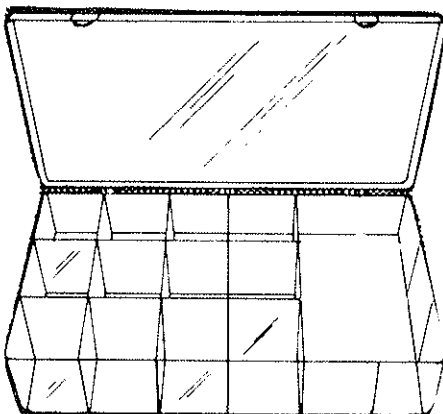
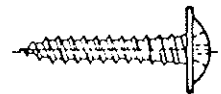

J99013 • ELECTRICAL TERMINAL ASSORTMENT WITH CRIMPING PLIERS

INCLUDES: 275 pcs. plus 13 Compartment See-Thru Tray

PART#	DESCRPT.	CLR./SPEC.	SIZE	QTY.
J88000	Crimp Tool			1 pr.
J88046	Ring Term.	10 stud	16-14	25
J88047	Ring Term.	$\frac{1}{4}$ stud	16-14	25
J88059	Butt Conn.	Red	22-18	25
J88060	Butt Conn.	Blue	16-14	25
J88061	Butt Conn.	Yellow	12-10	20
J88065	Female	.250 Tab	16-14	20
J88067	Male	.157 Snap	16-14	20
J88073	Female	.187 Tab	16-14	25
J88088	Female	.250 Tab	16-14	20
J88089	Male	.250 Tab	16-14	20
J88174	Male	.187 Tab	16-14	25
J88175	Male	.250 Tab	16-14	25

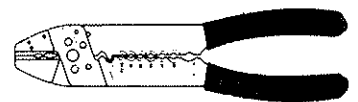

The J88000 is a high quality, compact crimping tool designed to handle six of the most common electrical wiring functions with ease and reliability.

ASSORTMENTS

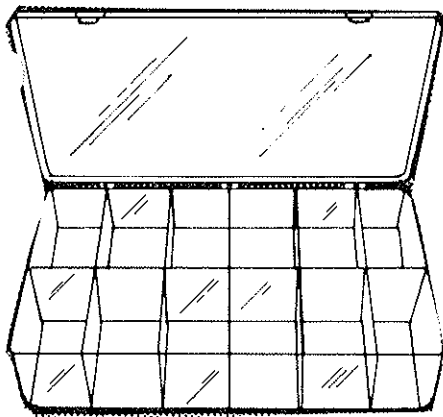

J99014 • COTTER PIN ASSORTMENT

INCLUDES: 920 pcs. plus 12 Compartment See-Thru Tray

PART#	SIZE	QTY	PART#	SIZE	QTY
J43001	1/16x3/4	200	J43025	5/32x1	40
J43003	3/32x1/2	200	J43029	5/32x2	50
J43005	3/32x1	100	J43040	3/16x1 1/2	30
J43010	7/64x3/4	100	J43044	3/16x2 1/2	20
J43016	1/8x1 1/4	80	J43050	1/4x1	10
J43019	1/8x2	80	J43054	1/4x2	10

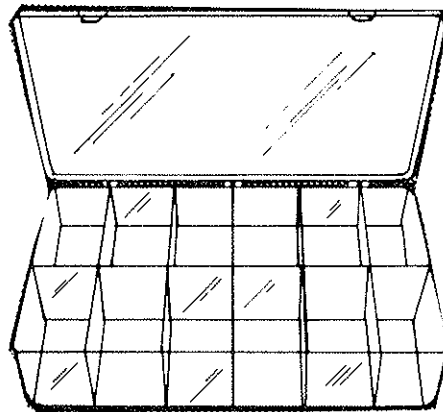

J99015 • SLOTTED HEX WASHER HEAD SMS ASSORTMENT

INCLUDES: 625 pcs. plus 12 Compartment See-Thru Tray

PART#	SIZE	QTY	PART#	SIZE	QTY
J77625	#8x3/8	100	J77638	#10x3/4	50
J77626	#8x1/2	100	J77639	#10x1	50
J77627	#8x5/8	50	J77650	#12x3/4	50
J77628	#8x3/4	50	J77651	#12x1	25
J77629	#8x1	50	J77667	#14x1	25
J77636	#10x1/2	50	J77668	#14x1 1/4	25

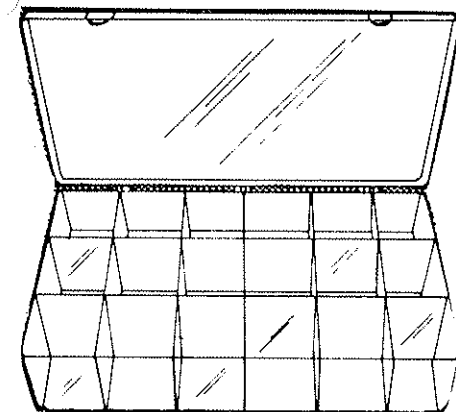
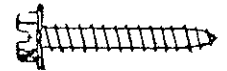

J99016 • SLOTTED MACHINE SCREWS W/ROUND HEAD

INCLUDES: 1,000 pcs. and 18 Compartment See-Thru Tray

PART#	SIZE	QTY	PART#	SIZE	QTY
J31015	#6-32x1/4	50	J31037	#8-32x1 1/4	25
J31017	#6-32x1/2	50	J31039	#8-32x1 3/4	25
J31019	#6-32x3/4	50	J31144	#8-32 nut	100
J31020	#6-32x1	50	J31060	#10-32x1/4	50
J31022	#6-32x1 1/2	25	J31062	#10-32x1/2	50
J31143	#6-32 nut	150	J31064	#10-32x3/4	50
J31031	#8-32x3/8	50	J31065	#10-32x1	50
J31033	#8-32x5/8	50	J31067	#10-32x1 1/2	25
J31035	#8-32x7/8	50	J31146	#10-32 nut	100

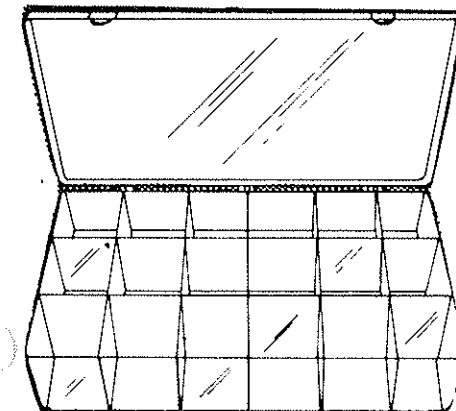
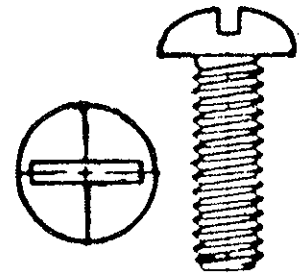

J99017 • SLOTTED MACHINE SCREWS W/FLAT HEAD

INCLUDES: 1,025 pcs. plus 18 Compartment See-Thru Tray

PART#	SIZE	QTY	PART#	SIZE	QTY
J31165	#6-32x1/4	50	J31185	#8-32x1	50
J31166	#6-32x3/8	50	J31187	#8-32x1 1/2	25
J31167	#6-32x1/2	50	J31144	#8-32 nut	100
J31168	#6-32x5/8	50	J31210	#10-32x1/4	50
J31169	#6-32x3/4	50	J31212	#10-32x1/2	50
J31143	#6-32 nut	150	J31214	#10-32x1	50
J31180	#8-32x1/4	50	J31215	#10-32x1 1/4	25
J31182	#8-32x1/2	50	J31216	#10-32x1 1/2	25
J31184	#8-32x3/4	50	J31146	#10-32 nut	100

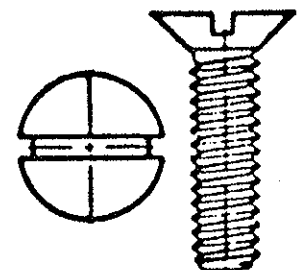

ASSORTMENTS

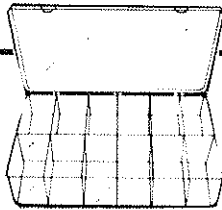

J99018 • POP RIVET ASSORTMENT

INCLUDES: 495 pcs. plus 12 Compartment See-Thru Tray

J40112 (SB4-2) 1/8" Dia. Buttonhead Rivet Grip Range 1/16 to 1/8 Hole Dia. .129-.133 (#30 Drill) Plated Steel Rivet-Steel Mandrel 50 pcs.	J40115 (SB4-3) 1/8" Dia. Buttonhead Rivet Grip Range 1/8 to 3/16 Hole Dia. .129-.133 (#30 Drill) Plated Steel Rivet-Steel Mandrel 50 pcs.	J40117 (SB4-4) 1/8" Dia. Buttonhead Rivet Grip Range 3/16 to Hole Dia. .129-(#30 Drill) Plated Steel Rivet-Steel Mandrel 50 pcs.	J40212 (AB4-2A) 1/8" Dia. Buttonhead Rivet Grip Range 1/16 to 1/8 Hole Dia. .129-.133 (#30 Drill) Alum. Rivet & Mandrel 50 pcs.
J40215 (AB4-3A) 1/8" Dia. Buttonhead Rivet Grip Range 1/8 to 3/16 Hole Dia. .129-.133 (#30 Drill) Alum. Rivet & Mandrel 50 pcs.	J40216 (AC4-3A) 1/8" Dia. Countersunk Rivet Grip Range 1/8 to 3/16 Hole Dia. .129-.133 (#30 Drill) Alum. Rivet & Alum. Mandrel 50 pcs.	J40217 (AB4-4A) 1/8" Dia. Buttonhead Rivet Grip Range 3/16 to 1/4 Hole Dia. .129-.133 (#30 Drill) Alum. Rivet & Mandrel 50 pcs.	J40261 (ABN-4-3A) Molding Clip Rivet 1/8 Dia. use 1/8 Drill Alum. Rivet & Alum. Mandrel 50 pcs.
J40237 (AB5-8A) 5/32 Dia. Buttonhead Rivet Grip Range 3/8 to 1/2 Hole Dia. .160-.164 (#20 Drill) Alum. Rivet & Alum. Mandrel 25 pcs.	J40245 (AB5-2) 3/16 Dia. Buttonhead Rivet Grip Range up to 1/8 Hole Dia. .192-.196 (#11 Drill) Alum. Rivet & Alum. Mandrel. 25 pcs.	J40347 (AB6-4) 3/16 Dia. Buttonhead Rivet Grip Range 1/8 to 1/4 Hole Dia. .192-.196 (#11 Drill) Alum. Rivet & Steel Mandrel 25 pcs.	J40350 (ABL6-6) 3/16 Dia. Lg. Flange Rivet Grip Range up to 3/8 Hole Dia. .192-.196 (#11 Drill) Alum. Rivet & Steel Mandrel 20 pcs.

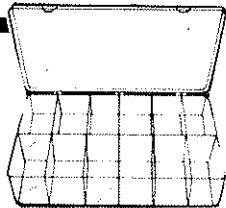

J99019 • HOSE & TUBING CONNECTOR ASSORTMENT

INCLUDES: 105 pcs. and 12 Compartment See-Thru Tray

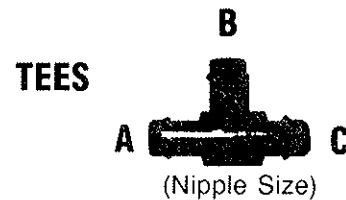

Part No.	A	B	C	
J81210	1/8	1/8	1/8	10 pcs.
J81211	3/16	3/16	3/16	10 pcs.
J81212	1/4	1/4	1/4	10 pcs.
J81213	5/16	5/16	5/16	10 pcs.
J81214	3/8	3/8	3/8	5 pcs.
J81215	1/8	3/16	1/8	10 pcs.
J81216	3/16	1/8	3/16	10 pcs.
J81217	3/16	1/4	3/16	10 pcs.



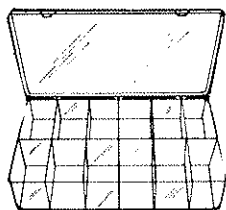

Part No.	A	B	C	
J81218	3/16	3/16	1/8	10 pcs.
J81219	1/4	3/16	3/16	10 pcs.
J81220	3/8	1/4	3/8	5 pcs.
J81221	3/8	3/8	1/4	5 pcs.

ASSORTMENTS



J99020 • RESTRICTOR & TEE CONNECTOR ASSORTMENT

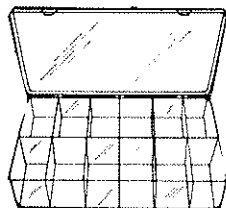

INCLUDES: 110 pcs. plus 12 Compartment See-Thru Tray

	Part No.	A	B	C		
TEE	J81222	3/8	1/4	3/8	5 pcs.	
FOUR-WAY TEE	J81223	3/16			10 pcs.	 All Ends
FIVE-WAY TEE	J81224	3/16			5 pcs.	 All Ends
CONNECTORS	J81230	1/8	1/8		10 pcs.	
	J81231	3/16	3/16		10 pcs.	
	J81232	1/4	1/4		10 pcs.	
	J81233	5/16	5/16		10 pcs.	
	J81234	3/8	3/8		10 pcs.	
	J81235	1/8	3/16		10 pcs.	
	J81236	1/8	1/4		10 pcs.	
	J81237	3/16	1/4		10 pcs.	
	J81238	3/16	3/16		10 pcs.	



J99021 • ELBOW, WYE & VACUUM LINE CAP ASSORTMENT

INCLUDES: 100 pcs. plus 12 Compartment See-Thru Tray

	Part No.	A	B	C		
WYE	J81240	3/16	3/16	3/16	10 pcs.	
	J81241	1/4	1/4	1/4	10 pcs.	
	J81242	5/16	5/16	5/16	5 pcs.	
	J81243	1/4	1/4	3/16	10 pcs.	
	J81244	1/4	3/8	3/8	5 pcs.	
ELBOWS	J81250	3/16	3/16		10 pcs.	
	J81251	1/4	1/4		10 pcs.	
	J81252	1/8	3/16		10 pcs.	
	J81253	3/16	1/4		10 pcs.	
VACUUM LINE CAP-RUBBER	J81260		3/16		10 pcs.	
	J81261		1/4		10 pcs.	

ASSORTMENTS

J99022 • TORX® STAINLESS STEEL TRIM SCREW ASSORTMENT

INCLUDES: 300 pcs. plus 12 Compartment See-Thru Tray

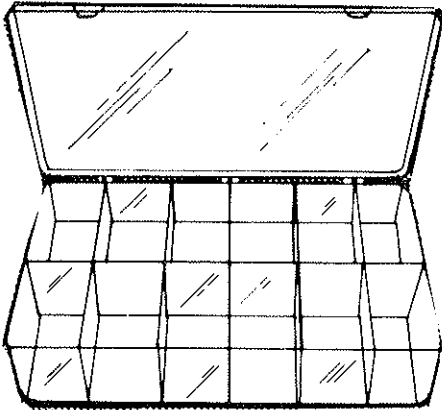

PART#	METRIC SIZE	GM PART#	FINISH	HEAD	QTY
J795032	4.2 x 16	11504550	chrome	oval	25
J795033	4.2 x 16	11504660	black	oval	25
J795034	4.2 x 20	11504069	chrome	oval	25
J795035	4.2 x 20	11504659	black	oval	25
J795036	4.2 x 25	11504551	chrome	oval	25
J795037	4.2 x 30	11504522	chrome	oval	25
J795038	4.2 x 30	11504656	black	oval	25
J795044	4.2 x 20*	11504478	black	oval	25
J795046	4.2 x 20	11504655	black	pan	25
J795047	4.2 x 25	11504661	chrome	pan	25
J795048	4.2 x 25	11504662	black	pan	25
J795049	4.2 x 35	11504663	chrome	pan	25

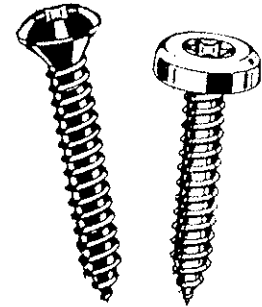

* denotes standard oval head

J99060 • BRAKE BLEEDER SCREW ASSORTMENT

INCLUDES: 56 pcs. plus 12 Compartment See-Thru Tray

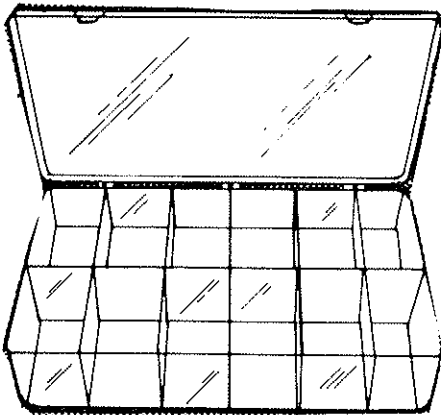

PART#	SIZE	QTY
J075143	3/8-24x1.360	10
J075144	3/8-24x1.471	10
J075145	3/8-24x1.11	10
J075146	5/16-24x1.060	10
J075147	1/4-28x.920	10
J075148	repair inserts	6

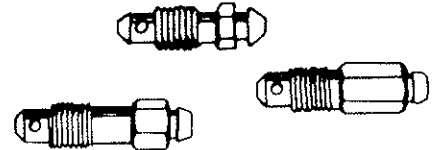

J99070 • BI-ARC DRILL SCREW ASSORTMENT

INCLUDES: 300 pcs. and 12 Compartment See-Thru Tray

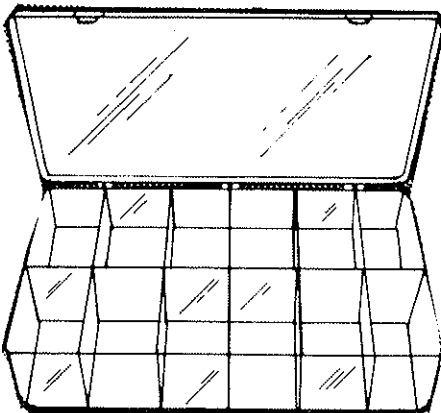

PART#	SIZE & DESCRIPTION	QTY
J77722	#8x1/2 w/Hex Washer Head, No Slot	25
J77723	#8x5/8 w/Hex Washer Head, No Slot	25
J77724	#8x3/4 w/Hex Washer Head, No Slot	25
J77726	#8x1 w/Hex Washer Head, No Slot	25
J77736	#10x1/2 w/Hex Washer Head, No Slot	25
J77737	#10x5/8 w/Hex Washer Head, No Slot	25
J77738	#10x3/4 w/Hex Washer Head, No Slot	25
J77739	#10x1 w/Hex Washer Head, No Slot	25
J77757	#12x3/4 w/Hex Washer Head, No Slot	25
J77759	#12x1 w/Hex Washer Head, No Slot	25
J77822	#8x1/2 w/Phillips Pan Head	25
J77824	#8x3/4 w/Phillips Pan Head	25

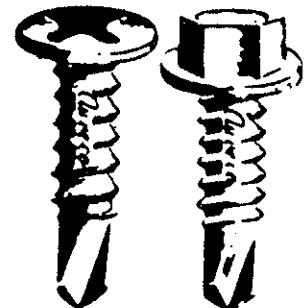

ASSORTMENTS

TENSION (ROLL) PIN ASSORTMENT

10 pcs - $\frac{1}{16}$ X $\frac{1}{2}$
10 pcs - $\frac{5}{64}$ X $\frac{1}{2}$
10 pcs - $\frac{3}{32}$ X $\frac{3}{4}$
10 pcs - $\frac{3}{32}$ X 1
10 pcs - $\frac{1}{8}$ X $\frac{3}{4}$
10 pcs - $\frac{1}{8}$ X 1

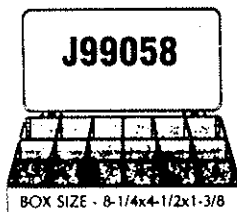

10 pcs - $\frac{1}{8}$ X $1\frac{1}{2}$
10 pcs - $\frac{5}{32}$ X 1
10 pcs - $\frac{5}{32}$ X $1\frac{1}{2}$
10 pcs - $\frac{3}{16}$ X 1
10 pcs - $\frac{3}{16}$ X $1\frac{1}{2}$
10 pcs - $\frac{1}{4}$ X 2

GREASE FITTING ASSORTMENT

10 pcs each

T610PK $\frac{1}{8}$ NPT STR
T613PK $\frac{1}{8}$ NPT 90°
T637PK $\frac{1}{4}$ -28 45°
T641PK $\frac{1}{4}$ -28 STR

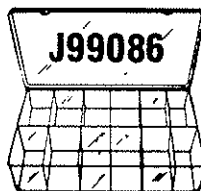

T9001PK 6mm Engine STR
T9041PK 6mm 45°
T9061PK 6mm 90°
T911PK $\frac{1}{4}$ -28 90°

PARTS ALSO SOLD SEPARATELY
10 PER PACK

VACUUM CONNECTORS - EMISSION HARNESS HEAT & CHEMICAL RESISTANT RUBBER

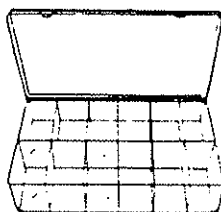

J88-6455
J88-6456
J88-6457
J88-6458
J88-6459
J88-6460
J88-6461
J88-6462

J99085 EMISSION CONNECTOR ASSORTMENT

Includes: 5 pieces of each connector
plus 12 compartment see-thru tray.

A-C O-RING ASSORTMENT J99090

10 Pieces Each



J81400 BLEED, EQUALIZER, CAPILLARY TUBE
J81401 #6 HOSE FITTING
J81402 #8 HOSE FITTING
J81403 #10 HOSE FITTING
J81404 #12 HOSE FITTING
J81405 #6 GM/COMB. VALVE EVAP PORT
J81406 #8 GM O-RING
J81407 #12 GM O-RING
J81408 SUCTION FITTING
J81409 SUCTION/DISCHARGE PORT

ASSORTMENTS

J99061 HAIRPIN RETAINER ASSORTMENT

INCLUDES: 550 pcs. plus 12 Compartment See-Thru Tray

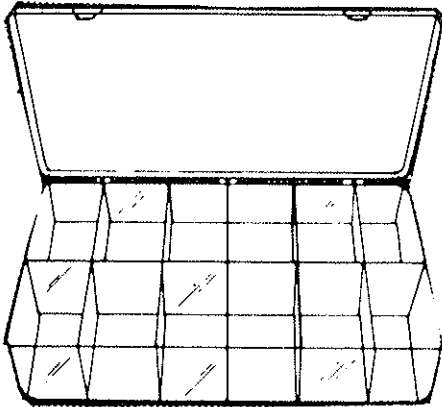

PART#	SIZE
J9000	3/64 groove
J9001	1/16 groove
J9002	1/8 groove
J9003	3/16 groove
J9005	7/32 groove
J9006	1/4 groove
J9015	5/16 groove
J9007	3/8 groove
J9008	7/16 groove
J9009	1/2 groove
J9010	9/16 groove
J9011	5/8 groove

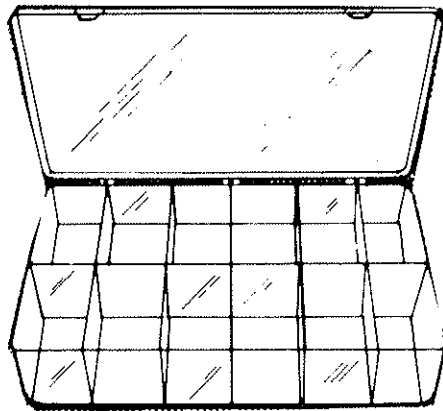

J99062 • "E" RING ASSORTMENT

INCLUDES: 600 pcs. plus 12 Compartment See-Thru Tray

J9100	1/16 shaft	J9106	7/32 shaft
J9101	3/32 shaft	J9107	1/4 shaft
J9102	1/8 shaft	J9108	5/16 shaft
J9103	9/64 shaft	J9109	3/8 shaft
J9104	5/32 shaft	J9110	7/16 shaft
J9105	3/16 shaft	J9111	1/2 shaft

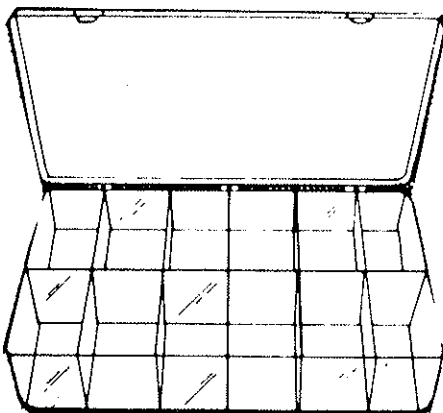

J99064 PUSHNUT RETAINER ASSORTMENT

INCLUDES: 600 pcs. plus 12 Compartment See-Thru Tray

Detent Washer (Round Speed Nut)

J9252	1/8 stud	Push Nut Retainer	
J9253	5/32 stud	J9265	1/4 bolt size
J9254	3/16 stud	J9266	5/16 bolt size
J9257	1/4 stud	J9267	3/8 bolt size
J9258	5/16 stud	J9268	7/16 bolt size
J9259	3/8 stud	J9269	1/2 bolt size
J9261	1/2 stud		



ASSORTMENTS

J99001 • PHILLIPS ROUND WASHER HEAD ASSORTMENT

INCLUDES: 1,850 pcs. plus 16 Compartment Storage Drawer

PART#	SIZE	DESC.	QTY
J77485	8x7/16	zinc	125
J77487	8x3/4	zinc	100
J77488	8x1	zinc	75
J77490	8x1 1/2	zinc	75
J77496	10x1/2	zinc	175
J77497	10x3/4	zinc	150
J77498	10x1	zinc	125
J77499	10x1 1/2	zinc	100
J77510	8x7/16	black	150
J77511	8x1 1/2	black	125
J77513	8x1	black	100
J77515	8x1 1/2	black	75
J77521	10x1/2	black	150
J77522	10x3/4	black	125
J77523	10x1	black	100
J77524	10x1 1/2	black	100

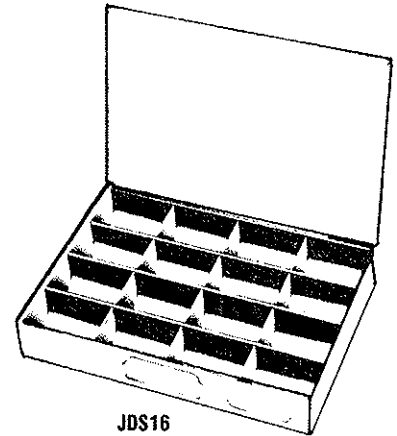
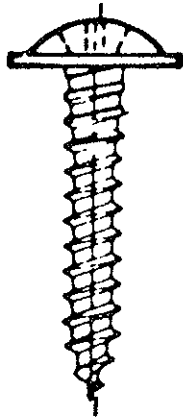

JDS16
13 5/16" x 9 1/4" x 2"

J99075 • TORX® STAINLESS STEEL TRIM SCREW ASSORTMENT

INCLUDES: 600 pcs. plus 12 Compartment Storage Drawer

PART#	METRIC SIZE	GM PART#	FINISH	HEAD	QTY
J795032	4.2 x 16	11504550	chrome	oval	50
J795033	4.2 x 16	11504660	black	oval	50
J795034	4.2 x 20	11504069	chrome	oval	50
J795035	4.2 x 20	11504659	black	oval	50
J795036	4.2 x 25	11504551	chrome	oval	50
J795037	4.2 x 30	11504522	chrome	oval	50
J795038	4.2 x 30	11504656	black	oval	50
J795044	4.2 x 20*	11504478	black	oval	50
J795046	4.2 x 20	11504655	black	pan	50
J795047	4.2 x 25	11504661	chrome	pan	50
J795048	4.2 x 25	11504662	black	pan	50
J795049	4.2 x 35	11504663	chrome	pan	50

* denotes standard oval head

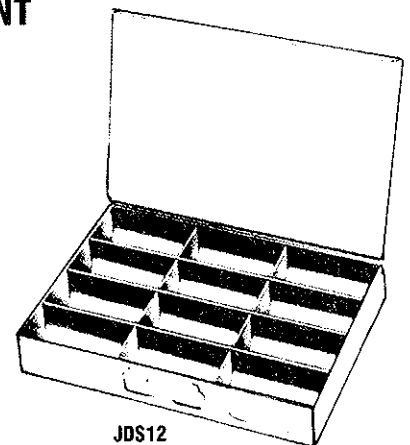
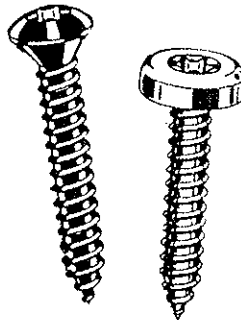

JDS12
13 5/16" x 9 1/4" x 2"

Storage Drawer Racks

Racks available to hold four (4) drawers, either large or small size. (Extra drawers are also available—see Section 1/Page 3.)

4LR Large Rack
4SR Small Rack

Cabinet will not tilt even with fully loaded drawers in open position.

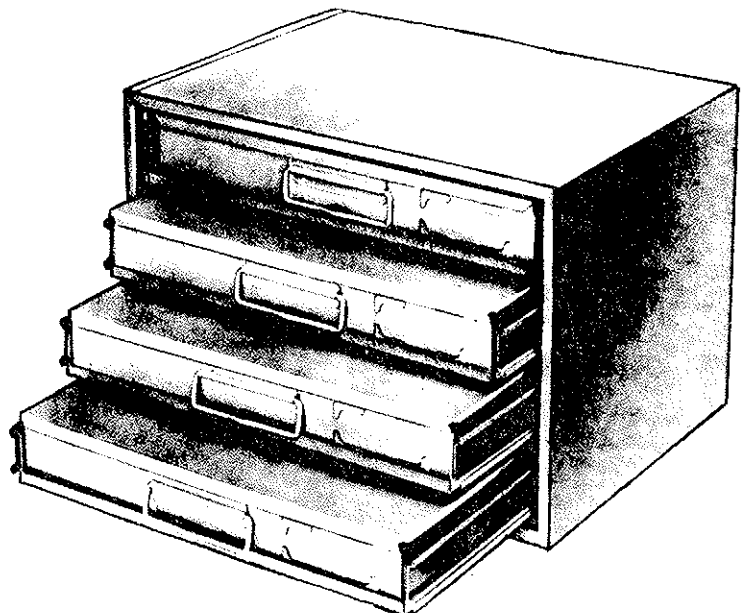

ASSORTMENTS



J99036DS • TERMINAL ASSORTMENT

INCLUDES: 975 pcs. plus Crimping Tool & Sm. 21-Compartment Pull-Out Drawer

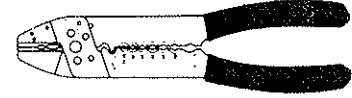

JDS-21 13⁵/₁₆x9¹/₄x2

PART#	DESCRIPTION	SIZE	QTY	PART#	DESCRIPTION	SIZE	QTY
J6123	Yellow Scotchlok	12-10 to 12-10	15	J88042	Ring Terminal	22-18 10-stud	50
J6127	Blue Scotchlok	18-14 to 18-14	25	J88088	Female	16-14 .250-tab	50
J6129	Red Scotchlok	22-18 to 18-14	25	J88176	Male	12-10 .250-tab	50
J88319	Fuse Holder		10	J88175	Male	16-14 .250-tab	50
J88061	Yellow Butt Connector	12-10	50	J88173	Male	22-18 .250-tab	50
J88060	Blue Butt Connector	18-14	100	J88067	Male	16-14 .157-snap	50
J88059	Red Butt Connector	22-18	100	J88066	Female	12-10 .250-tab	50
J88089	Male	16-14 .250-tab	50	J88065	Female	16-14 .250-tab	50
J88051	Ring Terminal	12-10 ¼-stud	50	J88062	Female	22-18 .250-tab	50
J88045	Ring Terminal	16-14 8-stud	50	J88085	Female	16-14 .157-snap	50

Heavy duty storage drawers manufactured of prime cold rolled steel finished in baked enamel. All scoop drawers have sloped front and back compartments for easy removal of parts. Racks available to hold four drawers, either large or small size.

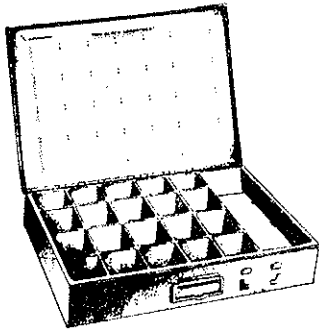

J99035DL • TERMINAL ASSORTMENT

INCLUDES: 985 pcs. plus Crimping Tool & Lg. 21-Compartment Pull-Out Drawer

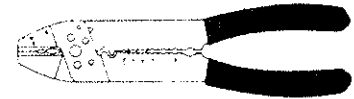

JDL-21 18x12x3

PART#	DESCRIPTION	SIZE	QTY	PART#	DESCRIPTION	SIZE	QTY
J6123	Yellow Scotchlok	12-10 to 12-10	25	J88042	Ring Terminal	22-18 10-stud	50
J6127	Blue Scotchlok	18-14 to 18-14	25	J88088	Female	16-14 .250-tab	50
J6129	Red Scotchlok	22-18 to 18-14	25	J88176	Male	12-10 .250-tab	50
J88319	Fuse Holder		10	J88175	Male	16-14 .250-tab	50
J88061	Yellow Butt Connector	12-10	50	J88173	Male	22-18 .250-tab	50
J88060	Blue Butt Connector	18-14	100	J88067	Male	16-14 .157-snap	50
J88059	Red Butt Connector	22-18	100	J88066	Female	12-10 .250-tab	50
J88089	Male	16-14 .250-tab	50	J88065	Female	16-14 .250-tab	50
J88051	Ring Terminal	12-10 ¼-stud	50	J88062	Female	22-18 .250-tab	50
J88045	Ring Terminal	16-14 8-stud	50	J88085	Female	16-14 .157-snap	50

J835727 • NYLON BLIND RIVET ASSORTMENT

—Contains—

20 each J835642	15 each J835646	15 each J835650
20 each J835643	15 each J835647	10 each J835664
20 each J835644	15 each J835648	
20 each J835645	15 each J835649	

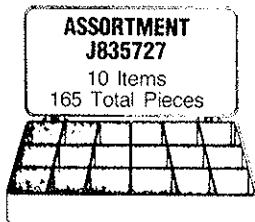

ASSORTMENTS

STANDARD METRIC ASSORTMENT

- J99023DL** • 840 pcs. plus two (JDL)
24-Compartment Storage Drawers
- J99024DS** • 840 pcs. plus two (JDS)
24-Compartment Storage Drawers

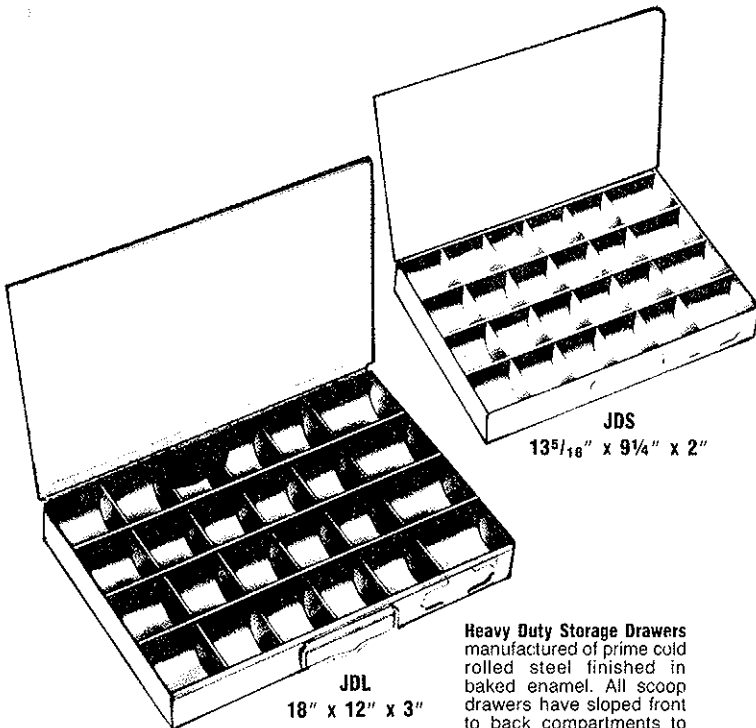

Heavy Duty Storage Drawers manufactured of prime cold rolled steel finished in baked enamel. All scoop drawers have sloped front to back compartments to removal of parts easy.

JDL
18" x 12" x 3"

PART#	SIZE	QUANTITY		PART#	SIZE	QUANTITY	
		23DL	24DS			23DL	24DL
J65300	M4x10	20	20	J65382	M10x45	5	5
J65301	M4x12	20	20	J65403	M12x20	5	5
J65302	M4x16	20	20	J65404	M12x25	5	5
J65304	M4x25	10	10	J65405	M12x30	5	5
J65305	M4x35	10	10	J65407	M12x40	5	5
J65314	M5x10	20	20	J65408	M12x45	5	5
J65316	M5x16	20	20	J65591	M4 nut	20	20
J65317	M5x20	20	20	J65592	M5 nut	20	20
J65319	M5x30	10	10	J65593	M6 nut	20	20
J65321	M5x40	10	10	J65594	M8 nut	20	20
J65331	M6x12	20	20	J65595	M10 nut	20	20
J65332	M6x16	20	20	J65596	M12 nut	20	20
J65333	M6x20	20	20	J65661	M4 flat	50	50
J65334	M6x25	10	10	J65662	M5 flat	50	50
J65336	M6x35	10	10	J65663	M6 flat	50	50
J65352	M8x12	10	10	J65664	M8 flat	50	50
J65354	M8x20	10	10	J65665	M10 flat	20	20
J65356	M8x30	10	10	J65666	M12 flat	20	20
J65357	M8x35	10	10	J65674	M4 L/W	25	25
J65359	M8x45	10	10	J65675	M5 L/W	25	25
J65377	M10x20	5	5	J65676	M6 L/W	25	25
J65378	M10x25	5	5	J65677	M8 L/W	25	25
J65379	M10x30	5	5	J65678	M10 L/W	20	20
J65381	M10x40	5	5	J65679	M12 L/W	20	20

PLASTIC CONNECTOR ASSORTMENT

- J99051DL** • 240 pcs. plus one (JDL)
24-Compartment Storage Drawers
- J99052DS** • 210 pcs. plus one (JDS)
24-Compartment Storage Drawers

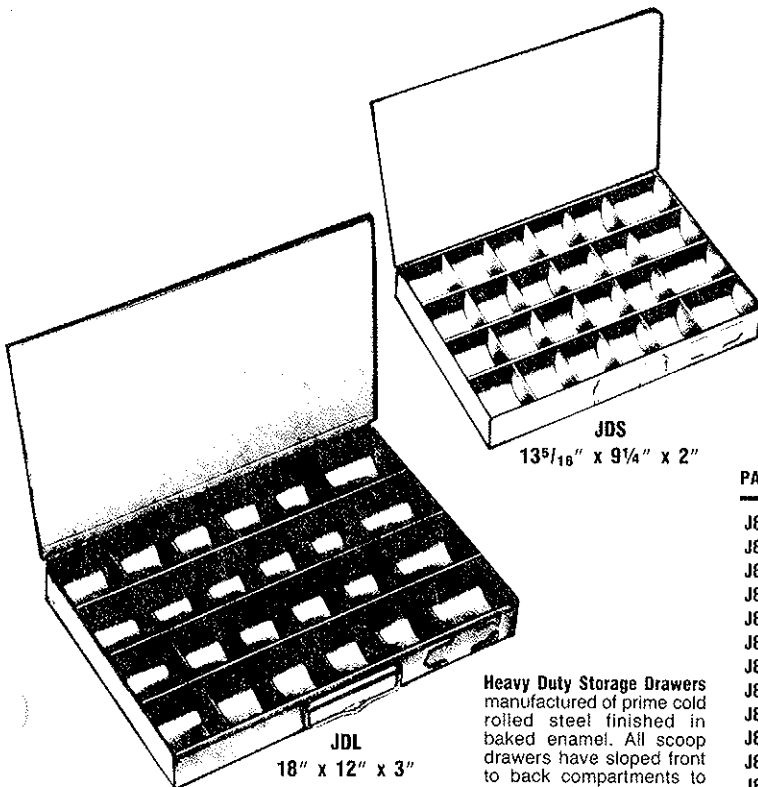

Heavy Duty Storage Drawers manufactured of prime cold rolled steel finished in baked enamel. All scoop drawers have sloped front to back compartments to removal of parts easy.

JDL
18" x 12" x 3"

PART#	SIZE	QUANTITY		PART#	SIZE	QUANTITY	
		51DL	52DS			51DL	52DL
J81210	1/8x1/8x1/8 T	10	10	J81232	1/4x1/4 C	10	10
J81211	3/16x3/16x3/16 T	10	10	J81233	5/16x5/16 C	10	10
J81212	1/4x1/4x1/4 T	10	8	J81235	1/8x3/16 C	10	10
J81215	3/16x3/16x1/8 T	10	10	J81236	1/8x1/4 C	10	10
J81216	3/16x1/8x3/16 T	10	10	J81237	3/16x1/4 C	10	10
J81214	3/8x3/8x3/8 T	10	5	J81222	3/8x1/4x3/8 T	10	5
J81217	3/16x1/4x3/16 T	10	10	J81238	3/16x3/16 R/C	10	10
J81218	3/16x3/16x1/8 T	10	10	J81240	3/16x3/16x3/16 Y	10	7
J81223	3/16 4-way T	10	7	J81243	1/4x1/4x3/16 Y	10	7
J81230	1/8x1/8 C	10	10	J81250	3/16x3/16 L	10	10
J81231	3/16x3/16 C	10	10	J81252	1/8x3/16 L	10	10
J81221	3/8x3/8x1/4 T	10	6	J81224	3/16 5-way T	10	5

ASSORTMENTS

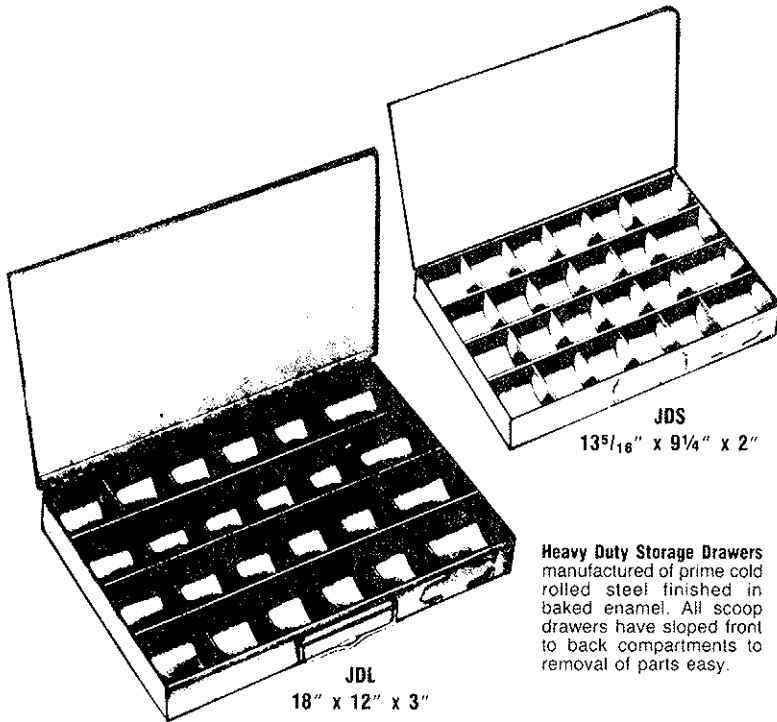

Heavy Duty Storage Drawers manufactured of prime cold rolled steel finished in baked enamel. All scoop drawers have sloped front to back compartments to removal of parts easy.

TRIM SCREW ASSORTMENT

- J99053DL** • 2,400 pcs. plus one (JDL)
24-Compartment Storage Drawers
- J99054DS** • 1,200 pcs. plus one (JDS)
24-Compartment Storage Drawers

PART#	SIZE	DESCRIPTION	PLT.	QUANTITY	
				53DL	54DS
J2692	8 x 3/8	phillips flat	black	100	50
J2688	8 x 1/2	phillips flat	black	100	50
J2697	8 x 3/4	phillips pan	black	100	50
J733884	8 x 3/4	#6 hd. phillips oval	chrome	100	50
J733885	8 x 1	#6 hd. phillips oval	chrome	100	50
J733888	8 x 1/2	phillips oval	chrome	100	50
J733889	10 x 3/4	#8 hd. phillips oval	chrome	100	50
J733908	8 x 1/2	phillips oval hd./washer hd.	zinc	100	50
J733892	10 x 1 1/2	#8 hd. phillips oval	chrome	100	50
J733808	8 x 3/4	phillips oval w/cntrsnsk	chrome	100	50
J733810	8 x 1 1/4	phillips oval w/cntrsnsk	chrome	100	50
J733448	8 x 1	hex hd. w/washer	black	100	50
J733861	8 x 3/4	phillips oval hd.	black	100	50
J733864	8 x 1 1/2	phillips oval	black	100	50
J733867	8 x 3/4	#6 hd. phillips oval	black	100	50
J733868	8 x 1	#6 hd. phillips oval	black	100	50
J733870	8 x 1 1/2	#6 hd. phillips oval	black	100	50
J733873	10 x 1	phillips oval	black	100	50
J733874	10 x 1 1/2	phillips oval	black	100	50
J733876	10 x 3/4	#8 hd. phillips oval	black	100	50
J733877	10 x 1	#8 hd. phillips oval	black	100	50
J733878	10 x 1 1/2	#8 hd. phillips oval	black	100	50
J733913	8 x 1	phillips oval/washer hd.	black	100	50
J733914	8 x 1	phillips oval/washer hd.	black	100	50

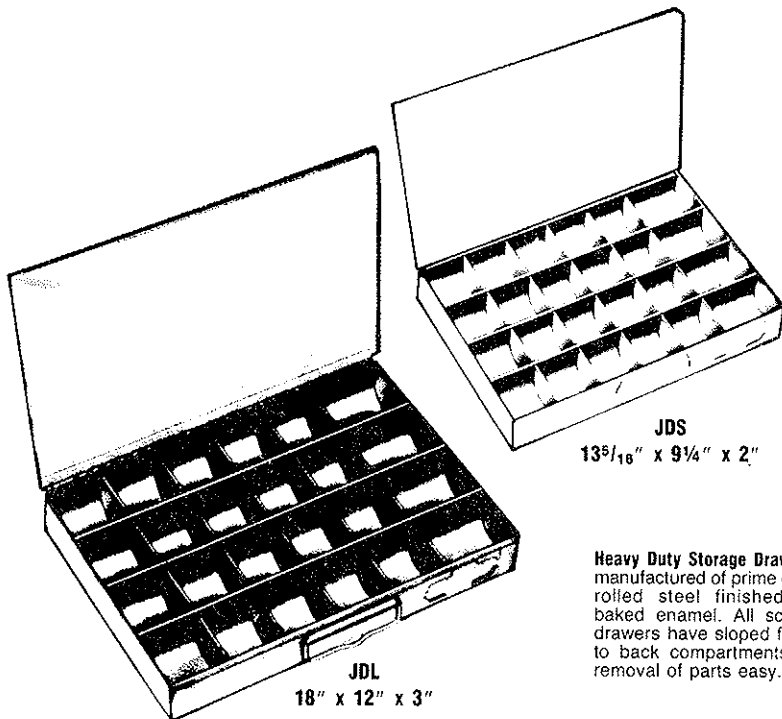

Heavy Duty Storage Drawers manufactured of prime cold rolled steel finished in baked enamel. All scoop drawers have sloped front to back compartments to removal of parts easy.

SMALL HEAD METRIC ASSORTMENT

- J99041DL** • 490 pcs. plus one (JDL)
24-Compartment Storage Drawer
- J99040DS** • 355 pcs. plus one (JDS)
24-Compartment Storage Drawer

PART#	SIZE	QUANTITY		PART#	SIZE	QUANTITY	
		DS	DL			DS	DL
J66131	M8x16	10	20	J66173	M12x40	5	10
J66133	M8x20	10	20	J66174	M12x50	5	10
J66134	M8x25	10	20	J66175	M12x60	5	5
J66135	M8x30	10	20	J66200	M8 hex nut	20	30
J66137	M8x40	10	10	J66201	M10 hex nut	20	30
J66141	M8x60	10	10	J66202	M12 hex nut	20	30
J66151	M10x20	5	10	J65664	M8 flat washer	50	50
J66153	M10x30	5	10	J65665	M10 flat washer	30	30
J66155	M10x40	5	10	J65666	M12 flat washer	30	30
J66157	M10x50	5	10	J65677	M8 lock washer	50	50
J66159	M10x60	5	5	J65678	M10 lock washer	30	30
J66172	M12x30	5	10				

ASSORTMENTS

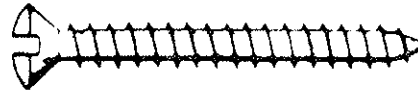

J99005 • SLOTTED OVAL HEAD SMS ASSORTMENT

INCLUDES: 4,475 pcs. plus 40 Bin Cabinet

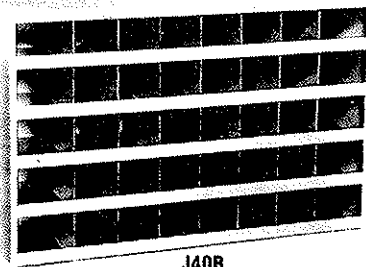

J40B
35 1/4" x 24" x 12"

HEAVY DUTY pigeon hole type storage bins produced of heavy gauge steel and finished in rust and acid resistant baked enamel will not warp, twist, or sag out of alignment.

PART#	SIZE	QTY	PART#	SIZE	QTY	PART#	SIZE	QTY
J77095	6 x 1/2	375	J77115	10 x 1/2	300	J77128	12 x 1	200
J77097	6 x 3/4	300	J77117	10 x 3/4	250	J77129	12 x 1 1/4	150
J77098	6 x 1	200	J77118	10 x 1	200	J77130	12 x 1 1/2	100
J77105	8 x 1/2	300	J77119	10 x 1 1/4	150	J77135	14 x 3/4	275
J77107	8 x 3/4	250	J77120	10 x 1 1/2	100	J77137	14 x 1	175
J77109	8 x 1	200	J77125	12 x 1/2	300	J77139	14 x 1 1/2	125
J77110	8 x 1 1/4	150	J77126	12 x 3/4	250	J77140	14 x 2	125

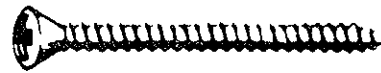

J99006 • PHILLIPS OVAL HEAD SMS ASSORTMENT

INCLUDES: 3,775 pcs. plus 40 Bin Cabinet

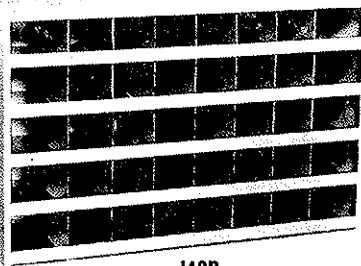

J40B
35 1/4" x 24" x 12"

HEAVY DUTY pigeon hole type storage bins produced of heavy gauge steel and finished in rust and acid resistant baked enamel will not warp, twist, or sag out of alignment.

PART#	SIZE	QTY	PART#	SIZE	QTY	PART#	SIZE	QTY
J77371	6 x 3/8	250	J77403	8 x 5/8	200	J77437	10-#8hdx1 1/2	50
J77372	6 x 1/2	200	J77404	8 x 3/4	150	J77445	10 x 1/2	200
J77373	6 x 5/8	150	J77406	8 x 1	100	J77447	10 x 3/4	150
J77374	6 x 3/4	100	J77407	8 x 1 1/4	50	J77449	10 x 1	100
J77377	6 x 1 1/4	50	J77416	10-#6hdx3/4	200	J77450	10 x 1 1/4	75
J77387	8-#6hdx1/2	200	J77418	10-#6hdx1	150	J77451	10 x 1 1/2	50
J77390	8-#6hdx 7/8	150	J77419	10-#6hdx1 1/2	100	J77453	10 x 2	25
J77391	8-#6hdx 1	100	J77421	10-#6hdx1 3/4	50	J77461	12-#8hdx3/4	75
J77393	8-#6hdx1 1/2	50	J77431	10-#8hdx5/8	200	J77462	12-#8hdx1 1/4	50
J77395	8-#6hdx2	50	J77433	10-#8hdx1	150	J77463	12-#8hdx2	50
J77401	8 x 3/8	250	J77435	10-#8hdx1 1/2	100			



J99007 • SLOTTED FLAT HEAD SMS ASSORTMENT

INCLUDES: 4,450 pcs. plus 40 Bin Cabinet

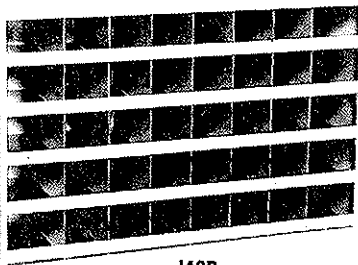

J40B
35 1/4" x 24" x 12"

HEAVY DUTY pigeon hole type storage bins produced of heavy gauge steel and finished in rust and acid resistant baked enamel will not warp, twist, or sag out of alignment.

PART#	SIZE	QTY	PART#	SIZE	QTY	PART#	SIZE	QTY
J77165	8 x 1/2	250	J77178	10 x 1	225	J77194	12 x 1 1/2	150
J77166	8 x 3/4	250	J77179	10 x 1 1/4	200	J77201	14 x 3/4	300
J77167	8 x 7/8	250	J77180	10 x 1 1/2	150	J77202	14 x 1	250
J77168	8 x 1	150	J77181	10 x 2	125	J77203	14 x 1 1/4	225
J77175	10 x 1/2	300	J77191	12 x 3/4	300	J77205	14 x 2	150
J77176	10 x 3/4	300	J77192	12 x 1	300	J77206	14 x 2 1/2	100
J77177	10 x 7/8	250	J77193	12 x 1 1/4	175			

ASSORTMENTS

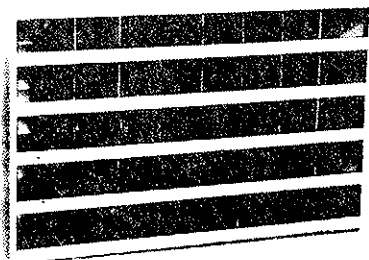
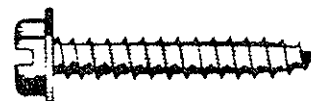
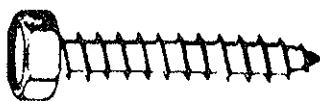

J40B
35 1/4" x 24" x 12"

HEAVY DUTY pigeon hole type storage bins produced of heavy gauge steel and finished in rust and acid resistant baked enamel will not warp, twist, or sag out of alignment.

J99008 • HEX HD. & SLOTTED HEX WASHER HD. ASSORTMENT

INCLUDES: 3,600 pcs. plus 40 Bin Cabinet

PART#	SIZE	QTY	PART#	SIZE	QTY	PART#	SIZE	QTY
J77550*	8 x 3/8	150	J77582*	14 x 3/4	75	J77630**	8 x 1 1/4	100
J77552*	8 x 3/4	125	J77583*	14 x 1	50	J77636**	10 x 1/2	200
J77553*	8 x 1	100	J77585*	14 x 1 1/2	25	J77639**	10 x 1	150
J77561*	10 x 1/2	150	J77590*	5/16 x 1/2	100	J77640**	10 x 1/4	100
J77562*	10 x 3/4	125	J77592*	5/16 x 1	75	J77650**	12 x 3/4	200
J77563*	10 x 1	100	J77594*	5/16x1 1/2	50	J77652**	12 x 1/4	150
J77570*	12 x 1/2	125	J77600*	3/8 x 1	75	J77655**	12 x 2	100
J77572*	12 x 3/4	100	J77602*	3/8x1 1/2	50	J77667**	14 x 1	150
J77573*	12 x 7/8	75	J77626**	8 x 1/2	250	J77669**	14 x 1 1/2	100
J77574*	12 x 1	50	J77628**	8 x 3/4	200	J77671**	14 x 2	50
J77580*	14 x 1/2	100	J77629**	8 x 1	150			

* hex head—no washer

** slotted hex washer head



J99009 • SLOTTED PAN HEAD SMS ASSORTMENT

INCLUDES: 5,925 pcs. plus 40 Bin Cabinet

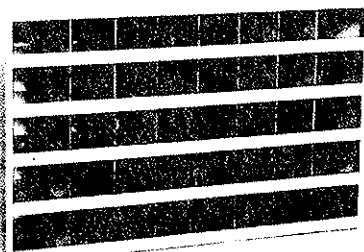

J40B
35 1/4" x 24" x 12"

HEAVY DUTY pigeon hole type storage bins produced of heavy gauge steel and finished in rust and acid resistant baked enamel will not warp, twist, or sag out of alignment.

PART#	SIZE	QTY	PART#	SIZE	QTY	PART#	SIZE	QTY
J77000	4 x 1/4	300	J77024	8 x 3/4	250	J77057	12 x 3/4	200
J77002	4 x 1/2	300	J77026	8 x 1	200	J77059	12 x 1	100
J77006	6 x 1/4	300	J77027	8 x 1 1/4	175	J77061	12 x 1 1/2	75
J77008	6 x 1/2	300	J77028	8 x 1 1/2	125	J77063	12 x 2	50
J77009	6 x 5/8	250	J77030	8 x 2	100	J77070	14 x 1/2	200
J77010	6 x 3/4	200	J77035	10 x 3/8	250	J77072	14 x 3/4	150
J77011	6 x 7/8	200	J77037	10 x 5/8	200	J77075	14 x 1 1/4	125
J77012	6 x 1	200	J77041	10 x 1 1/4	150	J77077	14 x 1 3/4	100
J77020	8 x 1/4	300	J77043	10 x 1 3/4	100	J77079	14 x 2 1/2	75
J77022	8 x 1/2	300	J77045	10 x 2 1/2	75	J77080	14 x 3	50
J77023	8 x 5/8	275	J77055	12 x 1/2	250			

ASSORTMENTS

J99002 • GRADE 8 USS ASSORTMENT

INCLUDES: 3,795 pcs. plus 72 Bin Cabinet

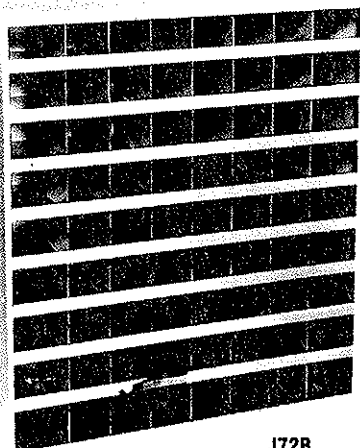

J72B
35 1/4" x 42" x 12"

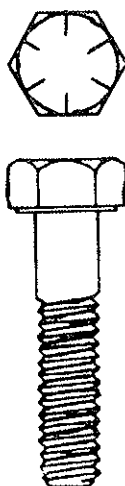

PART#	SIZE	QTY	PART#	SIZE	QTY	PART#	SIZE	QTY
J27000	1/4-20x1/2	80	J27043	3/8-16x1 1/4	60	J27500	1/4-20 N	100
J27002	1/4-20x3/4	60	J27044	3/8-16x1 1/2	60	J27501	5/16-20 N	100
J27003	1/4-20x1	60	J27045	3/8-16x1 1/2	50	J27502	3/8-16 N	100
J27004	1/4-20x1	40	J27046	3/8-16x2	40	J27503	7/16-14 N	80
J27005	1/4-20x1 1/2	40	J27060	7/16-14x3/4	30	J27504	1/2-13 N	60
J27006	1/2-20x1 3/4	30	J27061	7/16-14x1	40	J37004	1/4 L/W	100
J27007	1/4-20x2	30	J27063	7/16-14x1 1/2	40	J37005	5/16 L/W	100
J27020	5/16-18x1 1/2	80	J27064	7/16-14x1 3/4	40	J37006	3/8 L/W	100
J27021	5/16-18x3/4	100	J27065	7/16-14x2	30	J37007	7/16 L/W	100
J27022	5/16-18x1	100	J27067	7/16-14x2 1/2	15	J37008	1/2 L/W	100
J27023	5/16-18x1 1/4	60	J27079	1/2-13x3/4	20	J37204	1/4 FLAT	300
J27024	5/16-18x1 1/2	60	J27080	1/2-13x1	40	J37205	5/16 FLAT	325
J27026	5/16-18x2	40	J27082	1/2-13x1 1/2	30	J37206	3/8 FLAT	300
J27028	5/16-18x2 1/2	40	J27084	1/2-13x2	30	J37207	7/16 FLAT	275
J27041	3/8-16x3/4	60	J27086	1/2-13x2 1/2	10	J37208	1/2 FLAT	150
J27042	3/8-16x1	100	J27088	1/2-13x3	10			

J99003 • GRADE 8 SAE ASSORTMENT

INCLUDES: 3,795 pcs. plus 72 Bin Cabinet

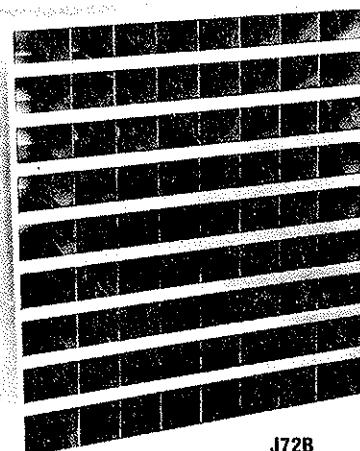

J72B
35 1/4" x 42" x 12"

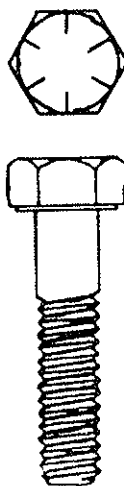

PART#	SIZE	QTY	PART#	SIZE	QTY	PART#	SIZE	QTY
J27550	1/4-28x1/2	80	J27593	3/8-24x1 1/4	60	J27800	1/4 N	100
J27552	1/4-28x3/4	60	J27594	3/8-24x1 1/2	60	J27801	5/16 N	100
J27554	1/4-28x1	60	J27595	3/8-24x1 3/4	50	J27802	3/8 N	100
J27555	1/4-28x1 1/4	40	J27596	3/8-24x2	40	J27803	7/16 N	80
J27556	1/4-28x1 1/2	40	J27610	7/16-20x3/4	30	J37804	1/2 N	60
J27557	1/4-28x1 3/4	30	J27611	7/16-20x1	40	J37004	1/4 L/W	100
J27558	1/2-20x2	30	J27613	7/16-20x1 1/2	40	J37005	5/16 L/W	100
J27570	5/16-24x1 1/2	80	J27615	7/16-20x2	40	J37006	3/8 L/W	100
J27571	5/16-24x3/4	100	J27617	7/16-20x1 1/2	30	J37007	7/16 L/W	100
J27572	5/16-24x1	100	J27619	7/16-20x3	15	J37008	1/2 L/W	100
J27573	5/16-24x1 1/4	60	J27630	1/2-20x3/4	20	J37254	1/4 FLAT	300
J27574	5/16-24x1 1/2	60	J27631	1/2-20x1	40	J37255	5/16 FLAT	325
J27576	5/16-24x2	40	J27633	1/2-20x1 1/2	30	J37256	3/8 FLAT	300
J27578	5/16-24x2 1/2	40	J27635	1/2-20x2	30	J37257	7/16 FLAT	275
J27590	3/8-24x1 1/2	60	J27637	1/2-20x2 1/2	10	J37258	1/2 FLAT	150
J27592	3/8-24x1	100	J27639	1/2-20x3	10			

J99004 • STANDARD METRIC CAP SCREW ASSORTMENT

INCLUDES: 3,455 pcs. plus 72 Bin Cabinet

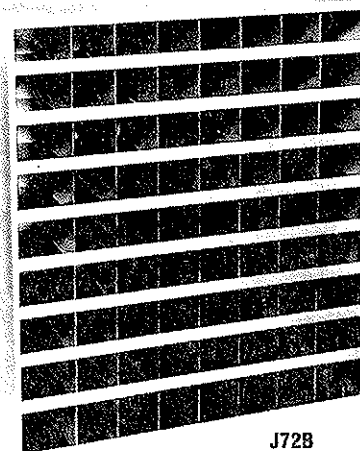

J72B
35 1/4" x 42" x 12"

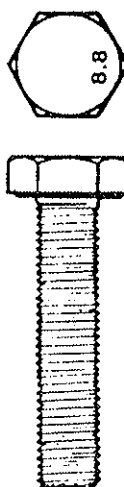

PART#	SIZE	QTY	PART#	SIZE	QTY	PART#	SIZE	QTY
J65300	M4x10	80	J65354	M8x20	80	J65593	M6 N	100
J65301	M4x12	80	J65356	M8x30	80	J65594	M8 N	50
J65302	M4x16	80	J65357	M8x35	80	J65595	M10 N	50
J65304	M4x25	80	J65359	M8x45	30	J65596	M12 N	50
J65306	M4x35	80	J65377	M10x20	25	J65661	M4 F	125
J65314	M5x10	80	J65378	M10x25	25	J65662	M5 F	125
J65316	M5x16	80	J65379	M10x30	20	J65663	M6 F	125
J65317	M5x20	80	J65381	M10x40	15	J65664	M8 F	250
J65319	M5x30	80	J65382	M10x45	15	J65665	M10 F	100
J65321	M5x40	80	J65403	M12x20	15	J65666	M12 F	50
J65331	M6x12	80	J65404	M12x25	25	J65674	M4 L/W	125
J65332	M6x16	80	J65405	M12x30	15	J65675	M5 L/W	125
J65333	M6x20	80	J65407	M12x40	15	J65676	M6 L/W	125
J65334	M6x25	80	J65408	M12x45	10	J65677	M8 L/W	250
J65336	M6x35	80	J65591	M4 N	100	J65678	M10 L/W	50
J65352	M8x12	80	J65592	M5 N	100	J65679	M12 L/W	50

ASSORTMENTS

J99025 • GRADE 5 USS ASSORTMENT

INCLUDES: 3,795 pcs. plus 72 Bin Cabinet

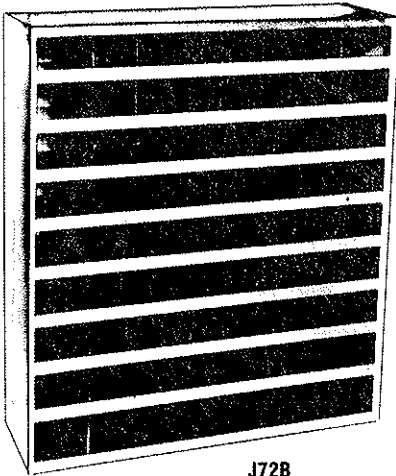

J72B
35 1/4" x 42" x 12"

PART#	SIZE	QTY	PART#	SIZE	QTY	PART#	SIZE	QTY
J16000	1/4-20x1/2	80	J16043	3/8-16-1 1/4	60	J16500	1/4-20 N	100
J16002	1/4-20-3/4	60	J16044	3/8-16x1 1/2	60	J16501	5/16-18 N	100
J16003	1/4-20x1	60	J16045	3/8-16x1 3/4	50	J16502	3/8-16 N	100
J16004	1/4-20x1 1/4	40	J16046	3/8-16x2	40	J16503	7/16-14 N	100
J16005	1/4-20x1 1/2	40	J16060	7/16-14x3/4	30	J16504	1/2-13 N	100
J16006	1/4-20x1 3/4	30	J16061	7/16-14x1	40	J37004	1/4 L/W	100
J16007	1/4-20x2	30	J16063	7/16-14x1 1/2	40	J37005	5/16 L/W	100
J16020	5/16-18x1/2	80	J16064	7/16-14x1 3/4	40	J37006	3/8 L/W	100
J16021	5/16-18-3/4	100	J16065	7/16-14x2	30	J37007	7/16 L/W	100
J16022	5/16-18x1	100	J16067	7/16-14x2 1/2	15	J37008	1/2 L/W	100
J16023	5/16-18x1 1/4	60	J16079	1/2-13x3/4	20	J37204	1/4 FLAT	300
J16024	5/16-18x1 1/2	60	J16080	1/2-13x1	40	J37205	5/16 FLAT	325
J16026	5/16-18x2	40	J16082	1/2-13x1 1/2	30	J37206	3/8 FLAT	300
J16028	5/16-18x2 1/2	40	J16084	1/2-13x2	30	J37207	7/16 FLAT	275
J16041	3/8-16x3/4	60	J16086	1/2-13x2 1/2	10	J37208	1/2 FLAT	150
J16042	3/8-16x1	100	J16088	1/2-13x3	10			

J99026 • GRADE 5 USS & STD METRIC ASSORTMENT

INCLUDES: 1,580 pcs. plus HD 72 Bin Cabinet

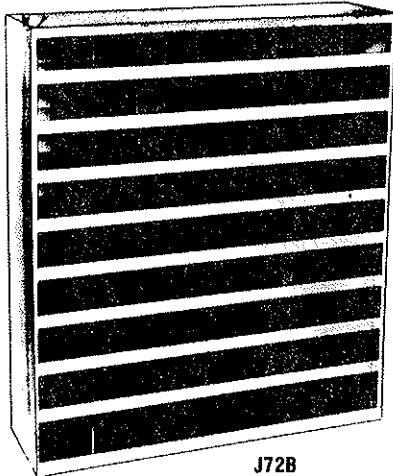

J72B
35 1/4" x 42" x 12"

PART#	SIZE	QTY	PART#	SIZE	QTY	PART#	SIZE	QTY	SIZE#	SIZE	QTY
J16000	1/4-20x1/2	20	J16061	7/16-14x1	20	J65331	M6x12	20	J65404	M12x25	10
J16002	1/4-20-3/4	20	J16062	7/16-14x1 1/4	20	J65332	M6x16	20	J65405	M12x30	10
J16003	1/4-20x1	20	J16063	7/16-14x1 1/2	20	J65333	M6x20	20	J65407	M12x40	10
J16005	1/4-20x1 1/2	20	J16065	7/16-14x2	20	J65334	M6x25	20	J65408	M12x45	10
J16007	1/4-20x2	20	J16500	1/4-20 N	30	J65335	M6x30	20	J65593	M6 NUT	30
J16021	5/16-18-3/4	20	J16501	5/16-18 N	30	J65352	M8x12	20	J65594	M8 NUT	30
J16022	5/16-18x1	20	J16502	3/8-16 N	30	J65354	M8x20	20	J65595	M10 NUT	30
J16023	5/16-18x1 1/4	20	J16503	7/16-14 N	30	J65356	M8x30	20	J65596	M12 NUT	30
J16024	5/16-18x1 1/2	20	J37004	1/4 L/W	30	J65357	M8x35	20	J65663	M6 FLAT	50
J16026	5/16-18x2	20	J37005	5/16 L/W	30	J65359	M8x45	20	J65664	M8 FLAT	50
J16041	3/8-16x3/4	20	J37006	3/8 L/W	30	J65377	M10x20	10	J65665	M10 FLAT	30
J16042	3/8-16x1	20	J37007	7/16 L/W	30	J65378	M10x25	10	J65666	M12 FLAT	30
J16043	3/8-16-1 1/4	20	J37204	1/4 FLAT	50	J65379	M10x30	10	J65676	M6 L/W	50
J16044	3/8-16x1 1/2	20	J37205	5/16 FLAT	50	J65381	M10x40	10	J65677	M8 L/W	50
J16046	3/8-16x2	20	J37206	3/8 FLAT	50	J65382	M10x45	10	J65678	M10 L/W	30
J16060	7/16-14x3/4	20	J37207	7/16 FLAT	50	J65403	M12x20	10	J65679	M12 L/W	30





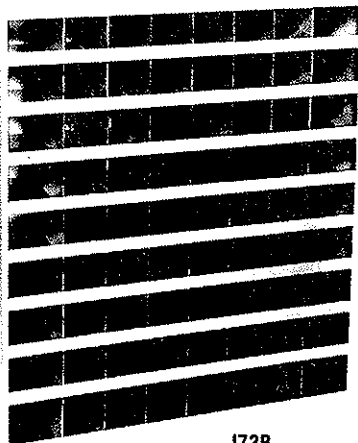





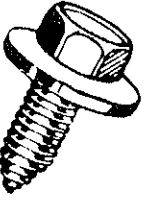

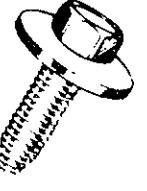



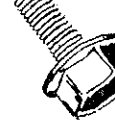



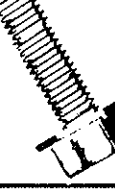





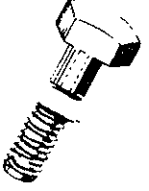

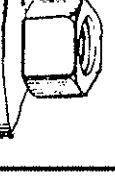
J99027 • GRADE 8 USS & STD METRIC ASSORTMENT

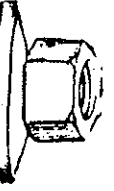
INCLUDES: 1,580 pcs. plus HD 72 Bin Cabinet







































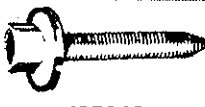









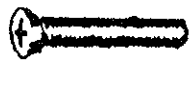

J72B
35 1/4" x 42" x 12"

PART#	SIZE	QTY	PART#	SIZE	QTY	PART#	SIZE	QTY	SIZE#	SIZE	QTY
J27000	1/4-20x1/2	20	J27061	7/16-14x1	20	J65331	M6x12	20	J65404	M12x25	10
J27002	1/4-20x3/4	20	J27062	7/16-14x1 1/4	20	J65332	M6x16	20	J65405	M12x30	10
J27003	1/4-20x1	20	J27063	7/16-14x1 1/2	20	J65333	M6x20	20	J65407	M12x40	10
J27005	1/4-20x1 1/2	20	J27065	7/16-14x2	20	J65334	M6x25	20	J65408	M12x45	10
J27007	1/4-20x2	20	J27500	1/4-20 N	30	J65335	M6x30	20	J65593	M6 NUT	30
J27021	5/16-18x3/4	20	J27501	5/16-18 N	30	J65352	M8x12	20	J65594	M8 NUT	30
J27022	5/16-18x1	20	J27502	3/8-16 N	30	J65354	M8x20	20	J65595	M10 NUT	30
J27023	5/16-18x1 1/4	20	J27503	7/16-14 N	30	J65356	M8x30	20	J65596	M12 NUT	30
J27024	5/16-18x1 1/2	20	J37004	1/4 L/W	30	J65357	M8x35	20	J65663	M6 FLAT	50
J27026	5/16-18x2	20	J37005	5/16 L/W	30	J65359	M8x45	20	J65664	M8 FLAT	50
J27041	3/8-16x3/4	20	J37006	3/8 L/W	30	J65377	M10x20	10	J65665	M10 FLAT	30
J27042	3/8-16x1	20	J37007	7/16 L/W	30	J65378	M10x25	10	J65666	M12 FLAT	30
J27043	3/8-16x1 1/4	20	J37204	1/4 FLAT	50	J65379	M10x30	10	J65676	M6 L/W	50
J27044	3/8-16x1 1/2	20	J37205	5/16 FLAT	50	J65381	M10x40	10	J65677	M8 L/W	50
J27046	3/8-16x2	20	J37206	3/8 FLAT	50	J65382	M10x45	10	J65678	M10 L/W	30
J27060	7/16-14x3/4	20	J37207	7/16 FLAT	50	J65403	M12x20	10	J65679	M12 L/W	30

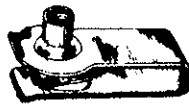
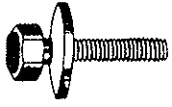
 J65089 REPLACES 11501188 8mm x 13/16 (30)	 J65084 M6 x 25 HEX WASHER HEAD (20)	 J65103 REPLACES 11500754 6mm x 25mm (30)	 J65092 REPLACES 11500986 7.9mm x 16mm (30)	 J65093 REPLACES 11500969 8mm x 20mm (30)	 J65094 REPLACES 11500961 6.3mm x 20mm (30)	 J65100 REPLACES 11500983 4mm x 11mm (75)	 J65091 REPLACES 11500970 8mm x 25mm (30)
 J65046 REPLACES 11501184 6.3mm x 40mm Grade 9.8 (30)	 J65045 REPLACES 11503407 12mm x 1.75 x 95mm (10)	 J65099 REPLACES 11502480 8mm x 20mm (20)	 J65078 REPLACES 11504303 6mm x 1 x 25mm (30)	 J65079 REPLACES 11504501 8mm x 1.25 x 30mm (30)	 J65080 REPLACES 11504499 8mm x 1.25 x 25mm (30)	 J65072 REPLACES 11503616 6.3mm x 25mm Black (30)	 J65073 REPLACES 11503752 8mm Green (30)
 J65074 REPLACES 11503753 6mm Green (30)	 J65075 REPLACES 371964 8mm Blue (30)	 J65085 REPLACES 11504023 6mm x 65mm (30)	 J65082 REPLACES 11501917 7.9mm x 1.59 x 20mm (30)	 J65095 REPLACES 11501106 6.3 mm (30)	 J65097 REPLACES 11500401 8mm (30)	 J65096 REPLACES 11500371 6.3mm (30)	 J65098 REPLACES 11501850 10mm (30)
 J65008 REPLACES 11502635 8mm x 13mm HEX (20)	 J65057 REPLACES 560710 6.4mm Black (30)	 J65034 REPLACES 11500655 4mm x 0.7 Third Pitch (30)	 J65063 REPLACES 11501909 7.5mm x 16mm and 6.5mm x 20.6mm Blue (15)	 J65065 REPLACES 11502618 4mm x 7 x 16mm Blue (30)	 J65007 REPLACES 11500747 6.3mm x 11mm HEX (50)	 J65066 REPLACES 11502623 4mm x .7 x 20mm Blue (30)	 J65102 REPLACES 1609880 4mm x 25mm (30)

J99010 • UNIVERSAL GM METRIC ASSORTMENT
INCLUDES: 960 pcs. plus 40 Bin Cabinet

 J65000 REPLACES 11501014 PHOS STUD 63mm HEX 11mm O.D. 18mm Washer Type Metric (50)	 J65005 REPLACES 11048281 8mm x 1.25 x 18mm Grade 9.8 Indented Hex Hd. Bolt w/Waved Spring Washer (20)	 J65006 REPLACES 11501102 8mm x 1.25 x 25mm Grade 9.8 Indent. Hex Hd. Bolt Type w/Conical Wshr. (30)	 J65009 REPLACES 11502520 4mm x 9mm HEX Hex Stmpd Nut, Self-Thrd. (25)	 J65010 REPLACES 11501793 5mm x 10mm HEX Stamped Nut Self-Thrd. (25)	 J65012 REPLACES 11503417 6.3mm x 13mm HEX Stamped Nut, Self-Thrd. (25)
 J65014 REPLACES 11501914 5mm x 13mm HEX Nut, Acorn, Self-Thrd. (25)	 J65016 REPLACES 11501937 4mm x 11mm Push on Nut, Round (25)	 J65017 REPLACES 1703731 8mm x 16mm Push on Nut, Round (50)	 J65018 REPLACES 11502504 8mm x 16mm Zinc Plated Push on Nut, Round (50)	 J65020 REPLACES 11502737 12mm x 21mm Push on Nut Round (25)	 J65022 REPLACES 11502549 4mm x 9mm Stamped Nut, Self-Thrd. w/ 15mm Integ. Wshr. (50)
 J65023 REPLACES 11501855 5mm x 10mm HEX Stamped Lock Nut w/Sealer & 14mm Integral Washer (50)	 J65024 REPLACES 11501814 5mm x 10mm HEX Stamped Lock Nut w/14 mm Integral Washer (50)	 J65027 REPLACES 11501047 5mm x 10mm HEX Stamped Hex HD Nut w/ 15mm Integ. Wshr & Sealer (25)	 J65028 REPLACES 11501861 6.3mm x 11mm HEX Stamped Nut, Self-Thrd. w/18mm Integral Wshr and Sealer (50)	 J65031 REPLACES 11501899 6.3mm x 11mm HEX Stamped Hex Nut Self Thrd. w/ 24mm Integ Wshr & Sealer (50)	 J65033 REPLACES 11500654 4mm x 0.7 Thrd. Pitch (20)
 J65034 REPLACES 11500656 4mm x 0.7 Thrd. Pitch (20)	 J65035 REPLACES 11500657 5mm x 0.8 Thrd Pitch (20)	 J65036 REPLACES 11502785 6.3mm x 1.0 Thrd. Pitch (20)	 J65039 REPLACES 368257 4.2mm x 1.41 x 58mm (10)	 J65040 REPLACES 11501193 10mm x 40mm (10)	 J65042 REPLACES 11502517 16mm x 24mm Hex (25)

 J65044 REPLACES 371914 8mm Nut, Metric Hood Leveling (10)	 J65045 REPLACES 11503407 12mm x 1.75 x 95mm (10)	 J65046 REPLACES 11501184 6.3mm x 40mm Grade 9.8 (20)	 J65047 REPLACES 11502739 10mm x 35mm Grade 9.8 (10)	 J65048 REPLACES 11502762 10mm x 22mm (10)	 J65049 REPLACES 11502763 8mm Blue (20)	 J65051 REPLACES 11503455 8mm Blue, Panel Range 2.0mm - 5.0mm (20)
 J65053 REPLACES 11502581 5mm x 13mm Hex (10)	 J65057 REPLACES 560710 6.4mm Black (20)	 J65058 REPLACES 365718 6.3mm x 25mm Black (20)	 J65063 REPLACES 11501909 7.5mm x 16mm and 6.3mm x 20.6mm (05)	 J65065 REPLACES 11502618 4mm x 0.7 x 16mm Blue (20)	 J65066 REPLACES 11502623 4mm x 0.7 x 20mm Blue (20)	
 J65068 REPLACES 11503716 6mm x 1.0 Thrd. Pitch (20)	 J65069 REPLACES 11502783 6.3mm x 35mm (20)	 J65070 REPLACES 2539276 12mm x 15 (25)	 J65071 REPLACES 11501849 10mm Bolt Size (25)	 J65075 REPLACES 371964 8mm Blue (10)	 J65076 REPLACES 11503715 6mm Long Throat (10)	
 J65078 REPLACES 11504303 6mm x 1.0 x 25mm (10)	 J65079 REPLACES 11504501 8mm x 1.25 and 30mm (10)	 J65080 REPLACES 11504499 8mm x 1.25 x 25mm (10)	 J65083 REPLACES 11502609 8mm Hex Wshr. Nut, Metric (10)	 J65082 REPLACES 11501917 7.9mm x 1.59 x 20mm (10)	 J65087 REPLACES 3682161 Nut, Spare Tire Hold Down (05)	

J99000 • GM METRIC ASSORTMENT
INCLUDES: 1,110 pcs. and 56 Bin Cabinet

ASSORTMENTS

J83 5666

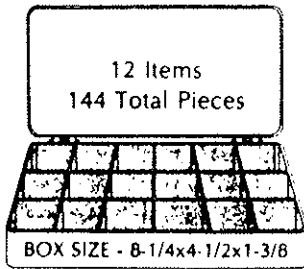

TRIM PANEL ANCHOR NUTS & BUMPER FLAP CLIPS
for JAPANESE CARS



- Contains -

12 each 81-5293	12 each 81-5389	12 each 81-5416
12 each 81-5332	12 each 81-5392	12 each 81-5419
12 each 81-5385	12 each 81-5394	12 each 81-5420
12 each 81-5386	12 each 81-5415	12 each 82-5506

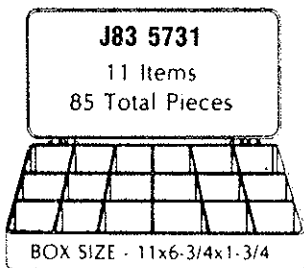

REPLACEMENT DOOR HINGE PINS & BUSHINGS
for G.M., FORD & CHRYSLER CARS

- Contains -

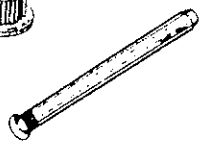

10 each J81 5307	10 each J83 5724	5 each J83 5709
10 each J81 5308	10 each J83 5725	5 each J83 5710
10 each J83 5711	5 each J83 5707	5 each J83 5737
10 each J83 5712		5 each J83 5738

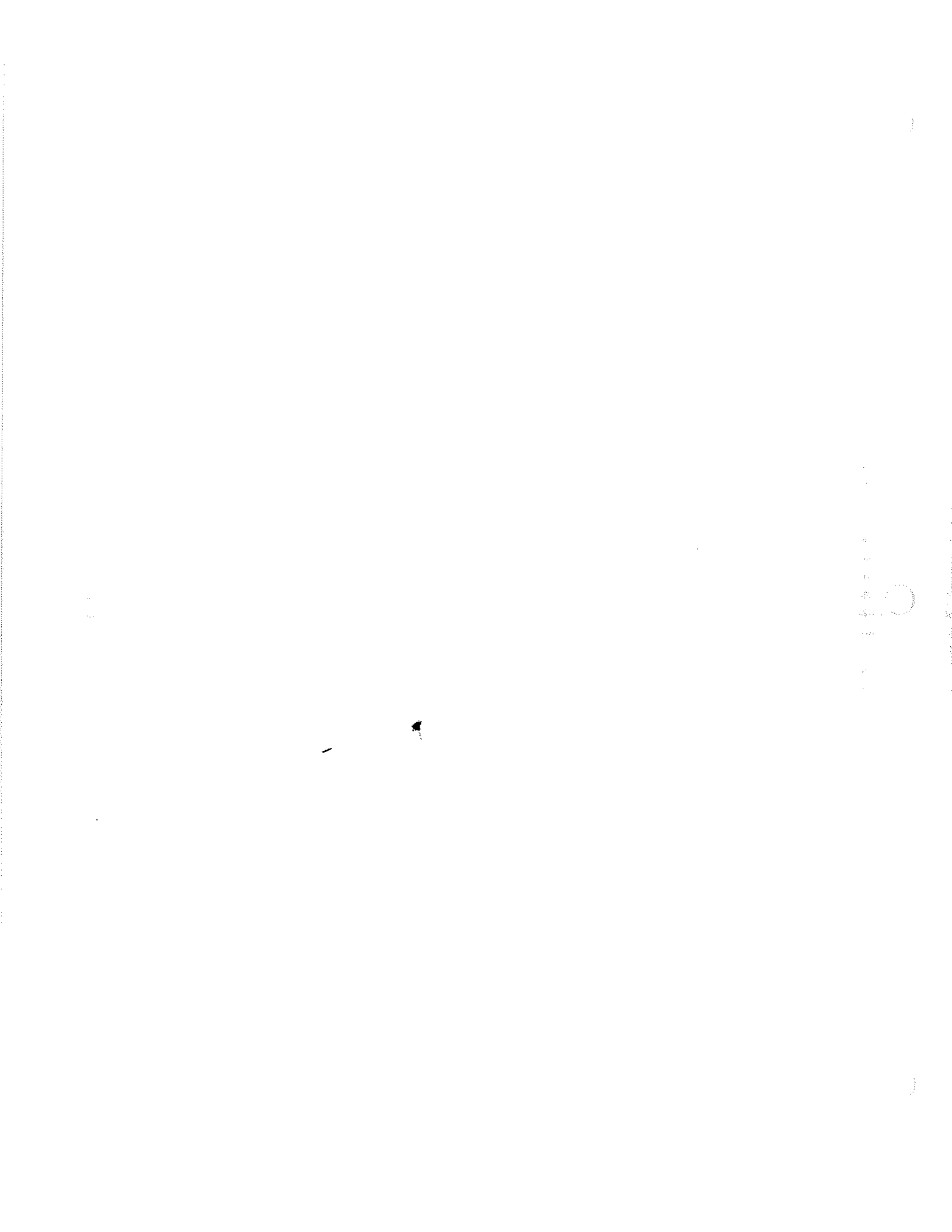

ELECTRICAL SUPPLIES

SECTION 4

	PAGE
ADAPTORS.....	2
ALKALINE BATTERIES.....	6
ALLIGATOR CLIPS.....	8
ATO FUSES.....	14
BATTERIES, GENERAL PURPOSE.....	6
BATTERY HARDWARE.....	8-10
Cable Ends.....	8,9,10
Cable Straights, Ends, Flags, Elbows.....	9
Marine Terminals.....	8
Starter Lugs.....	10
Stud Top Nuts.....	10
Terminals.....	8,9,10
Washers.....	8
BOOSTER CABLE CLAMPS.....	4
BOOSTER CABLES.....	4
BULBS.....	11
CERAMIC FUSES.....	13,14
CIRCUIT BREAKERS.....	14
CLEAR BULBS.....	12
CLEARANCE LIGHTS.....	17
CONNECTORS.....	18
DOME LIGHTS.....	17
DROP LIGHTS.....	1,2
ELECTRICAL PLUGS.....	2
ELECTRICAL TAPE.....	16
EXTENSION CORDS.....	3
EXTENSION REELS.....	3
FLASHERS.....	16
FLASH LIGHTS.....	6
FLOOD LIGHTS.....	12
FLUORESCENT BULBS.....	12
FUSE ASSORTMENTS.....	14,15
FUSES-GLASS, ATO, CERAMIC, MAXI, MINI.....	13,14,15
FUSE HOLDERS.....	14
GENERAL PURPOSE BATTERIES.....	6
GLASS FUSES.....	13
HALOGEN BEAMS.....	11
HALOGEN BULBS.....	11
HEAT LAMP.....	12
HEAT SHRINK TUBING.....	9
JUMPER CABLES.....	4
LAMP KIT.....	17

LENSES.....	17
LIGHT BULBS.....	12
LIGHT MATE.....	18
LIGHT REELS.....	2
LOOM.....	16
MARKER LIGHTS.....	17
MAXI FUSES.....	15
MECHANICS LIGHTS.....	1
MINI FUSES.....	15
MINI LIGHT.....	17
MINIATURE BULBS.....	11
PAL AUTO LINK FUSES.....	13
PIGTAILS-SEALED BEAMS.....	12
PLASTIC HALOGEN BEAMS.....	11
PLUGS.....	2
POWER OUTLET REEL.....	3
PRIMARY WIRE.....	7
PUSH BUTTON SWITCHES.....	5
REFLECTORS.....	17
REFLECTOR TAPE.....	17
REPLACEMENT LENSES.....	17
REPLACEMENT PARTS FOR DROP CORDS, TROUBLE LIGHTS.....	2
RUFF SERVICE BULBS.....	12
SEALED BEAM CONNECTORS.....	12
SEALED BEAMS.....	11
SEALING COMPOUND.....	16
SOCKETS-SEALED BEAMS.....	12
SOLDER-ACID, ROSIN CORE.....	7
SPEAKER WIRE.....	7
STATIC PROTECTION KIT.....	7
STOP, TAIL, TURN LIGHTS.....	17
SWITCHES.....	5
TAPE-ELECTRICAL.....	16
TOGGLE SWITCHES.....	5
TRACTOR LIGHTS.....	17
TRAILER WIRING.....	18
TROUBLE LIGHTS.....	1,2
TURN SIGNAL LIGHTS.....	17
WIRE.....	7
WIRE LOOM.....	16
WIRING HARNESS.....	18

ELECTRICAL SUPPLIES



—TROUBLE LIGHTS—

Made to meet
OSHA
Specifications

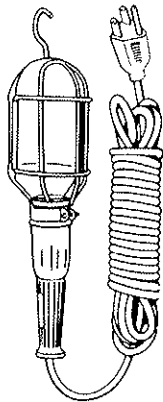

CAROL CABLE Heavy-Duty Rubber Cable

3 conductor, UL listed, yellow, SJO Vu-Tron® Jacket, oil resistant, without switch and side outlet. Yellow coated metal guard. Meets OSHA requirements for special applications.

T04445 18/3 SJO 25' Yellow (Old# T383)
T04446 18/3 SJO 50' Yellow (Old# T384)

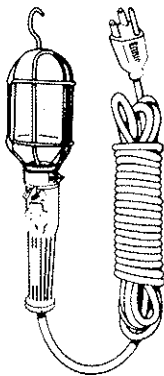

CAROL CABLE Heavy-Duty Vinyl Cable

3 conductor, UL listed, yellow, SJT jacket, switch and side outlet. Metal grounded guard with hook. Meets OSHA requirements for general use.

T04464 18/3 SJT 25' Orange (Old# T681)
T682 18/3 SJT 50' Yellow

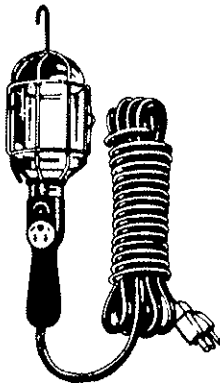

CORDOMATIC Heavy-Duty Grounded

Designed to take roughest handling. Impact resistant pistol grip handle. Built-in convenience outlet. Swing open metal guard and reflector.

T125DCG 18/3 SJT 25' 10 amps
T150DCG 18/3 SJT 50' 10 amps

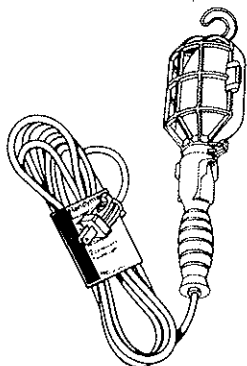

CORDOMATIC Heavy-Duty

These heavy-duty drop lights include molded plug, impact resistant pistol grip handle and fully vinyl insulated swing open guard and reflector. No switch and side outlet.

T325DCN 18 SJT 25' 10 amps

ELECTRICAL SUPPLIES

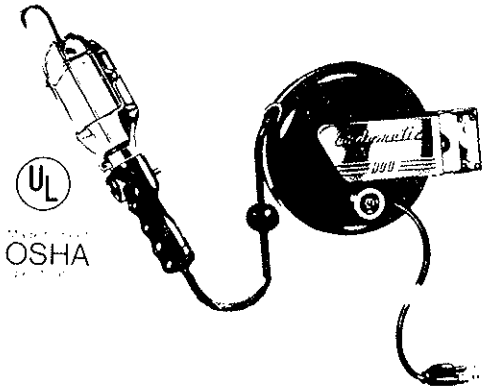

UL
OSHA

CORDOMATIC Heavy-Duty Drop Light Reel

The Cordomatic grounding type reels are designed to meet the most rigid demands that require grounding of circuits for electrical equipment. These units feature a grounding type convenience outlet in the handle, a grounding type molded male plug cap and a time-proven switch.

T900G 18/3 SJO 30' 7 amps
T950G 18/3 SVO 50' 7 amps

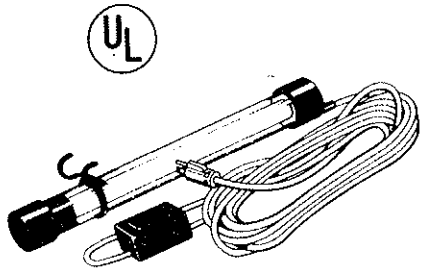

UL

CAROL CABLE Fluorescent Trouble Light

Lightweight fluorescent lamps stay cool in use. Bulb is protected by a thick, transparent, shatter-resistant housing. Fitted with switch, reflector and adjustable hanger. Oil resistant, bright yellow cable and black vinyl, encased transformer.

T04460 18/3 SJT 25 Yellow
T379 Replacement Bulb

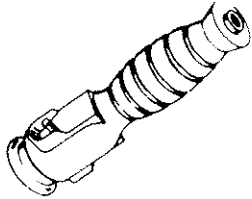

Two Wire Handle w/Switch

Durable, rubber handle. 2 wire with socket, switch and outlet.
Part No. T334

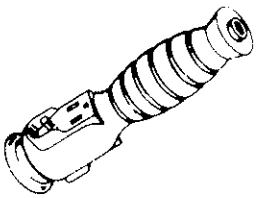

Three Wire Handle w/Switch

Phenolic handle, high impact. UL listed. 3 wire with switch and side outlet.
Part No. T336

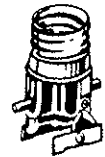

UL

SWITCH

Switch mechanism and socket. 2-wire, durable.

Part No. T333



ELECTRICAL ADAPTER

2 to 3 wire adapter. Vinyl grounding connector.

Part No. T566

MALE/FEMALE Electrical Plugs



2-Wire male plug
Part No. T420



2-Wire, male plug
w/cable clamp.
Part No. T431



2-Wire, female connector
w/cable clamp.
Part No. T432



3-wire C.G. female end,
armored 3-wire.
Part No. T764

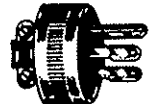

3-wire C.G. attachment
plug armored 3-wire.
Part No. T763

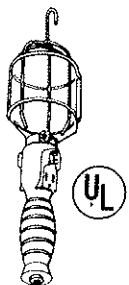

UL

CORDOMATIC Deluxe Handle Assembly

Crack-proof, heat resistant, pistol grip handle with convenience outlet. Built-in strain relief. Swing open guard and reflector.

T400HAG

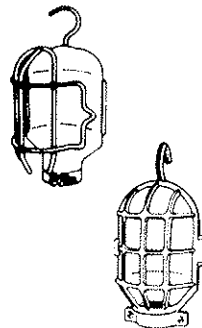

Lamp Safety Guards

Side opening cages, for easy bulb change.

T44701 Yellow Polypropylene
Insulated (Old# T310)

T01770 Aluminum Painted
(Old# T309)

ELECTRICAL SUPPLIES

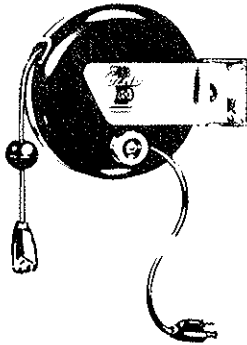

CORDOMATIC Grounding Type Power Outlet Reel

3-wire grounding type cord reel, especially designed to meet the most rigid demands that require grounding of circuits for electrical equipment.

T500P 16/3 SPT2 20' 9 amps



CAROL CABLE Heavy-Duty Extension Cord

For outdoor or indoor use from standard to hard surface. Vinyl insulation stays flexible in cold weather, resists deterioration caused by oil, grease, moisture, abrasion and prolonged exposure to sunlight. Rugged, solid molded plugs on non-marking cords.

T03825 14/3 SPT-3 25' Yellow (Old# T34)

T03850 14/3 SPT-3 50' Yellow (Old# T35W)



CAROL CABLE Outdoor Heavy-Duty Extension Cord

3 Conductor, UL Listed, vinyl, safety orange". Meets OSHA Requirements for outdoor and indoor use.

T03328 14/3 SJTW-A 25' orange (Old# T625)

T03356 14/3 SJTW-A 50' orange (Old# T626)

T03304 14/3 SJTW-A 100' orange (Old# T627W)

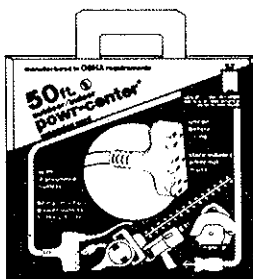

CAROL CABLE Outdoor Heavy-Duty Powr-Center®

3 grounded outlets, 3 conductor, UL listed, STW-A type. Vinyl, safety orange®. Meets OSHA requirements for outdoor and indoor use.

T00591 14/3 STW-A 25' orange (Old# T825)

ELECTRICAL SUPPLIES



CAROL CABLE Tangle-Proof® Booster Cables

T20612 12' 6 Ga. Copper, Yellow
Vu-Tron, 500 AMP
Klondike Clamps.
(Old# T76X)

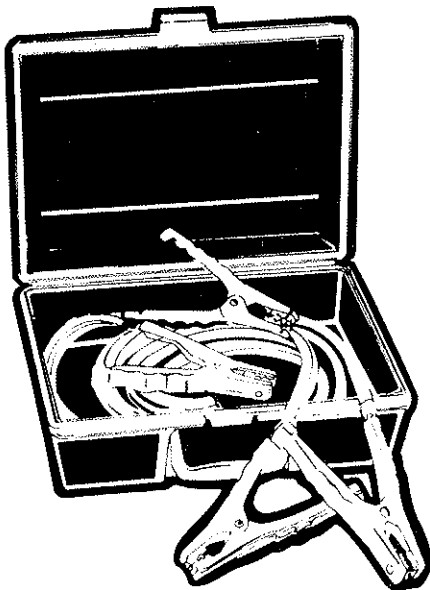

CAROL CABLE Heavy-Duty Booster Cables

T21420 20' 4 Ga. Copper, Orange
Vu-Tron, 500 AMP
Klondike Clamps.
(Old# T77)

CAROL CABLE Solid Copper Battery Clamps



"The clip that really clamps." Complete with vinyl plastic handle guards. Lead coated 5 coil spring.

TC75R 75 amp red (Old# T9B)
TC75B 75 amp black (Old# T9R)

CAROL CABLE Heavy-Duty, Fully Insulated Klondike® Clamps

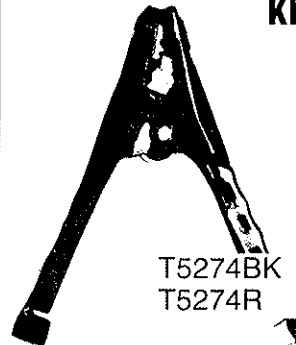

For booster cables, battery chargers and other heavy-duty uses. For side terminal and top post batteries—500 AMP solid copper contacts.

T5274BK 500 amp black (Old# T15B)
T5274R 500 amp red (Old# T150R)

ELECTRICAL SUPPLIES

UNIVERSAL EXTRA HEAVY DUTY TOGGLE SWITCHES

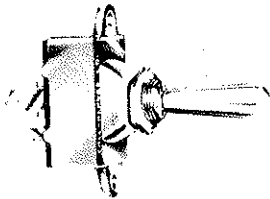

No.T551800 S.P.S.T.

- 2 positions: On-Off.
- 2 screw terminals.

No.T551802 S.P.D.T.

- 3 positions: On-Off-On.
- 3 screw terminals

MOMENTARY PUSH BUTTON SWITCHES

With protective rubber cap to guard against dust and moisture.

No.T9245 EXTRA HEAVY DUTY

- Protective cap snaps over specially designed aluminum mounting nut.
- Silver contacts.
- 2 screw terminals with lock washers.
- Mtg. stem $\frac{5}{8}$ " dia. $2\frac{1}{2}$ " long.

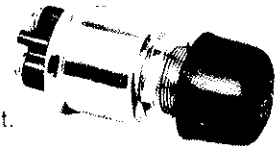

TOGGLE SWITCH FACE PLATE

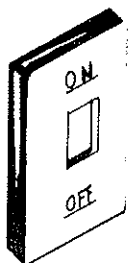

FACE PLATE DIMENSIONS

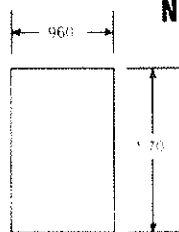

No.T8250

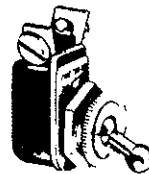

COLE HERSEE
2 Wire Toggle
T5568

ELECTRICAL SUPPLIES

ALKALINE ENERGY CELL BATTERIES

Longest possible life in constant or intermittent use

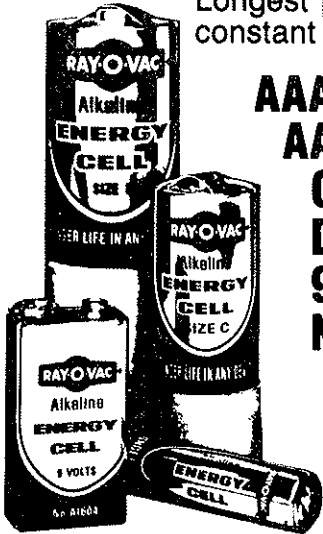

AAA size	T824
AA size	T815
C size	T814
D size	T813
9 volt	TA16041
N size	T810

3 VOLT LITHIUM TBR2016

FLASHLIGHT-2CELL

Powerful alkaline magnet in sturdy housing, separated from switch. Standard size-uses two D size batteries and No.PR2 bulb.

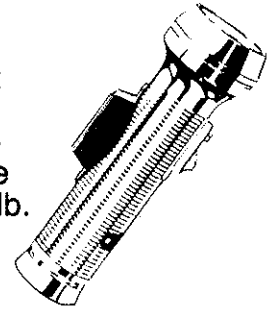

TS22M

WORKHORSE FLASHLIGHT

Super-bright Krypton bulb produces 70% more light than ordinary bulbs. Lens focuses the light into a powerful parallel beam. Durable, tested switch and easy to handle ribbed case.

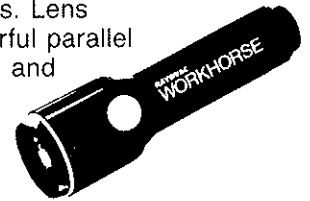

TWH2

TK22
Replacement Bulbs.

HEAVY DUTY BATTERIES



6 volt size	T944
9 volt size	TD16041

GENERAL PURPOSE BATTERIES

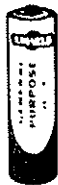

AA size	T7AA
C size	T1CFB
D size	T2DFB

RUBBER FLASHLIGHT-2 CELL

Rubber end caps, fiber barrel and three position switch with signal button. Uses two D size batteries and No.PR2 bulb.

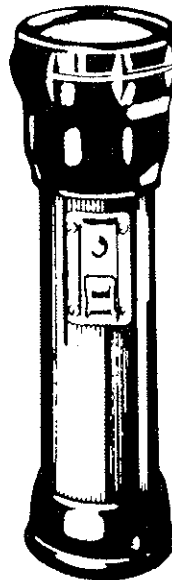

TBR22

ELECTRICAL SUPPLIES

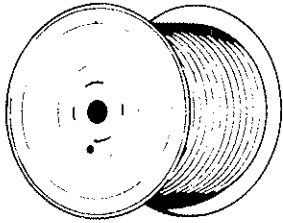

SOLDER

TAC1 ACID CORE
1LB ROLL 30/70

TRC1 ROSIN CORE
1LB ROLL-40/60

TTRC1 THIN STRAND/ROSIN CORE
1LB ROLL-40/60

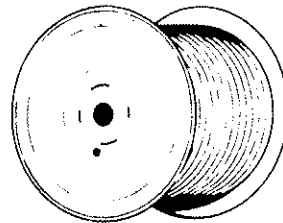

SPEAKER WIRE

2 wire jacketed.

TSPT-1 24ga.

TSPT-2 20ga.



3M STATIC PROTECTION KIT - T18293

Designed to protect the sophisticated electronics in today's automobile from damage that can be caused by static electricity. The kit consists of: (1) elastic wrist band to drain static away from wearer (2) a flexible work mat to drain static off of any conductive objects placed on it (3) a ground cord to connect those 2 components together and attach them to the frame of the car (an effective ground plane).

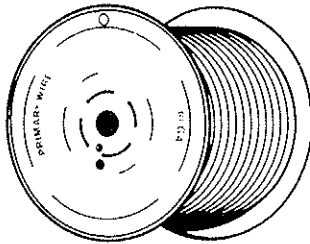

INSULATED PRIMARY WIRE

Meets S.A.E. specifications. Abrasion, oil, acid, flame resistant stranded copper wire for high conductivity. Color-coded as required by I.C.C. and A.T.A.. (100 ft.)

GAUGE \ COLOR	BLACK	RED	BLUE	BROWN	GREEN	WHITE	YELLOW	ORANGE
10	T10GAB	T10GAR	T10GABL	T10GABR	T10GAG	T10GAW	T10GAY	
12	T12GAB	T12GAR	T12GABL	T12GABR	T12GAG	T12GAW	T12GAY	T12GAO
14	T14GAB	T14GAR	T14GABL	T14GABR	T14GAG	T14GAW	T14GAY	T14GAO
16	T16GAB	T16GAR	T16GABL	T16GABR	T16GAG	T16GAW	T16GAY	
18	T18GAB	T18GAR	T18GABL	T18GABR	T18GAG	T18GAW	T18GAY	

ELECTRICAL SUPPLIES

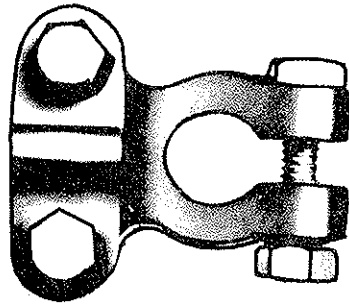
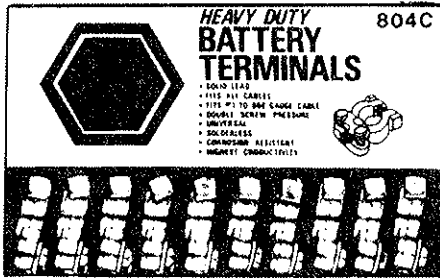

MARINE TERMINAL CLAMPS - LEAD AND BRASS

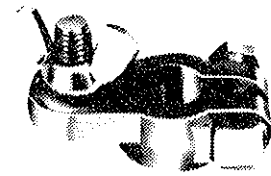

T551810

Lead clamps with bolts and nuts
5/16" stud with wing nut 10 per box

Heavy Duty UNIVERSAL BATTERY TERMINAL

- *Universal - Holds cable and strap
- *Fits positive or negative posts
- *Bolt locks firmly from left to right
- *Steel inserts - Avoid stripping
- *Threaded clamp avoids pull-out
- *Removable plate for easy assembly

BOARD OF TEN 804C

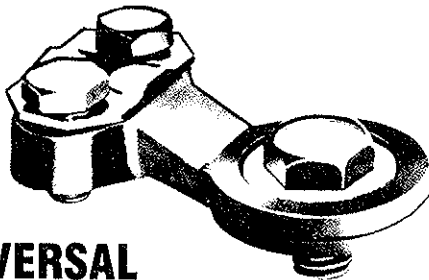
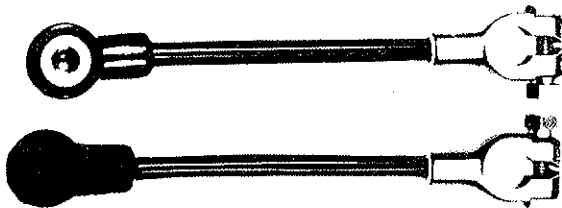

UNIVERSAL Side Post BATTERY TERMINAL

Clamps securely on 8 to 2'0' Ga. cable with strong bolts and nuts. Die cast from antimonial reinforced lead which is most impervious to sulfuric acid corrosion.

Part No. T5577-10

TEN PER CARD

Universal side terminals for all S/T battery cables used with S/T batteries.

ALLIGATOR CLIPS

Part No. TC609C



Heavy duty clips, used for temporary electrical connections.

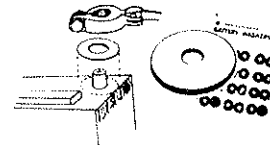

FELT BATTERY WASHERS

Part No. TWS618

Chemically treated felt battery washers save terminals and cables.No-corrode.

ELECTRICAL SUPPLIES

STUD TYPE BATTERY TERMINALS

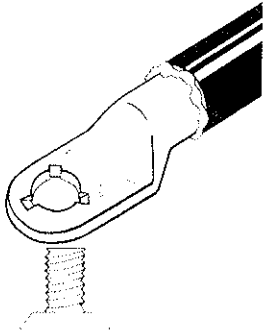

- **Lead plating** offers much greater corrosion resistance than tin plating in hostile battery environment.
- **Closed barrel** at tongue end prevents toxic fumes or liquids from penetrating cable.
- **Reliable crimp** with existing tools. Tool die codes are marked on the tongue of each terminal.
- **Anti rotational** tongue breaks thru oxide film on lead battery pedestal assuring a quality electrical connection.

CATALOG NO.	DESCRIPTION	CABLE SIZE	POLARITY	COLOR H.S. TUBING
N20BTRED	Terminal	2:0	Positive	Red
N20BTBLK	Terminal	2:0	Negative	Black
N30BTRED	Terminal	3:0	Positive	Red
N30BTBLK	Terminal	3:0	Negative	Black

POST TYPE BATTERY TERMINALS

straights



CATALOG NO.	CABLE SIZE	POLARITY	COLOR DIE CODE	LETTER DIE CODE
N4UTS	4	Universal	Green	JH
N12NTS	1 & 2	Negative	Black	EA
N12PTS	1 & 2	Positive	Black	EA
N10NTS	1/0	Negative	Black	EA
N10PTS	1/0	Positive	Black	EA
N20NTS	2:0	Negative	Orange	AC
N20PTS	2:0	Positive	Orange	AC
N30NTS	3:0	Negative	Purple	AB
N30PTS	3:0	Positive	Purple	AB
N40NTS	4:0	Negative	Yellow	AA
N40PTS	4:0	Positive	Yellow	AA

flags

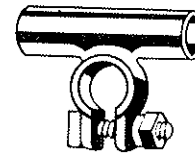

CATALOG NO.	CABLE SIZE	POLARITY	COLOR DIE CODE	LETTER DIE CODE
N20NTF	2:0	Negative	Orange	AC
N20PTF	2:0	Positive	Orange	AC
N30NTF	3:0	Negative	Purple	AB
N30PTF	3:0	Positive	Purple	AB

left elbows



CATALOG NO.	CABLE SIZE	POLARITY	COLOR DIE CODE	LETTER DIE CODE
N20NTLE	2:0	Negative	Orange	AC
N20PTLE	2:0	Positive	Orange	AC

right elbows



CATALOG NO.	CABLE SIZE	POLARITY	COLOR DIE CODE	LETTER DIE CODE
N20NTRE	2:0	Negative	Orange	AC
N20PTRE	2:0	Positive	Orange	AC

HEAVY WALL HEAT SHRINK TUBING

- **Heavy wall polyolefin** material assures superior abrasion protection and strain relief

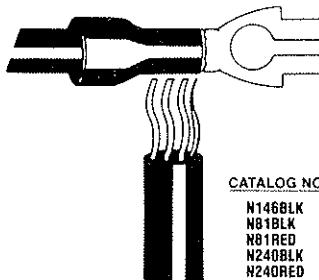

- **Meltable white adhesive** seals out moisture and air, thereby preventing corrosion and providing a watertight seal.

- **3 to 1 shrink ratio** allows fewer part numbers to cover a variety of cable sizes resulting in less inventory.

CATALOG NO.	WIRE RANGE	COLOR	MAXIMUM WALL	PRE-SHRINK	POST SHRINK	LENGTH
			THICKNESS	I.D.	I.D.	
N146BLK	14-6 GA	Black	060	400	150	6"
N81BLK	8-1 GA	Black	095	750	250	6"
N81RED	8-1 GA	Red	095	750	250	6"
N240BLK	2 GA -4:0	Black	120	1 100	375	6"
N240RED	2 GA -4:0	Red	120	1 100	375	6"

ELECTRICAL SUPPLIES

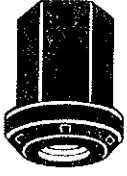

STUD TOP BATTERY NUTS

- **Color coded** tough synthetic material or stainless steel design available.
- **Synthetic material** design weighs just a fraction of stainless steel nut.

CATALOG NUMBER	COLOR	DESCRIPTION	POLARITY
NBNBLK	Black	Synthetic Nut	Negative
NBNRED	Red	Synthetic Nut	Positive

Tighten nuts to 150 inch pounds



STARTER LUGS

- Flared entrance for easy cable insertion
- Highest grade electrolytic copper provides a low resistance connection.
- Fully annealed for crimping with standard tools or can be soldered.

CATALOG NO.	WIRE SIZE	STUD SIZE	BARREL I.D.	LENGTH	WIDTH OF PAD
N414SL	4	1/4	.286	1.50	.525
N438SL	4	3/8	.286	1.50	.525
N214SL	2	1/4	.336	1.62	.615
N238SL	2	3/8	.336	1.62	.615
N114SL	1	1/4	.360	1.72	.665
N138SL	1	3/8	.360	1.72	.665
N112SL	1	1/2	.360	1.72	.665
N1038SL	1:0	3/8	.407	1.86	.735
N1012SL	1:0	1/2	.407	1.86	.735
N2038SL	2:0	3/8	.461	2.08	.815
N2012SL	2:0	1/2	.461	2.08	.815
N3038SL	3:0	3/8	.511	2.16	.905
N3012SL	3:0	1/2	.511	2.16	.905



UNIVERSAL CRIMPING TOOL

- **Double compound action** effortlessly exerts maximum force for fast, reliable crimps time after time.
- **Rotating dies** accommodate all sizes of battery terminals, lugs and connectors eliminating loss or need to store individual dies.
- **Diamond shape crimp** compresses all strands together to form a solid mass of copper. This assures a low resistance connection every time.
- **Easy to use** reference chart located on tool eliminates guess work enabling competitive products to be crimped accurately.

CATALOG NO.	WEIGHT	HEIGHT	WIRE RANGE
N283CT	7 lbs.	25 inches	#8 GA. - 250 MCM

ELECTRICAL SUPPLIES

UTILITY TYPE ROUND SEALED BEAMS

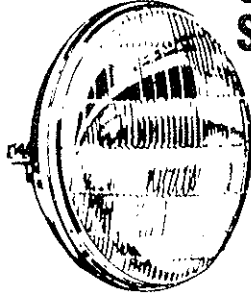

P4416
P4537
P4412A (Amber)

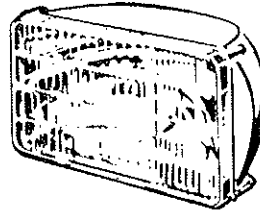

HALOGEN SEALED BEAMS

The most advanced headlights ever developed. High beam headlights produce twice as much candle power as conventional headlights without consuming extra energy.

ROUND	SQUARE
PH6017 replaces 6014	PH4651 replaces 4651
PH5001 replaces 4001	PH6054 replaces 6052
PH5006 replaces 4000	PH4656 replaces 4652
	PH4701 Hi Beam
	PH4703 Lo Beam
	PH4666 Hi/Lo Beam

STANDARD AUTOMOTIVE SEALED BEAMS

ROUND	SQUARE
P4000	P4651
P5001	P4652
P6014	P6052
P6015	

Plastic Halogen Sealed Beams

PHP4651 Square
PHP4656 Square
PHP6054 Square

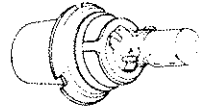

Replaceable Halogen Bulb Assembly

Serves most current aerodynamically headlighted vehicles. Because of the size of these replacement capsules, one can be carried in the glove box. It's like carrying a complete, spare headlight in the vehicle.

PH9004

PH9005

PH9006



MINIATURE LAMPS

PDE3022	P90	P212	P912	P1157NA	P2357NA
PDE3175	P97	P222	P921	P1295	P2456
PPR2	P97A	P224	P922	P1295NA	P2457
PPR3	P105	P323	P936	P1445	P2457NA
P24	P158	P550	P1003	P1815	P2458
P24NA	P161	P552	P1004	P1816	P2458NA
P37	P168	P561	P1034	P1891	P7152
P53	P194	P562	P1073	P1893	
P57	P194A	P563	P1141	P1895	
P67	P194NA	P570	P1155	P2033	
P73	P198	P631	P1156	P2057	
P74	P199	P658	P1157	P2057NA	
P89	P211	P907	P1157A	P2357	

ELECTRICAL SUPPLIES

LIGHT BULBS for Service Dept./Showroom Car Lot/Body Shop

Regular Frosted (TWREG)
75-100-150-200 Watt



Regular Clear (TWCB)
60 Watt

Rough Service (TWRS)
50-75-100 Watt



Rough Service Tough Skin (TWRSTF)
(Rubberized)
50-75-100 Watt

Outdoor Flood Light (TPARFL)
150 Watt



Infrared Heat Lamp
250 Watt
X22021



Fluorescent



TF40-CW double pin
40 Watt Cool White 48" Long

TF40D double pin
40 Watt Day Light 48" Long



TF96T12CW single pin
15 Watt Cool White 96" Long



TF96T12CWSHO
110 Watt Cool White 96" Long
Super Hi Output

PIGTAIL SOCKET ASSEMBLIES W/16 GAUGE/10" WIRE LEADS

The pigtail socket assemblies are not supplied separately by the factories only as part of the entire electrical wire harness. The socket assemblies locking tabs are vulnerable during removal and also the sockets can be damaged in the front end collision.

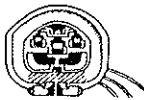

J87-6233

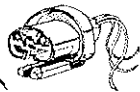

J87-6234

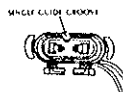

J87-6235

SEALED BEAM CONNECTORS

- Bronze contacts for dependability.
- Tough, molded bakelite housing.
- Three 14 gauge insulated copper wire leads, 8" long.

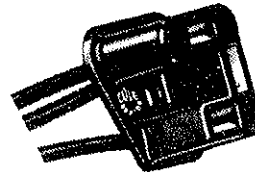

No. T3029 Triple contact

S & S Part No.	APPLICATION	QTY
J87 6233	For 9004 Bulb 3 Prong	5/PKG
J87 6234 (w/seal)	For 9005 Bulb 2 Prong	5/PKG
J87 6235 (w/seal)	For 9006 Bulb 2 Prong	5/PKG

ELECTRICAL SUPPLIES

PAL AUTO LINK FUSES

PAL — designed to effectively protect the car's wiring system. PAL is capable of withstanding high levels of current and high temperatures for extended periods by matching the fuse's characteristics with the automotive cable's thermal insulation rating.

<u>PART NO.</u>	<u>AMP RATING</u>	<u>COLOR</u>	<u>TERMINAL STYLE</u>
TPAL030	30	Pink	Female
TPAL040	40	Green	Female
TPAL060	60	Yellow	Female
TPAL130	30	Pink	Male
TPAL160	60	Yellow	Male
TPAL180	80	Black	Male
TPAL230	30	Pink	Bent
TPAL240	40	Green	Bent
TPAL270	70	Brown	Bent

STYLES & DIMENSIONS

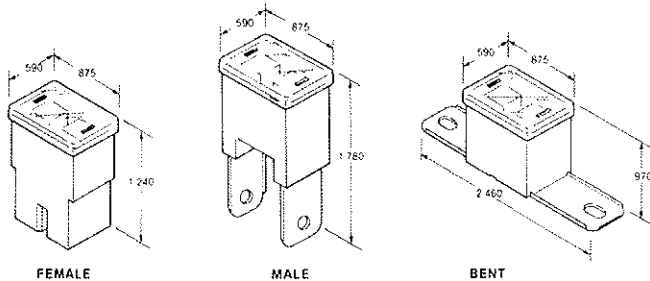

AUTOMOTIVE GLASS FUSES

DIRECT FACTORY REPLACEMENTS FOR DOMESTIC AND IMPORT CARS AND TRUCKS, RECREATIONAL VEHICLES, MOTORCYCLES AND MARINE EQUIPMENT

Note: Numerals indicate amperage. Example: AGA 1 is a 1 amp fuse, AGA type.

TAGA Fuses

TAGA 2
TAGA 3
TAGA 5
TAGA 7½
TAGA 10
TAGA 15
TAGA 20
TAGA 30

TAGW Fuses

TAGW 4
TAGW 15
TAGW 20
TAGW 30

TSFE Fuses

TSFE 4
TSFE 6
TSFE 7½
TSFE 9
TSFE 14
TSFE 20
TSFE 30

Import Car

TGBC Fuses

TGBC 5A
TGBC 8A
TGBC 16A
TGBC 25A

TAGC Fuses

TAGC 1
TAGC 2
TAGC 2½
TAGC 3
TAGC 4
TAGC 5
TAGC 7½
TAGC 10
TAGC 15
TAGC 20
TAGC 25
TAGC 30
TAGC 35

TAGX

TAGX 20
TAGX 30



AGA
TSFE4
(¼" x 5/8")



TAGC
SFE20
(¼" x 1¼")



AGW
TSFE7½, SFE9
(¼" x 7/8")

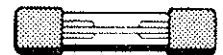

TSFE14
(¼" x 1 1/16")



TSFE6
(¼" x ¾")

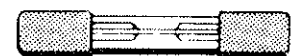

AGY
TSFE30
(¼" x 1 7/16")

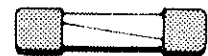

TAGX
(¼" x 1")



TGBC5,8,16,25
(25x6mm)

ACTUAL SIZE

ELECTRICAL SUPPLIES

ATOFUSES

Revolutionary New Fuse
Developed by LITTLEFUZE

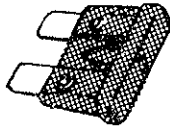

A completely new concept in automotive fusing, the Autofuse is original equipment on several late model automobiles. It's smaller, more compact, easy to remove and install, and color-coded for quick identification.

TATO 3	TATO 15
TATO 4	TATO 20
TATO 5	TATO 25
TATO 7½	TATO 30
TATO 10	

Dealer Service Kit

Assortment of 100 fuses:

5-AT03
10-AT0 5
5-AT0 7½
20-AT0 10
5-AT0 15
35-AT0 20
15-AT0 25
5-AT0 30

Part No.
T094201



ATO In Line Fuse Holder

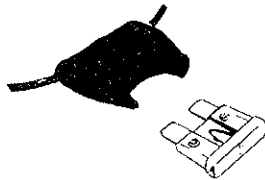

New in-line fuse holder for use with ATO 3, 5, 7½, 10, 15, 20, 25 and 30 amp fuses. Supplies with 8" loop of 16 gauge wire. **TFHA2**

Universal In-Line Fuse Holder Display

Nylon in-line fuse holders - mounted 12 to a card. Holder is supplied with 8" loop of 14 gauge wire and two springs AGA, AGW, and AGX fuses.

Card size: 10" x 15"
Fuses Not Included

T094103

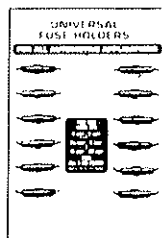

CERAMIC FUSES

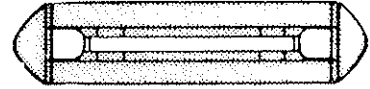

VW, Porsche, Mercedes, Opel, Fiat, Renault. Standard Pkg., 10 per pkg., 100 per box

Part No.	Color	Amps
EN17-121-1	White	8
EN17-121-4	Red	16
EN17-121-5	Blue	25

Fuse Clip Type CIRCUIT BREAKERS

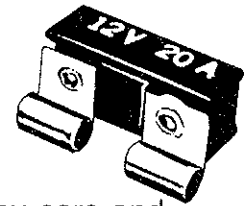

Original equipment on many cars and trucks. Direct replacements for fuses without physical alterations in the system. Provides convenience and reliability for auto, truck and bus circuit protection. One type fits both 1¼" and 7/8" fuse clips.

Part Number	Amperage
TCBF10	10
TCBF15	15
TCBF20	20
TCBF25	25
TCBF30	30

New Self-Stripping Fuseholder Cuts Installation Time and Cost

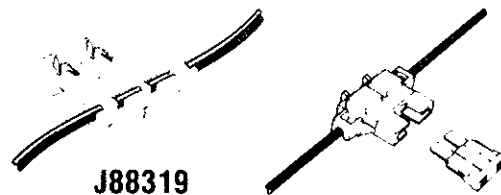

Heavy Duty 30 AMP In-Line Fuse Holder

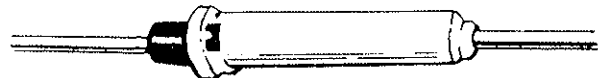

Supplied with two 4" leads - 12 gauge wire for 30 amp applications, including GM air conditioner and heater blower motors.

AGC 30 Amp Fuse Included With Each Holder **TFNY30**

ELECTRICAL SUPPLIES

The Littlefuse MAXI—FUSE ASSORTMENT

TFDR 20

CONTENTS	
20 Maxi™ Fuses	
Qty.	Part No.
2	MAX 20
4	MAX 30
6	MAX 40
2	MAX 50
6	MAX 60

Littlefuse's major breakthrough in automotive circuit protection technology that protects the car's wiring system from damage.

THE MINI® FUSE *by Littelfuse*

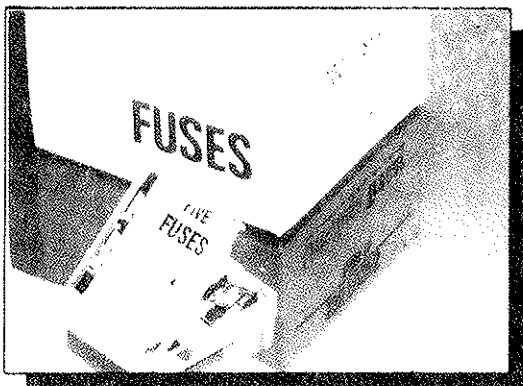

PART NO.	DESCRIPTION
TMIN2	2 AMP
TMIN3	3 AMP
TMIN4	4 AMP
TMIN5	5 AMP
TMIN75	7½ AMP
TMIN10	10 AMP
TMIN15	15 AMP
TMIN20	20 AMP
TMIN25	25 AMP
TMIN30	30 AMP
TFDR100	Mini Fuse Assortment

ELECTRICAL SUPPLIES

HEAVY DUTY - FLASHERS

Tested to appropriate SAE specifications.
Tested for start time, voltage drop,
flash rate and percent
current on time.

Part Number
P552

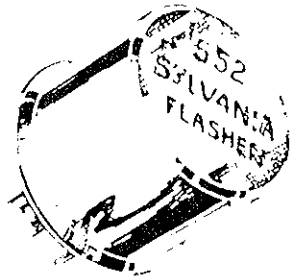

Electrical Tape

Flame retardant, cold
and weather resistant
P.V.C. insulating tape.
UL listed complying
with CSA standards.

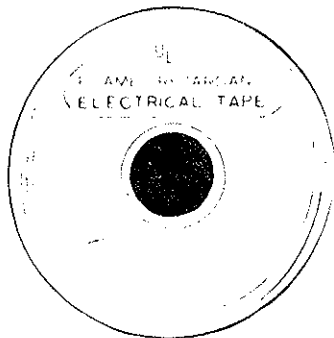

TUL33 3/4" x 33ft.
TUL66 3/4" x 66ft.



SCOTCH Electrical Tape

- Specifically designed for auto repairs
- Excellent for splicing wires, harnessing cable, wrapping hoses, and more

PART NO.	SIZE	ROLLS/ BOX	ROLLS/ CASE
T6100	3/4" x 20 ft.	10	100
T6101	3/4" x 60 ft.	10	100
T6102	3/4" x 60 ft.	10	100
T6133	3/4" x 52 ft.	10	100

WIRE LOOM Split Flexible Tubing



TSL1000 - 1" I.D.
TSL350 - 1/4" I.D.
TSL500 - 1/2" I.D.

Order per foot in 10 ft. increments.

SCOTCH Auto-Electric Sealing Compound (Patches)

SCOTCH Brand Auto-Electric Sealing Compound is now available in 2 1/2" x 2 1/2" patches. These patches can be used in place of tape to give connections all season/all weather protection and applies in less time. The tough vinyl backing prevents abrasion and protects against all common auto elements. In addition to providing a moisture-proof barrier for connections, these patches can be used for wire repair, sealing lights and protecting terminal blocks.

PART NO.	SIZE	PATCHES PER BOX	BOXES PER CASE
T6149	2" x 2"	25	10

ELECTRICAL SUPPLIES

PETERSON LIGHTING

ROUND QUICK MOUNT REFLECTOR

Adhesive backing permanently mounts reflector to any clean, flat surface. 3" diameter acrylic lens.

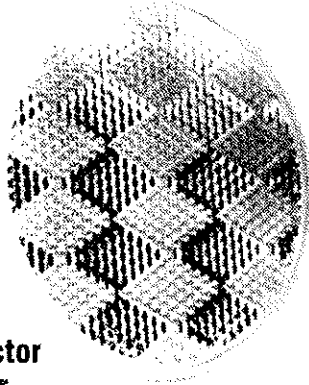

PB475A Amber Reflector
PB475R Red Reflector

OBLONG QUICK MOUNT REFLECTOR

Adhesive backing permanently mounts reflector to any clear, flat surface.

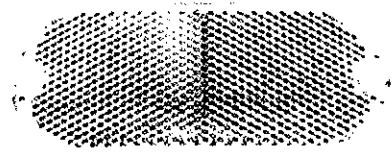

PB480A Amber Reflector
PB480R Red Reflector

CENTER MOUNT REFLECTOR

3" diameter reflector hermetically sealed in a protective plastic cup. Reflector mounts with one screw through center hole.

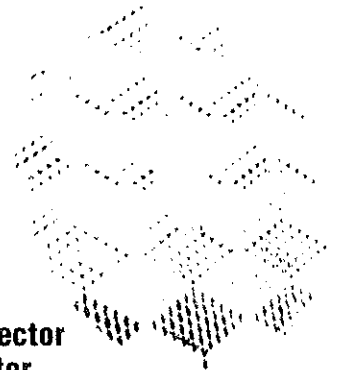

PB486A Amber Reflector
PB486R Red Reflector

MINI-LITE P107WA

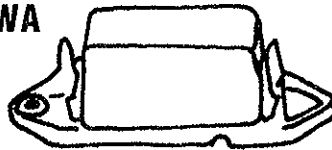

A gem of miniaturization; unbelievably compact yet packed with quality features. Base has external mounting holes with 2³/₄" centers. Acrylic lens locked into base, cannot be knocked out by tree limbs, etc. Overall length 3¹/₄"; width 1"; height 1¹/₈". With amber lens.

DOME LIGHT WITH SWITCH P390S

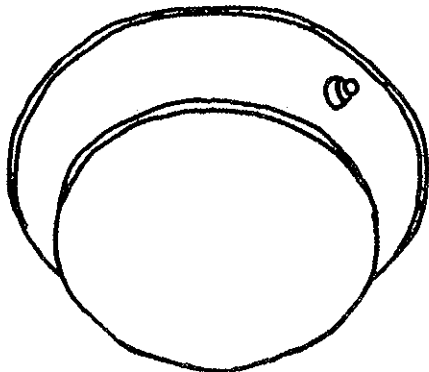

Flexible polyethylene lens ideal for high-impact area usage. Lens is virtually indestructible. Push type on/off switch. Housing made to accommodate separate ground wire for installation on non-conductive surfaces. Lens diameter 4¹³/₁₆"; housing diameter 6⁵/₁₆"; height 2".

REPLACEMENT LENS

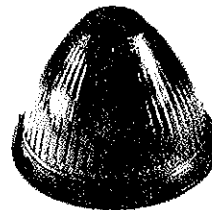

P11015R Red



P13815R Red

ELECTRICAL SUPPLIES

STOP/TAIL LIGHT P3122



Pedestal Mount. Corrosion proof Lexan housing with extra large 4 13/16" diameter acrylic snap-on lens. Vibar socket protects bulb from road shock and vibration, greatly extending bulb life. Plated hollow mounting bolt mounts in 7/16" hole.

TURN SIGNAL 2-WIRE P3122RA



Double face Lexan housing with 4 13/16" diameter snap-on lens. Hollow mounting bolt requires 7/16" hole. With a double filament 32/3 c.p. bulb for use as a combination parking and turn signal light.

TURN SIGNAL P326

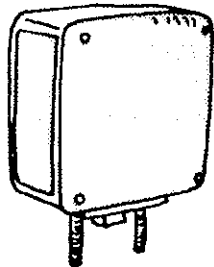

Double face turn signal with side marker light and reflector. Plug-in receptacle at base accepts OEM harness. Vibar socket eliminates premature bulb failure.

COMPLETE SEALED LAMP KIT P426KR

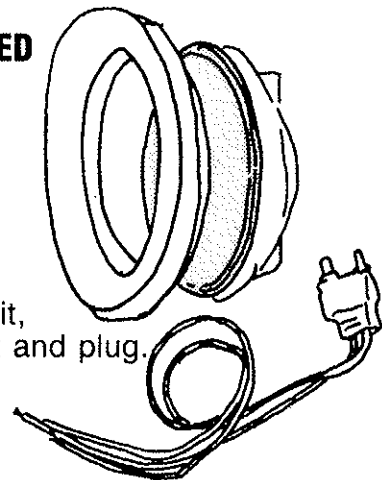

Includes a double filament sealed unit, mounting grommet and plug.

REFLECTOR TAPE P465

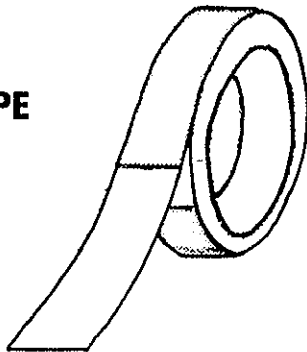

Red/Silver alternate tape. Microprismatic reflective tape has 160 times magnification of ordinary glass bead reflective sheeting. This results in:

- 4 times greater reflectivity
- wider viewing angles
- higher visibility at long and greater range
- tougher durability

Available in 150 foot rolls.

SEALED STOP/TAIL LIGHT P426R



Housing and lens are permanently sealed to eliminate corrosion. The bulb is cradled in a Vibar II Socket which literally floats the bulb filaments soaking up road shock and vibration. It has a completely weather-tight electrical connection. With red lens.

ELECTRICAL SUPPLIES

HUPPY LITE MATE® PRODUCT SELECTION GUIDE THE COMPLETE VEHICLE-TO-TRAILER WIRING SYSTEM

**NO MORE SPLICING,
STRIPPING OR TAPING.
LITE MATE TAKES THE
WORK OUT OF WIRING A
TRAILER TO ANY CAR,
TRUCK OR VAN... BOTH
IMPORT AND DOMESTIC.**

**HERE'S HOW LITE MATE®
SIMPLIFIES TRAILER WIRING.**

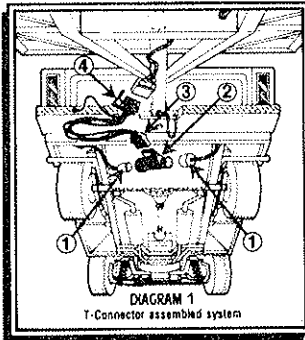

Diagram 1 shows how Lite Mate® works on trucks that have a plug-in taillight connection... usually located just behind the rear bumper. All you do is unplug that connector (1) and plug the Lite Mate® "T" Connector (2) into the circuit. Then, a Lite Mate® Trailer Wiring Harness (3), that matches the trailer, is plugged into the "T" Connector and into the trailer (4). The wiring is now complete. It's that simple!

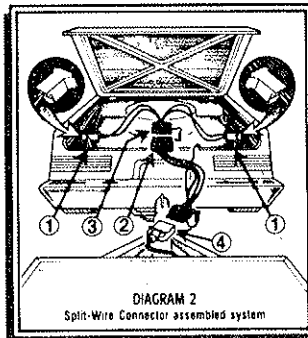
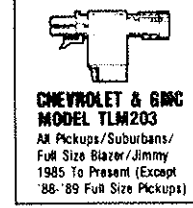
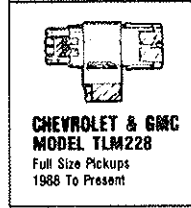
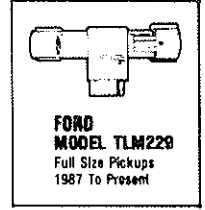
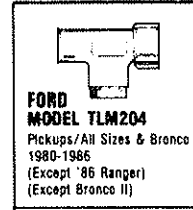
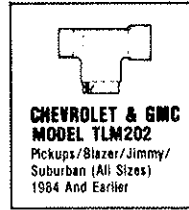
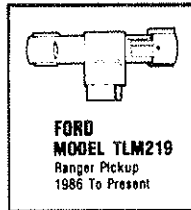
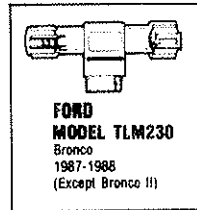
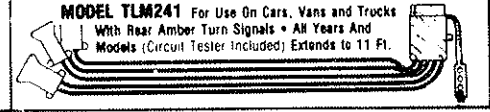
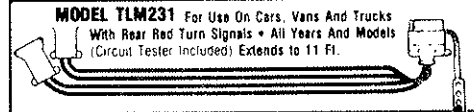

Diagram 2 shows how Lite Mate® works on vehicles without the plug-in taillight connection. Two types of Lite Mate® Split-Wire Connectors are made available for these vehicles. The 4-Wire Connector is used for all vehicles with red turn signals and a 5-Wire Connector is used for all vehicles with amber turn signals. With the circuit tester included in each package, lighting system wires are identified and placed into marked channels (1) on the Split-Wire Connector. The outer shell is then slipped into position to complete the circuit. A Lite Mate® Trailer Wiring Harness (2) is plugged into the Split-Wire Connector (3) and then into the trailer (4). Trailer wiring is now complete.



SPLIT WIRE CONNECTORS / For Use With All Vehicles (Import & Domestic) Not Listed Above



TRAILER WIRING HARNESSSES / For Use With T-Connectors Or Split Wire Connectors Listed Above

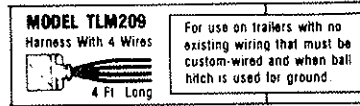
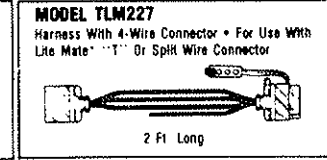
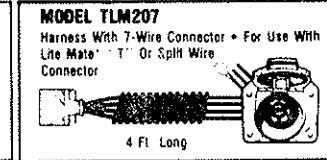
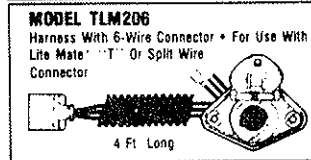

MOLDED WIRING HARNESS

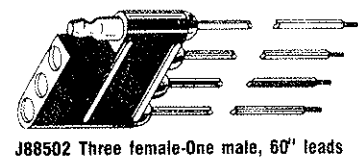
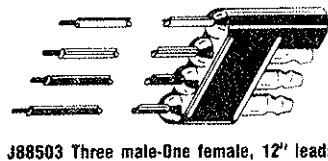

J88501 Above sold as a pair (J88503 & J88502)

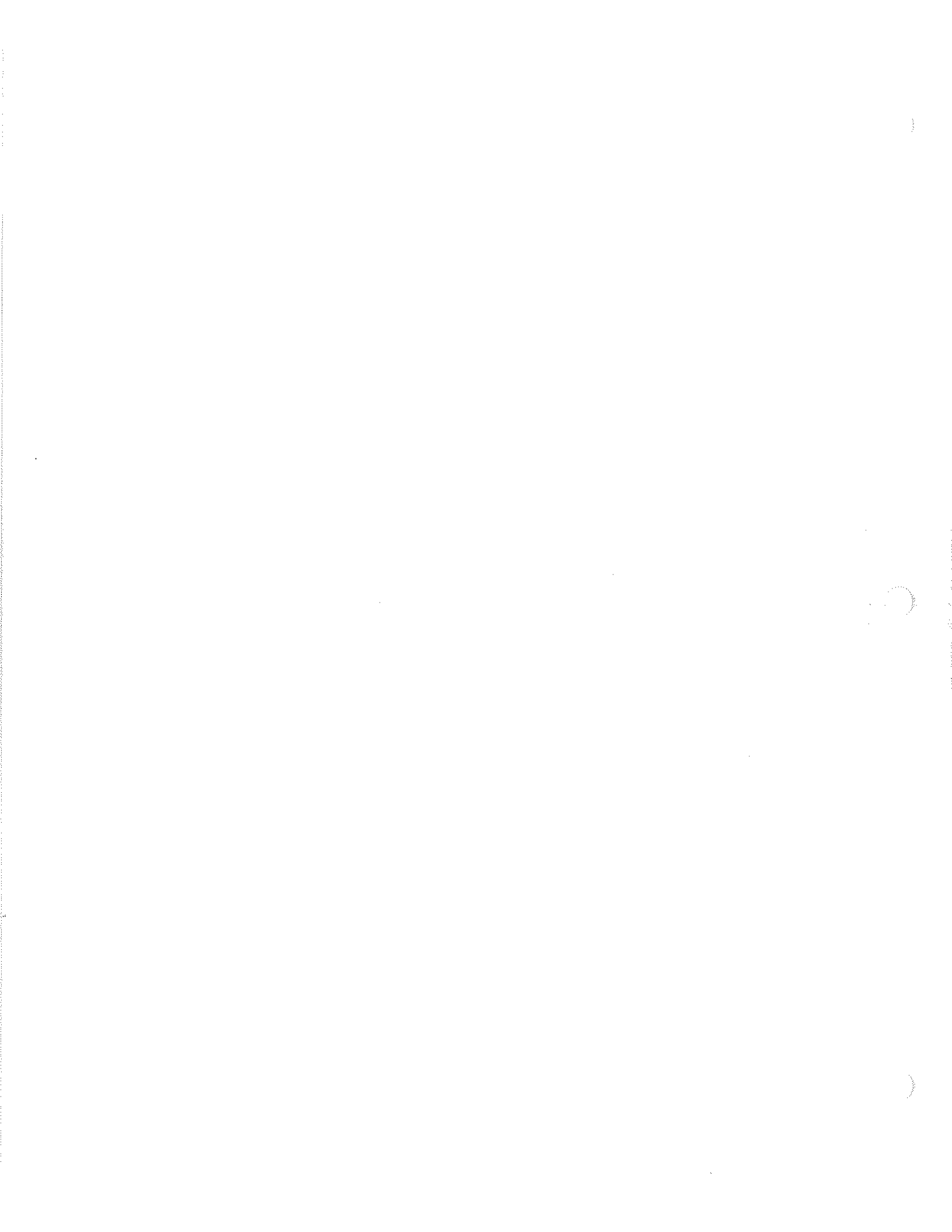

GENERAL MERCHANDISE

SECTION 5

	PAGE
AIR REGULATOR.....	17
ALIGNMENT ASSORTMENTS.....	5-8
ALIGNMENT TOOLS.....	6
ANTI-FREEZE TESTER.....	24
ANTI-SLIP SAFETY WALK.....	50
ANTISEPTICS.....	43
APPLICATOR GUNS.....	30
APRON.....	45
ASPIRIN.....	43
ATOMIZER.....	42
BANDAIDS, BANDAGES.....	43
BARREL PUMPS.....	27
BATTERY CHARGER.....	31
BATTERY FILLER.....	23
BATTERY TESTER.....	24
BEEF CLOTH.....	39
BLO GUNS.....	12
BODY SHIMS.....	9
BOOTS.....	45
BRAKE FLUID PUMP.....	27
BRAKE LATHE BITS.....	2
BRAKE LINES.....	2
BROOM HANDLES.....	36
BROOMS-HOUSE, FLOOR, GARAGE, STREET.....	37
BRUSHES:	
Acid.....	36
Detail.....	35
Fountain.....	35
Grille.....	34
Hand.....	35,36
Paint.....	36
Parts.....	34
Scrub.....	35,36
Snow.....	34
Toilet.....	41
Wash.....	35
Wheel.....	35
Whitewall.....	35
Windshield.....	34
Wire.....	25,34,36
Wire Wheel.....	35
BUCKETS.....	38
BUFFER-POLISHER.....	29
BUFFING PADS.....	29,30
BUFFING PAD WASHER.....	29

BUG SPONGE.....	39
BUMPER JACK.....	9,28
BUNGE CORDS.....	23
CABINET.....	32
CAN LINERS.....	44
CAR WASH MOP.....	38
CARBURETOR SPRINGS.....	24
CARTRIDGE GUNS.....	30
CASTER CAMBER SHIMS.....	6-9
CAULK GUN.....	30
CHAMOIS.....	39
CHARGERS.....	31
CLEAN AND STRIP DISCS.....	50
CLEANING MITTS.....	39
CONTAINER-5 GAL. POLY.....	41
COOLANT TESTER.....	24
COPPER TUBING.....	2
CREEPER.....	26
CUPS-STYROFOAM.....	40
CUTTING SHEARS.....	30
DEODORANT BLOCKS.....	40
DISPENSERS, PAPER.....	40
DISPENSING RACK.....	41
DISPOSABLE TOWELS.....	39,40
DOUBLE END DRILL BITS.....	26
DRAIN PANS.....	21
DRILL BIT ASSORTMENTS.....	26
DRILL BITS.....	26
DRUM PUMPS.....	27
DUST PANS.....	37
EXHAUST HOSE.....	18
EXHAUST HOSE ADAPTORS/HARDWARE.....	18
FABRICUT ROLLS.....	47
FACE SHIELD.....	43
FACIAL TISSUES.....	40
FENDER COVERS.....	23
FIRE EXTINGUISHERS.....	43
FIRST AID KITS.....	43
FIRST AID SUPPLIES.....	43
FLAT FIX.....	28
FLOOR SQUEEGEE.....	38
FLUSHING MACHINE.....	31
FLUSHING TEE'S.....	23
FUNNELS.....	22
GARBAGE BAGS.....	44
GARBAGE CANS.....	44
GAS CANS.....	23
GASKET CLEANING DISCS.....	49,50
GLOVES.....	45
GOGGLES.....	43
GREASE FITTINGS.....	20
GREASE GUNS.....	27
HACKSAW BLADES.....	25
HAND TRUCK.....	27

HANDLE BRACE.....	36
HANDLES-BROOM/SQUEEGEE	36
HANGAR BAR.....	19
HEAT GUN.....	30
HEAT GUN ELEMENTS.....	30
HOLE CUTTERS.....	26
HOOK N LOOP.....	48
HOSE CLAMPS.....	17
HOSE CLAMP RACK.....	17
HOSE HARDWARE:	
Air Hose.....	10,16
Couplers	14,15
Dispenser	16
Exhaust.....	18
Fittings.....	13
Fuel Injection Hose.....	16
Fuel Line Hose.....	16
Heater Hose.....	16
Hose Ends.....	13
Hose Ferrules.....	17
PCV Hose.....	16
Re-Koil Air Hose.....	10
Repair Kit.....	10
Swivel.....	15
Washers	10
Water Hose.....	16
Water Nozzle.....	13
Wiper Hose.....	16
HYDRAULIC JACK.....	31
ICE SCRAPERS.....	34
JACK STANDS.....	28
JACKS-BUMPER/SCISSORS.....	9,28
JACKS-HYDRAULIC.....	31
KNIFE-UTILITY.....	33
KWIK START.....	31
LIFT DRAIN.....	21
MARKING CRAYONS.....	4
MECHANIC'S WIRE.....	23
MOP BUCKETS.....	38
MOP HANDLES.....	38
MOP HEADS.....	38
MOP WRINGERS.....	38
MUFFLER CEMENT.....	19
MUFFLER CLAMPS.....	18
MUFFLER HANGARS.....	19
MUFFLER HARDWARE.....	19
OIL DISPENSERS.....	21
OIL DRAIN.....	21
OIL DRAIN CASTERS.....	21
OIL FILTER WRENCH.....	22
OIL MEASURE.....	22
OILY RAG CAN.....	22

ORBITAL BUFFER.....	29
ORBITAL POLISHER.....	29
ORBITAL WAXER.....	29
PAD CLEANER.....	30
PAD WASHER.....	29
PAILS.....	38
PAPER BAGS.....	40
PAPER TOWELS.....	39,40
PARTS BRUSH.....	34
PLUMBERS TAPE.....	19
POLISHER.....	29
POLISHING CLOTH.....	39
POLISHING PADS.....	30
PROPANE TANK.....	25
RADIATOR FILLERS.....	23
RAZOR BLADES.....	33
RAZOR SCRAPERS.....	33
ROLL TOWELS.....	40
RUBBER APRON.....	45
RUBBER BOOTS.....	45
RUBBER GLOVES.....	45
SAFETY EQUIPMENT.....	43
SCISSORS JACK.....	9,28
SCOTCH BRITE DISCS.....	49,50
SCOTCH BRITE PADS.....	49,50
SCRAPERS.....	33
SHIMS.....	5-9
SHIM ASSORTMENTS.....	5-8
SHOP TOWELS.....	39,40
SNOW BRUSHES.....	34
SPONGES.....	39
SPRAY BOTTLES.....	42
SPRAYERS.....	42
SPRINGS.....	24
STORAGE CABINET.....	32
SURFACE CONDITIONING DISCS.....	49,50
SQUEEGEE'S.....	34,38
SQUEEZE BOTTLES.....	42
STEEL TUBING.....	2
STEEL WOOL.....	33
STYROFOAM CUPS.....	40
SUCTION GUNS.....	27
TAIL PIPE HANGERS.....	19
TANK CONVERSION KIT.....	13

TAPE:

Adhesive Transfer.....	48
Air Conditioning.....	46
Attachment.....	47
Box Sealing.....	46,48
Cloth.....	46,49
Dispensers.....	48,49
Duct.....	46
Electrical.....	46
Filament.....	46,48
Fine Line.....	46
Flat Black.....	48
Labelgard.....	48
Masking.....	46,47
Moulding.....	47
Packing Slip.....	49
Pipe Sealant.....	46
Plastic.....	47,48
Post It Removable.....	49
Removable.....	49
Teflon Sealant.....	46
Vinyl.....	47
TARP STRAPS.....	23
THROTTLE SPRINGS.....	24
TIRE CEMENT.....	4
TIRE CHUCKS.....	13
TIRE GAUGES.....	11,13
TIRE INFLATOR.....	9,13
TIRE MARKING CRAYONS.....	4
TIRE PATCHES.....	4
TIRE PLUGS.....	4
TIRE REPAIR TOOLS.....	4
TIRE VALVES.....	11
TIRE VALVE EXTENSIONS.....	11
TIRE VALVE TOOLS.....	10
TISSUES.....	40
TOILET TISSUE.....	40
TOWELS.....	39
TRASH CAN LINERS.....	44
TRASH CONTAINERS.....	44
TURKISH TOWELS.....	39
UNIBITS.....	26
URINAL BLOCKS.....	41
URINAL SCREENS.....	41
UTILITY KNIFE.....	33
UTILITY KNIFE BLADES.....	33
URINAL BRUSH.....	41
VELCRO-HOOK N LOOP.....	48
WAREHOUSE BROOMS.....	37
WASH MITTS.....	39
WASH MOPS.....	38
WASH TOWELS.....	39
WASTE BASKETS.....	44
WATER NOZZLE.....	13

WATER SPRITES.....	39
WEATHER STRIPPING.....	46
WELDING MASKS.....	43
WELDING SUPPLIES.....	43
WET FLOOR SIGN.....	38
WHEEL LUG NUT REMOVAL TOOL.....	5
WHEEL WEIGHTS.....	3
WHEEL WEIGHT TOOLS.....	3
WHISK BROOM.....	34
WINDSHIELD WIPES.....	39
WIPER BLADES.....	1
WIPER HOSE.....	1,16
WIPER REFILLS.....	1
WIPER/WASHER COUPLER.....	1
WIPER/WASHER TEE'S.....	1
WIPES.....	39
WIRE BRUSHES.....	25,34,36
WIRE WHEEL BRUSHES.....	25
WIRE WHEEL REMOVAL TOOL.....	5,6
WRINGER.....	28
ZERK FITTINGS.....	20

GENERAL MERCHANDISE



WIPER BLADES

TRICO BLADES

W33162	16"
W38160	16"
W33183	18"
W38180	18"

TRICO WINTER BLADES

W37150	15"
W37160	16"
W37170	17"
W37180	18"

TRICO EURO BLADES

W39160	16"
W39170	17"
W39180	18"

TRICO REFILLS

W41160	16"
W42160	16"
W41180	18"
W42180	18"
W41191	19"
W41201	20"

W99100	Wiper Display Rack
W99104	Wiper Display Hooks



WINDSHIELD WIPER HOSE

Windshield wiper and washer tubing is precision extruded to rigid ID/OD tolerances.

STIMSONITE

T3339	7/64" x 50'
T3340	5/32" x 50'
T3341	7/32" x 50'
T3338	3/32" x 50'

ANCO

W74216	1/8" x 50'
W74316	3/16" x 50'
W74416	1/4" x 50'

DORMAN

T506-007	7/64" x 100'
T506-009	5/32" x 50'
T506-010	7/32" x 50'

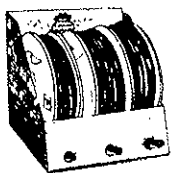

T015-090

Dispenser includes: 100 ft. spool of 7/64", 50 foot spools of 5/32" and 7/32" tube and box of each tee connectors T493007, T493009, and T493010.

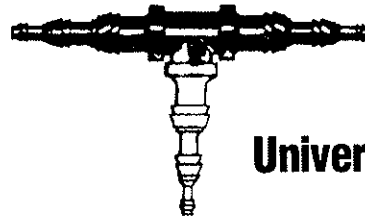

Universal Tee

Tee connectors are barbed to hold the hose—no clamps needed. Universal connectors fit three kinds of hose.

T493011 10/box



Universal Coupler

T493012 10/box

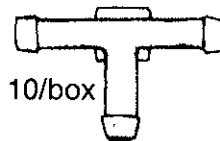

10/box

Washer Tee

T493007	7/64
T493009	5/32
T493010	7/32

GENERAL MERCHANDISE

DOUBLE WALL STEEL TUBING

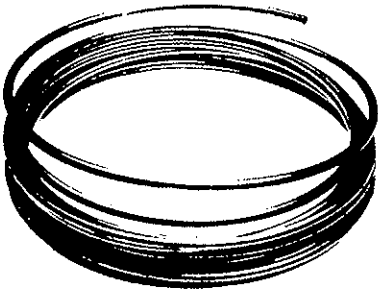

Double wall construction, copper fused and Terne coated. Original equipment on every car, bus and truck. Will meet or surpass S.A.E., U.S. Government and car factory specifications. "Annealed" for easy bending. Also resists kinking. WILL NOT RESTRICT FLUID FLOW. 25' coils.

- T11051 1/4" x 25'
- T11052 5/16" x 25'
- T11053 3/8" x 25'
- T11054 3/16" x 25'

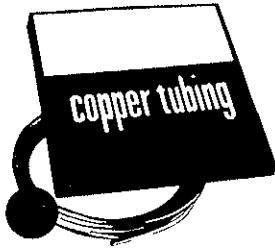

DORMAN COPPER TUBING

99.8% pure copper. Made to meet SAE specifications #J-528. 25 ft.

PART #	OUTSIDE DIAMETER	WALL THICKNESS
T2504	1/4"	.030
T2506	3/8"	.032

BRAKE LINE RACK

Durable, heavy duty metal rack designed to accommodate various sized brake lines.

T345



BRAKE LINES

Double wrapped, double flared, copper fused, tin coated brake lines. easy to bend. Double flared for greater resistance against vibration fatigue.

PART NO.	O. D. SIZE	STD. PKG.
TBL123	3/16" x 12"	6
TBL203	3/16" x 20"	6
TBL303	3/16" x 30"	6
TBL403	3/16" x 40"	6
TBL513	3/16" x 51"	6
TBL603	3/16" x 60"	6
TBL124	1/4" x 12"	6
TBL204	1/4" x 20"	6
TBL304	1/4" x 30"	6
TBL404	1/4" x 40"	6
TBL514	1/4" x 51"	6
TBL604	1/4" x 60"	6
TBL125	5/16" x 12"	6
TBL205	5/16" x 20"	6
TBL305	5/16" x 30"	6
TBL405	5/16" x 40"	6
TBL515	5/16" x 51"	6
TBL605	5/16" x 60"	6

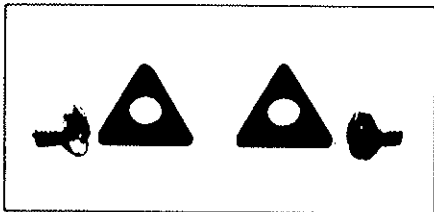

TTB12 FADE FREE CARBIDE TOOL BITS

Two, 6 Cutting-Edge Carbide Tool Bits for Drum and Disc Lathes

Can be used in place of Ammco's #6914

STEEL BRAKE LINES FOR IMPORTED CARS



LENGTH	BRITISH CARS 3/8-24 THREAD		EUROPEAN CARS 10-1.0MM THREAD	
	Order Number	Order Number	Order Number	Order Number
8"	SB308	J85980	SC308	J85970
12"	SB312	J85981		
20"	SB320	J85982		
30"	SB330	J85983	SC330	J85973
40"	SB340	J85984		
51"	SB351	J85985	SC351	J85975
60"	SB360	J85986	SC360	J85976

GENERAL MERCHANDISE

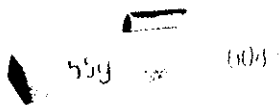

IMPORT ALLOY Wheel Weights

For Datsun Z Series, Toyota Celica Series, Mercedes Benz, BMW and Porsche O.E.M. aluminum wheels. 25/box

PART NO.	gr.	oz.	PART NO.	gr.	oz.
TIAW010	10	1/4	TIAW040	40	1 3/8
TIAW015	15	1/2	TIAW045	45	1 1/2
TIAW020	20	3/4	TIAW050	50	1 3/4
TIAW025	25	7/8	TIAW055	55	2
TIAW030	30	1	TIAW060	60	2 1/4
TIAW035	35	1 1/4			

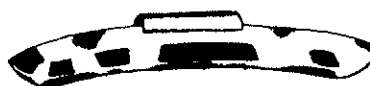

REGULAR Wheel Weights

For use on all passenger car rims with 13" 14", or 15" wheel covers

PART NO.	SIZE	QTY	PART NO.	SIZE	QTY
TP25	1/4 oz.	50	TP250	2 1/2 oz.	50
TP50	1/2 oz.	50	TP275	2 3/4 oz.	50
TP75	3/4 oz.	50	TP300	3 oz.	50
TP100	1 oz.	50	TP325	3 1/4 oz.	25
TP125	1 1/4 oz.	50	TP350	3 1/2 oz.	25
TP150	1 1/2 oz.	50	TP375	3 3/4 oz.	25
TP175	1 3/4 oz.	50	TP400	4 oz.	25
TP200	2 oz.	50	TP450	4 1/2 oz.	25
TP225	2 1/4 oz.	50	TP500	5 oz.	25



ALLOY Wheel Weights

For various styled custom alloy wheels, incorporating rim flanges. 50/box

PART NO.	SIZE	PART NO.	SIZE
TAW025	1/4 oz.	TAW175	1 3/4 oz.
TAW050	1/2 oz.	TAW200	2 oz.
TAW075	3/4 oz.	TAW225	2 1/4 oz.
TAW100	1 oz.	TAW250	2 1/2 oz.
TAW125	1 1/4 oz.	TAW275	2 3/4 oz.
TAW150	1 1/2 oz.	TAW300	3 oz.



LIGHT TRUCK Wheel Weights

Used on light duty trucks—1/2 and 3/4 ton—and recreational vehicles with either tube type or tubeless rims where such rims are too thick for passenger weights.

PART NO.	SIZE	QTY	PART NO.	SIZE	QTY
TLT1-1	1 oz.	25	TLT1-4	4 oz.	25
TLT1-2	2 oz.	25	TLT1-5	5 oz.	25
TLT1-3	3 oz.	25	TLT1-6	6 oz.	25



AWN SERIES Coated Wheel Weights

Applications-All Chrysler products, all General Motor products through 1988 except late model 16" Trans Am and 17" Corvette wheels. All Ford products 1975 through 1979. Most models 1980 through 1983. Also fits many major aftermarket manufacturers 13", 14", 15" and 16" passenger car alloy wheels.

TAW025N	TAW100N	TAW175N	TAW250N
TAW050N	TAW125N	TAW200N	TAW275N
TAW075N	TAW150N	TAW225N	TAW300N

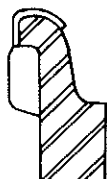

MCN SERIES Coated Wheel Weights

Applications-Ford products 1979 and later Mustang and Capri with TRX suspension (metric alloy wheels). 1980 and later Cougar and T-bird with TRX suspension (metric alloy wheels). All 1984 and later Ford products with alloy wheels. Also fits Hyundai vehicles equipped with alloy wheels.

TMC025N	TMC100N	TMC175N	TMC250N
TMC050N	TMC125N	TMC200N	TMC275N
TMC075N	TMC150N	TMC225N	TMC300N

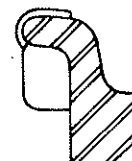

INSTALLATION TOOL - T75K

Unique "soft head" design facilitates the installation of coated weights without damaging the coating. Rear mounted clip claw quickly removes old weights. A must have tool for coated wheel weights.

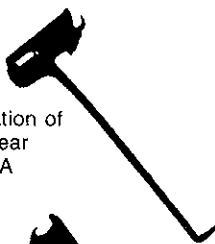

INSTALLATION TOOL - TPT7

Designed by mechanics for mechanics. "Clip Claw" design ideal for removing foreign and domestic weights. Extra heavy hammer enables you to install large weights. Plastic coated handles provide a better grip and insulation.



MC SERIES Uncoated Wheel Weights

Except for coating, the design and application are identical to the MCN Series. These are an economical alternative to OEM quality coated design. We recommend that coated weights be used on vehicles manufactured after 1985. Also fits 3/4 ton, 16x6 steel wheels with curved flange.

TMC025	TMC100	TMC175	TMC250
TMC050	TMC125	TMC200	TMC275
TMC075	TMC150	TMC225	TMC300

GENERAL MERCHANDISE

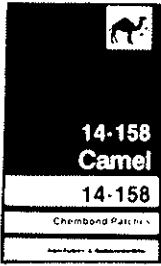

CAMEL Tire Patches

New No.	Qty.	Type	Size
T15-152	40	Sm.Rd	1-5/8" dia.

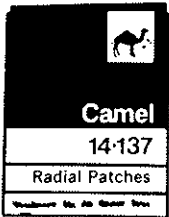

CAMEL Radial Tire Patches

New No.	Qty.	Type	Size(dia.)
T14-137	30	Sm.Rd.	2-1/4"
T14-139	20	Med.Rd.	3-1/8"

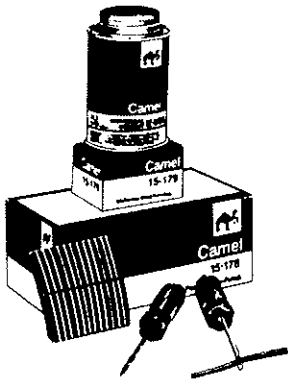

CAMEL Tire Patch Kit

T15-178 Kit contains 50 Perma Strips, One No. T15-212 probe, 1 can of No. T12-086 Universal cement, 1 No. T15-210 inserting needle, and free bonus pack of 20 patches.

T15-179 Box contains fifty 1/4" x 2" small Perma strip patches.



CAMEL Tire Buffing Cone

Used for preparing tire inner tubes for patches.

T17240



TYLER Plug Gun T100

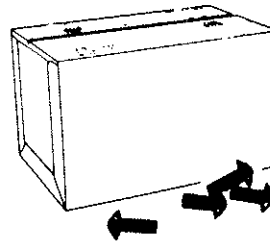

Regular Tire Plugs

T38	3/8"
T516	5/16"
T716T	7/16"



Tire Probe

Tire probe used for removing foreign matter from tubeless tires.

T15174



Universal Cement

Used on tires and tubes, heavy-duty strength adhesion.

T12086

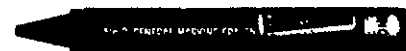

MARKING CRAYONS

Multi-purpose, non-smudging, waterproof. 12/box.

T11B	Black
T11W	White
T11Y	Yellow

GENERAL MERCHANDISE

WIRE WHEEL HUBCAP AND LOCKING LUG NUT REMOVER KIT

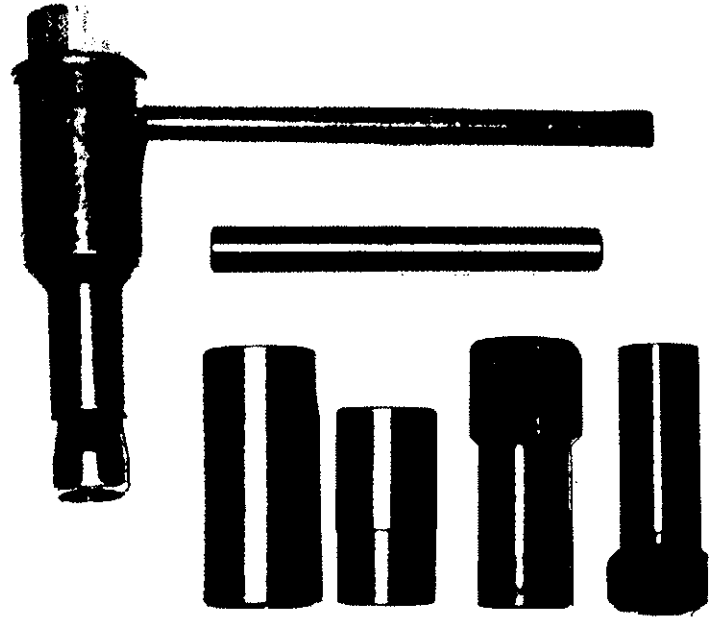
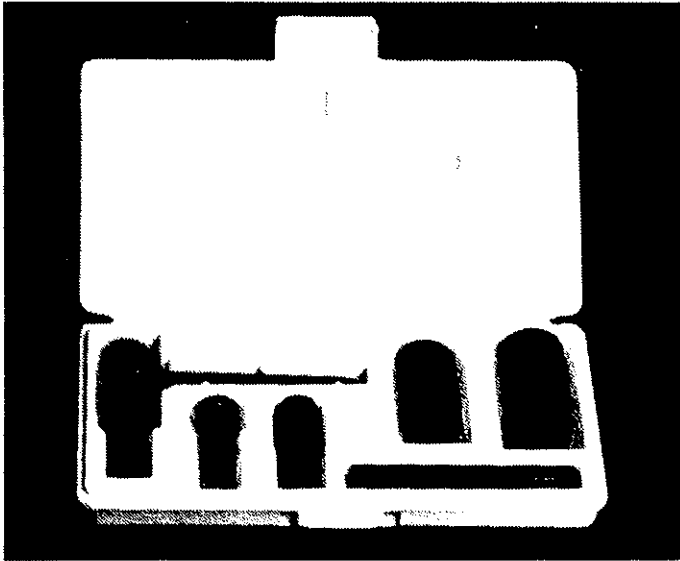

Safely removes GM, Ford, Chrysler wire wheel hubcap locks 1978 - 1988 models. Also removes factory and most after market McGard mag wheel locking lug nut locks.

T882500

PERFECT EQUIPMENT

REAR WHEEL FULL CONTACT SHIM MASTER ASSORTMENT (Part Number 15290)

This comprehensive assortment contains 2 of each type full contact shim (total 72 shims). They are conveniently packaged for fast selection. The complete master assortment package contains all six full contact shim series and includes Part Number 15291, 15292, 15293, 15294, 15295, and 15296.

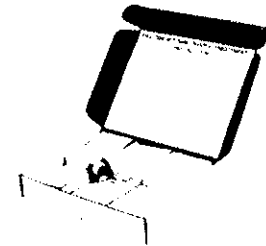

GENERAL MERCHANDISE

CASTER CAMBER SHIM ASSORTMENT (Part Number 340)

This assortment offers coverage depth in the most popular caster/camber shims with the added benefit of a permanent metal storage cabinet with see-through drawers.

Contents:

Part Number	Quantity
BU030	5
BU060	5
BU125	5
CC018	30
CC116	20
CC132	5
CT018	30
CT116	30
CT132	5
N018	50
N116	50
N132	20
US018	40
US116	5
US132	5

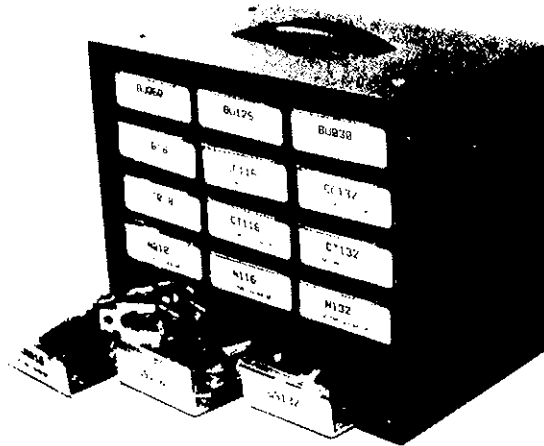

16901 Indexing tool is snapped on the axle arm when installing 16090-16093 Caster/Camber bushings in 1987 F150-F350 Ford pickups. Correct index setting for the bushing is determined from application chart on the installation instructions.

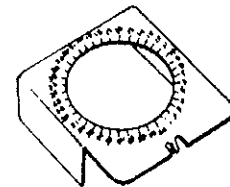

16904 Indexing collar for installation of 16060-16065 Caster/Camber Offset 4WD Bushings.



16916 7/8" Hole Saw for installation of 15412 Taurus/Sable front camber adjustment kit.

16917 Abrasion resistant insert guide. Use with 16916 hole saw.



16918 Taurus/Sable Bushing adjuster. Slim line wrench for adjusting 15401 Taurus/Sable rear wheel Camber/Toe Offset Bushings. Angled handle allows full 360° bushing rotation.



16919 Chrome Lug Nut Cover Remover. Abrasion resistant plastic coating will not scratch chrome.
Ref. No. RT070

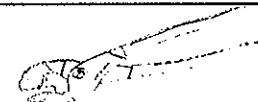

16920 3/4" hole saw with smooth 3/8" hardened pilot. Use to install 15402 Tempo/Topaz toe kit.

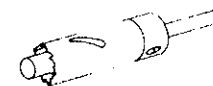

GENERAL MERCHANDISE

REAR WHEEL FULL CONTACT SHIM ASSORTMENTS

(Part Numbers 15291, 15292, 15293, 15294, 15295, and 15296)

These assortments contain 2 of each adjustable full contact shim for the vehicle application shown below. They include the complete range of full contact shims required to service the vehicle. Each assortment consists of 12 shims conveniently packaged for fast selection.

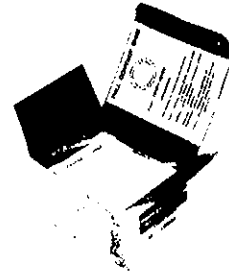

An assortment is offered for each type full contact shim series:

Part Number	Contents	Application
15291	2 ea. 15101 - 15106	Chrysler, Volkswagen/Audi
15292	2 ea. 15111 - 15116	GM X & J Body
15293	2 ea. 15121 - 15126	GM A & C Body
15294	2 ea. 15141 - 15146	Honda Civic & Prelude
15295	2 ea. 15131 - 15136	Chrysler Mini Vans,
15296	2 ea. 15151 - 15156	Nova, Tercel, Camry

CASTER CAMBER SHIM ASSORTMENT (Part Number 322)

Similar to assortment 110 shown above, but with broader coverage for light trucks.

Contents:

Part Number	Quantity
BU030	10
BU060	10
BU080	5
BU100	5
BU125	10
CC018	20
CC116	20
CC132	10
CO018	5
CO116	10
CO132	10
CT018	20
CT116	20
CT132	15
N018	20
N116	20
N132	20
US018	20
US116	20
US132	10
X018	5
X116	5
X132	5
X164	5



GENERAL MERCHANDISE

CAM BOLT ASSORTMENT (Part Number 15090)

This assortment of popular eccentric cam bolts offers a good starting inventory necessary to perform alignment jobs on many late model vehicles. Installation instructions are included.

Contents:

Part No.	Quantity	Application
15000	2	GM all A & X body-& J thru 84
15001	1	GM E body & Seville
15002	2	Chrysler W/FWD 1978-84
15003	1	Chrysler W/FWD 1984-87
15004	1	GM 87-88 2 & 4WD pickup
15005	1	Chrysler & Ford RWD vehicles
15006	1	GM C, H, N Body & J from 85



CASTER CAMBER SHIM ASSORTMENT (Part Number 110)

A basic assortment of the most popular caster/camber shims. This assortment offers basic coverage in the most popular shim sizes. The assortment is packaged in a convenient reusable plastic container.

Contents:

Part Number	Quantity
BU060	5
CC018	5
CC116	5
CT018	10
CT116	10
CT132	5
N018	15
N116	15
N132	10
US018	10
US116	10
US132	5

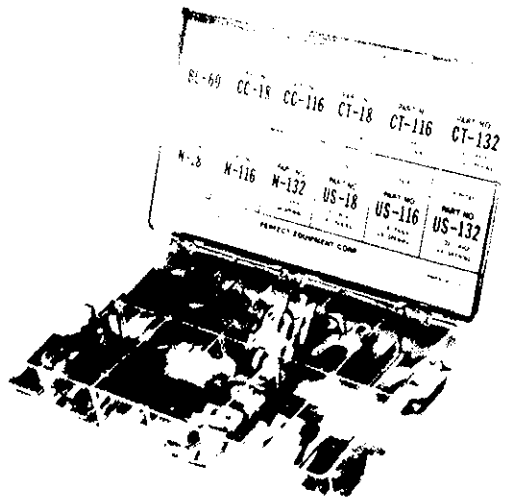

**FOR ADDITIONAL ALIGNMENT PRODUCTS INFORMATION,
REFER TO 'PERFECT EQUIPMENT' ALIGNMENT CATALOG
FOR PART NUMBERS AND APPLICATIONS.**

GENERAL MERCHANDISE

SHIMS

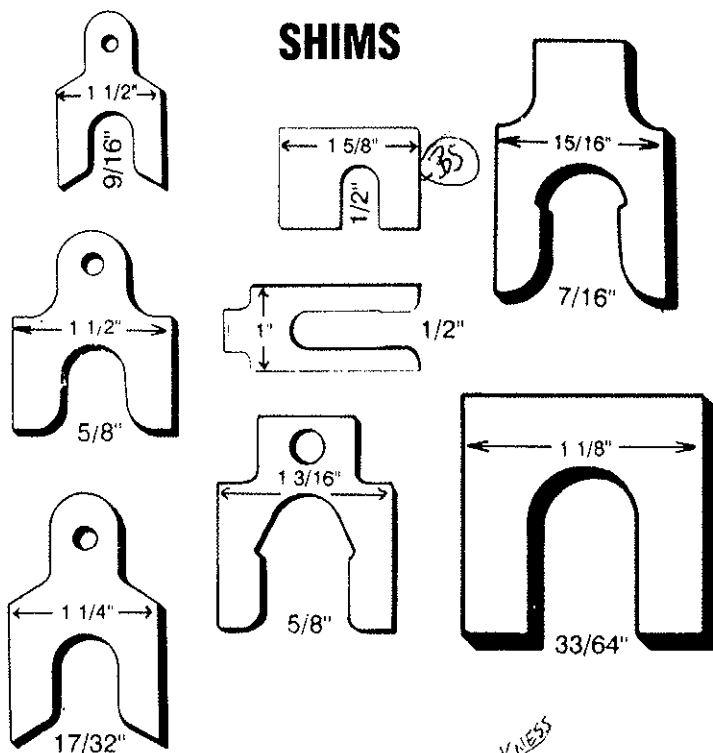

PART NO.	SIZE - Thickness	QUANTITY
TBS018	1/8"	25
TBS116	1/16"	25
TBU030	1/32"	50
TBU060	1/16"	50
TBU125	1/8"	50
TCC018	1/8"	50
TCC116	1/16"	50
TCC132	1/32"	50
TCO116	1/16"	50
TCO018	1/8"	50
TCT018	1/8"	50
TCT116	1/16"	50
TCT132	1/32"	50
TCT164	1/64"	50
TCT316	3/16"	50
TFS116	1/16"	25
TFS018	1/8"	25
TN018	1/8"	50
TN116	1/16"	50
TN132	1/32"	50
TN164	1/64"	50
TUS018	1/8"	50
TUS116	1/16"	50
TUS132	1/32"	50
TUS164	1/64"	50
TX116	1/16"	50
TX132	1/32"	50
TX018	1/8"	50



UNIVERSAL Jack

Rubber grommet on hook prevents bumper scratches. Ribbed, seam welded rack bar is zinc plated to prevent rust. Removable handle included.

T200



JOHNSON'S Quick Flat Fix

The best tire inflator and sealer on the market. May be used on tube or tubeless tires, for all passenger cars, motorcycle, bicycle and utility tires. 12 oz.

T3812TI

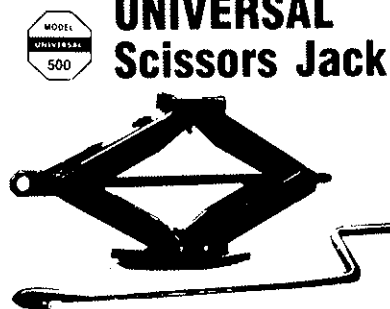

UNIVERSAL Scissors Jack

Formed U-shaped legs replace the old style strap construction. It can't twist or bend, even at full extension. Rolled screw spindle with extra fine threads works easier, lasts longer. Designed for 2000 pound class cars.

T500SJ

GENERAL MERCHANDISE

MILTON Valve Repair Tool

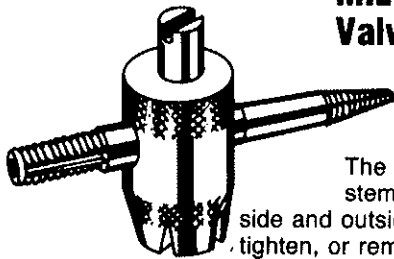

The 4-in one tool for valve stem and core. Rethreads inside and outside of Valve Stem...Insert, tighten, or remove Valve Core..."Easy-Out" to remove core if shoulders are broken off.. All steel, plated to resist corrosion.

T445

MILTON Tube Deflator and Core Remover



The 2-in-one tool. Deflator on one end - threaded I.D. enables attachment to valve stem...Valve Core wrench on the other end - to insert and tighten or remove core.

T446

MILTON Valve Tool

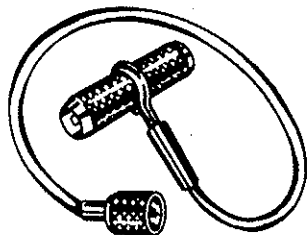

Valve fishing tool provides features of valve insertion tool, tube deflator and core remover. Strong steel cable.

T447

MILTON Valve Tool

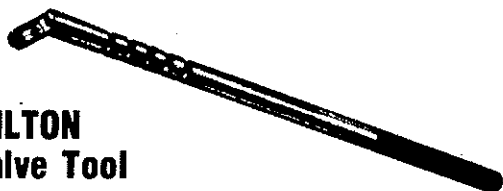

Valve insertion tool for the installation and removal of "snap-in" type tubeless tire valves.

T449

MILTON Air Hose Washers



Head chuck washers (standard size). Dual and straight.

**T5006M
T5007M**

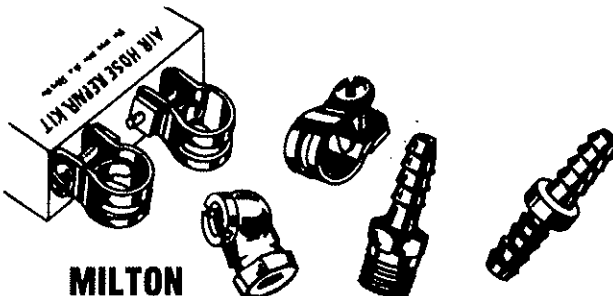

MILTON Air Hose Repair Kit

For 1/4" I.D. air hose.

Consists of:

- 1 Female Air Chuck (1/4" N.P.T.)
- 1 Male Hose End (1/4" N.P.T. x 1/4" I.D. Hose)
- 1 Hose Mender (1/4" I.D. Hose Both Ends)
- 3 Hose Clamps (5/8" O.D. Hose)

*NOTE: Sealing type chuck...Not to be used with Milton Inflator Gages.

T620

FULL SWIVEL HOSE ENDS

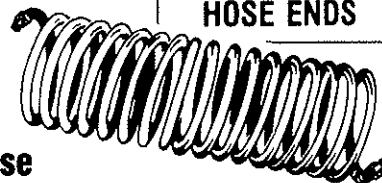

MILTON Re-Koil Air Hose

Ready to use...Completely assembled with spring guards and reusable fittings. 200 P.S.I. maximum working pressure. Resists oil, grease, corrosion and abrasion. Use with all air-operated equipment. Swivel fittings on both ends.

T669 25' 1/4" I.D. Hose with 1/4" Male N.P.T. both ends.

T670 50' 1/4" I.D. Hose with 1/4" Male N.P.T. both ends.

T674 25' 3/8" I.D. Hose with 3/8" Male N.P.T. both ends.

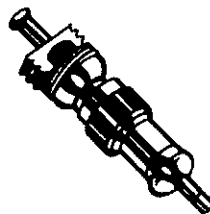

MILTON Tire Valve Core

Valve core has positive seal for fast inflation. Guaranteed airtight.

T404-100 100/bx.

GENERAL MERCHANDISE

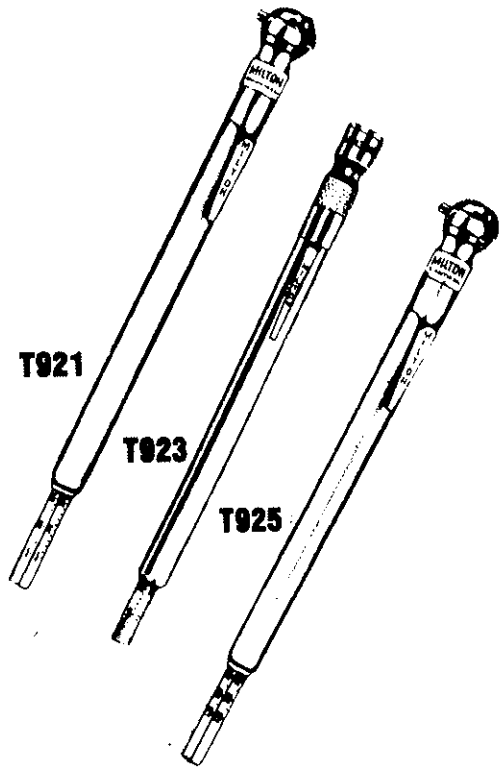

MILTON® Pencil Type Gages

- T921** Radial and Conventional Passenger Tire Gage, 2 sides 5 to 50 p.s.i. in 1 lb. increments and 2 sides kilo Pascals (kPa) 40 to 350 in 10 kPa increments.
- T923** Radial and Conventional Straight Chuck Passenger Car Tire Gage, ideal for gaging tires with decorative wheel covers. Two sides 5 to 50 p.s.i. in 1 lb. increments and 2 sides kilo Pascals (kPa) 40 to 350 in 10 kPa increments.
- T925** Tire Gage for Bicycles, RV's & Trucks. Two sides 20 to 120 p.s.i. in 2lb. increments and 2 sides kilo Pascals (kPa) 120 to 820 in 20 kPa increments.

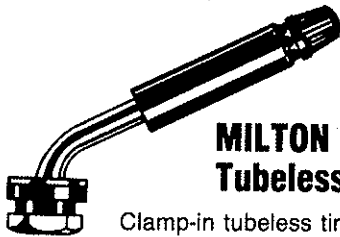

MILTON Tubeless Tire Valve

Clamp-in tubeless tire valve. Recommended where tire pressures exceed 40 p.s.i. Special...for Cadillac Eldorado and Oldsmobile Toronado.

T471 5/bx.

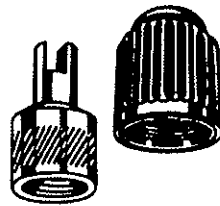

MILTON Valve Caps

- T437** Screw driver type, brass; nickel plated. 100/bx.
- T439** Dome type, plastic. 100/bx.

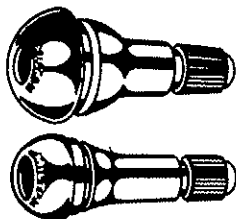

MILTON Tubeless Tire Valves

"Snap-in" type construction for easy installation. Finest quality, greater safety with ozone resistant rubber.



MILTON Valve Extension

Brass valve extension with "valve pin" type design for complete servicing.

T442 1¼" Effec. Length

MILTON Valve Extension

Plastic valve extensions are lightweight... do not affect wheel balance.

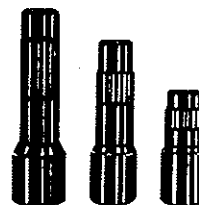

- T451** ¾" 50/bx.
- T452** 1¼" 50/bx.
- T453** 1½" 50/bx.
- T454** 2" 50/bx.

PART #	RIM HOLE DIA.	LENGTH	PER BOX
T413-50	.453	1¼"	50
T414-50	.453	1½"	50
T415-50	5/8"	1¼"	50
T418-50	.453	2"	50
T423-50	.453	2½"	50
T425-50	5/8"	2"	50

GENERAL MERCHANDISE



Made to meet
OSHA
Specifications

MILTON

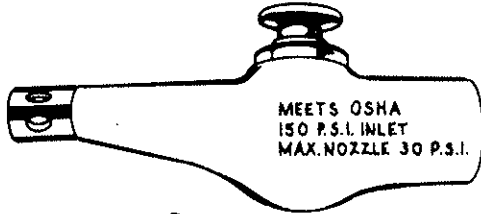

MILTON® Safety Button Blo-Gun

Streamlined shape comfortably fits the hand. Indispensable for cleaning fuel and oil lines, air cleaners and car interiors - drying out dust, dirt, filings, metal chips and hundreds of other uses.

T107 ¼" N.P.T.

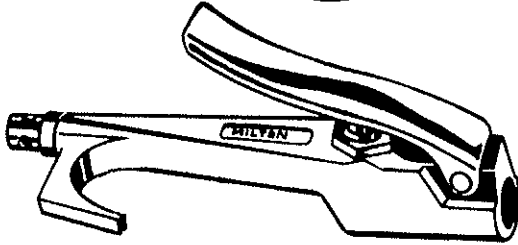

MILTON® Safety Lever Blo-Gun with Hang-Up Hook

Heavy duty construction for extra service. Extra large side hook design for easier hang-up without scraping knuckles.

TS120 ¼" N.P.T.

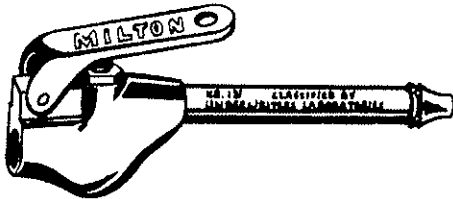

MILTON® Safety Blo-Gun

Four inch heavy brass extension, with approved by-pass safety nozzle. Four safety by-pass holes permit air to escape if hole in tip is obstructed. By-pass holes do not interfere with normal air flow.

T131 ¼" N.P.T.

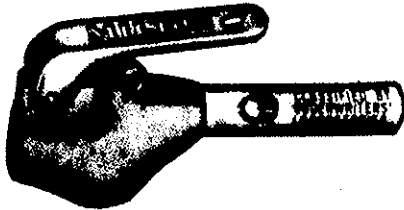

MILTON® Volumn Safety Blo-Gun

Special Venturi holes in the extension tube increase the air volume approx. five times that of conventional blo-guns, and yet maintains required noise level and required nozzle pressure with inlet pressure of 150 p.s.i. Also, for safety, allows air to escape if end of extension is blocked.

T132 ¼" N.P.T.

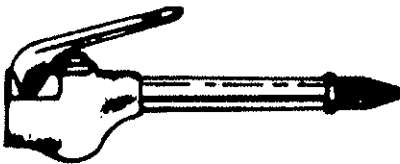

MILTON® Rubber Tip Blo-Gun

Heavy duty. For positive leak-proof connection when blowing out any fluid lines, automatic transmissions, etc. A must where metal tip could mar delicate finish in molds or fresh paint.

TS153 ¼" N.P.T.

MILTON Hose Whip Assembly

Hose whip assembly complete (straight head chuck, 12" hose, ¼" N.P.T.).

TS528



GENERAL MERCHANDISE

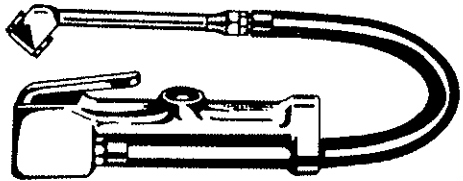

MILTON Inflator Gage

Dual head chuck (full swivel) inflator gage. Rugged construction. Heavy-duty to withstand everyday use and abuse and provide long service life.

T506



MILTON Chuck Clip

Chuck clip with single head chuck assembly. (Free flowing for tire gages only.)

T500-43

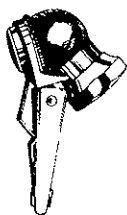

MILTON Safety Grip Air Chuck

Chuck clip with female air chuck. (Sealing type chuck...Not for use on Milton inflator gages.)

T698 1/4" N.P.T.

MILTON Female Air Chuck



Precision construction. 1/4" N.P.T. Sealing type chuck...Not to be used with Milton inflator gages.

T699



MILTON Tank Conversion Kit

MAKE YOUR EMPTY FREON TANKS INTO USABLE OR SALABLE AIR TANKS.

No special tools required. Complete parts kit contains: Filter Valve, Air Gage, Safety Valve Assembly, Air Hose Assembly, Chuck and 4-way Manifold.

TS682

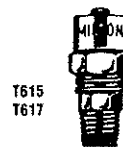
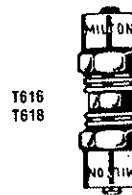

MILTON Re-Usable Brass Fittings

Easy assembly...sure grip connections.

T615 Hose End, Male 1/4" N.P.T.
(Fits 1/4" I.D. Hose with 19/32" or 9/16" O.D.)

T616 Hose Mender
(Fits 1/4" I.D. Hose with 19/32" or 9/16" O.D.)

T617 Hose End, Male 1/4" N.P.T.
(Fits 1/4" I.D. Hose x 5/8" O.D. Hose)

T618 Hose Mender
(Fits 1/4" I.D. Hose x 5/8" O.D. Hose)

NOTE: The above fittings can, in many cases, be used satisfactorily with 5/16" I.D. Hose.

MILTON BRASS HOSE FITTINGS



T602
Male Hose End

3/8" I.D. Hose x 1/4" N.P.T.



T622
Male Hose End

3/8" N.P.T.
(Fits 3/8" I.D. Hose x 3/4" O.D. Hose)



MILTON Male Hose End

Zamak alloy, 1/4" I.D. Hose x 1/4" N.P.T.

T663



MILTON Hose Mender

Zamak alloy, 1/4" I.D. Hose both ends.

T676



MILTON Handee BEND Water Nozzles

"Jumbo" Handee-Bend full-flo water nozzle. Approx. 8 1/4" long. Female garden hose thread.

T375

GENERAL MERCHANDISE

MILTON "KWIK-CHANGE"® COUPLERS

Used with All Air Operated Equipment Such As: Blow Guns, Tire Inflators, Paint Sprayers, Air Hammers, Air Drills, Greasing Equipment, Oil Sprays, Retreading and Vulcanizing Equipment.



Coupler Body, Female

T715 1/4" N.P.T.

T718 3/8" N.P.T.



Coupler Plug, Male

T726 1/8" N.P.T.

T727 1/4" N.P.T.

T733 3/8" N.P.T.



Coupler Body, Male

T716 1/4" N.P.T.

T719 3/8" N.P.T.



Coupler Plug, Female

T728 1/4" N.P.T.

T732 3/8" N.P.T.



Coupler Assembly

Consists of:
1/4" N.P.T. Female, Coupler Body
1/4" N.P.T. Male, Coupler Plug

T711

MILTON "KWIK-CHANGE"® "A" Couplers

Designed to Interchange with Aro Style Couplers. Push Type - Plug Engages Automatically. Steel Body - with Hardened Steel Plugs. Rugged, Durable.



Female "A" Coupler Body

(Interchange for Aro #210)

T775 1/4" N.P.T.



Male "A" Coupler Plug

(Interchange for Aro #A2608)

T777 1/4" N.P.T.



Female "A" Coupler Plug

(Interchange for Aro #A2609)

T778 1/4" N.P.T.

GENERAL MERCHANDISE

MILTON "KWIK-CHANGE"® "T" COUPLERS

Designed to Interchange with Tru-Flate, Parker Hannifin Style Couplers. Hardened Steel Plugs. Rust Resistant, Maximum Air Flow for 1/4" Couplers.



T783



T784

Coupler Plugs

- T783** 1/4" N.P.T., Male
T784 1/4" N.P.T., Female



T785



T786

Coupler Body

- T785** 1/4" N.P.T., Female
T786 1/4" N.P.T., Male



"KWIK-CHANGE"® LINCOLN STYLE COUPLERS

Push Type - Plug Engages Automatically. Steel Body - with Hardened Steel Plugs. Rugged, Durable.



- T790** 1/4" N.P.T. Female Body (Sub for Lincoln #815)



- T791** 1/4" N.P.T. Male Plug (Sub for Lincoln #11661)



- T792** 1/4" N.P.T. Female Plug (Sub for Lincoln #11659)

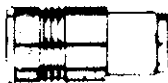

T1803

1/4" N.P.T. Female Coupler Body

BASIC SIZE AIR COUPLERS

Heavy Duty steel bodies and hardened steel plugs. Treated to resist rust.

For use where more air volume is needed



T1810

1/4" N.P.T. Female Coupler Plug



MILTON Male Coupler Plug

Tru-Flate style, hardened steel plug. treated to resist rust. For use where more air volume is needed.

- T1809** 1/4" N.P.T., Male

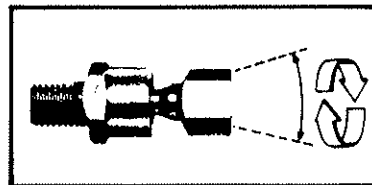

MILTON Full Swivel Hose Ends

Full 360° swivel hose ends help to eliminate kinked and twisted air line. Higher c.f.m. than other swivel hose ends. Steel construction, black oxide finish.

- T659** Male 1/4" N.P.T. x 1/4" N.P.T. Female Swivel Hose End

GENERAL MERCHANDISE

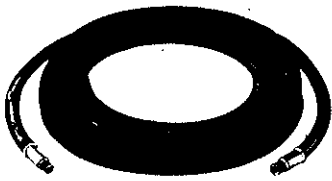

STIMSONITE AIR HOSE

For service stations, garages and industry. 2-ply heavy duty construction. Individually boxed. 1/4" N.P.T.

OLD #
 T42225 (T19378) 1/4" x 25'
 T42250 (T19380) 1/4" x 50'
 T43825 (T10376) 3/8" x 25'
 T43850 (T10394) 3/8" x 50'

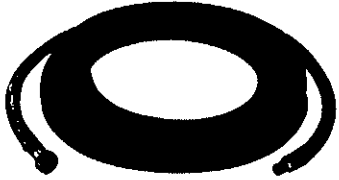

WATER HOSE

OLD #
 T165750 (T10242) 5/8" x 50' utility water hose
 T59050 (T22028) 5/8" x 50' HD wash rack hose
 T54350 5/8" x 50' HP wash hose



STIMSONITE PCV HOSE

OLD #
 T1132 (T05940) 1 1/32" x 25'
 T1532 (T05942) 15/32" x 25'



FUEL LINE HOSE

STIMSONITE	ANCO	DORMAN
T25062 1/4" x 25'	W71316 3/16" x 25'	T501090 3/16" x 25'
T25080 5/16" x 25'	W71516 5/16" x 25'	T503100 1/4" x 25'
T25090 3/8" x 25'	W71616 3/8" x 25'	T503110 5/16" x 25'
T25100 3/8" x 250'		T503120 3/8" x 25'
T25106 7/16" x 25'		



WINDSHIELD WIPER HOSE

Precision extruded to rigid ID/OD tolerances.

STIMSONITE	ANCO	DORMAN
OLD #		
T3339 (T10522) 7/64" x 50'	W74216 1/8" x 50'	T506-007 7/64" x 100'
T3340 (T10524) 5/32" x 50'	W74316 3/16" x 50'	T506-009 5/32" x 50'
T3341 (T10526) 7/32" x 50'	W74416 1/4" x 50'	T506-010 7/32" x 50'



FUEL INJECTION HOSE

Fluoroelastomer fuel line. Resists high pressure and sour gas oxidation created by high heat under the hood as the fuel returns to the fuel tank. Burst pressure; 900 lbs. psi..

TFI503 5/16" I.D. x 10'
 TFI504 3/8" I.D. x 10'



HEATER HOSE (50 ft. sections)

STIMSONITE
 OLD #
 T1835 (T30712) 1/2" RED
 T1825 (T30702) 1/2" BLACK
 T1836 (T30714) 5/8" RED
 T1826 (T30704) 5/8" BLACK
 T1837 (T30716) 3/4" RED
 T1827 (T30706) 3/4" BLACK

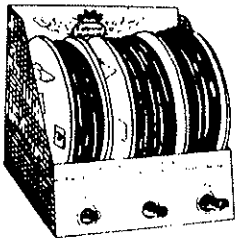

Hose Dispenser and Rack

FOR FUEL LINE HOSE
 Fuel line dispenser includes 25 foot spools of 1/4", 5/16", and 3/8" fuel line plus 20 matching hose clamps in their own boxes in the tray above each matching "spoolhose".
 T015006

FOR WINDSHIELD WIPER HOSE
 Windshield wiper hose dispenser includes: 100 ft. spool of 7/64", 50 ft. spools of 5/32" and 7/32" tube and box of each tee connectors T493007, T493009, and T493010.
 T015-090

GENERAL MERCHANDISE

BRASS HOSE FERRULES

Economical and dependable brass ferrules enable you to make up custom hose assemblies. Because rubber hose tolerances vary up to $\pm 1/32$ " on the I.D. and O.D., it is necessary to fit ferrules and fittings to each individual hose being made up.



T8646	1" x .856" I.D. BRASS FERRULE
T8647	1" x .887" I.D. BRASS FERRULE
T8648	1" x .718" I.D. BRASS FERRULE
T8649	1" x .750" I.D. BRASS FERRULE
T85412	7/8" x .900" I.D. BRASS FERRULE

PACKED 10 PER BOX

NOTE: Because rubber hose tolerances vary up to $\pm 1/32$ " on the I.D. and O.D., it is necessary to fit ferrules and fittings to each individual hose being made up.

MILITARY BRASS FERRULES				
854-6	854-7	854-8	854-9	854-12
2 1/32"	1 1/16"	2 3/32"	3/4"	7/8"
0 0	0 0	0 0	0 0	0 0

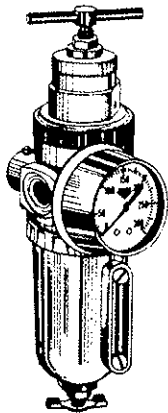

AIR REGULATOR

This space-saving filter/regulator is designed for general application in compressed air service where effective filtration and reliable, accurate pressure regulation with large flow capacity is required. The gauge ports are full flow and can be used as auxiliary outlet ports. All three units have 1/2 pint diecast aluminum bowls, with sight glass on the filter section. The filter/regulator unit can be disassembled without removal from the air line.

T7Z553

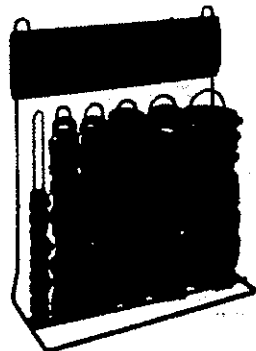

Hose Clamp Rack

THCR

MINI

Hose Clamps

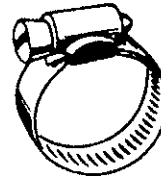

Recommended for light duty use. Three piece construction has stainless steel band, housing and plated 1/4" hex head.

PART NO. SIZE(ID) OPENS TO

TM4P	1/8 to 1/4	5/8"
TM6P	1/4 to 3/8	25/32"
TM8P	5/16 to 1/2	29/32"

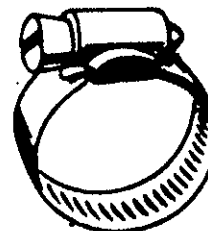

REGULAR Hose Clamps

PART NO. SIZE(ID) OPENS TO

T8H	5/16 to 1/2	29/32"
T10H	3/8 to 5/8	1 1/16"
T16H	3/4 to 1	1 1/2"
T20H	1 to 1 1/4	1 3/4"
T24H	1 1/4 to 1 1/2	2"
T28H	1 1/4 to 1 3/4	2 1/4"
T32H	1 1/2 to 2	2 1/2"
T36H	1 3/4 to 2 1/4	2 3/4"
T40H	2 to 2 1/2	3"
T48H	2 1/2 to 3	3 1/2"
T52H	3 to 3 1/4	3 3/4"
T56H	3 1/4 to 3 1/2	4"
T64H	3 3/4 to 4	4 1/2"

GENERAL MERCHANDISE

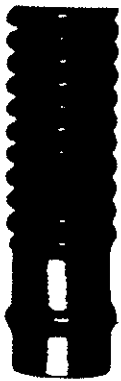

COOPER Exhaust Hose

For all model cars and trucks from 1954 and later. New exclusive vacuum-forming process gives you an exhaust hose that is better in many ways. Order per foot in 10 ft. increments.

T91202	2"	T91402	4"
T91252	2½"	T91502	5"
T91302	3"		

Exhaust Hose Pipe Adaptor



Oval exhaust pipe adaptor for oval and twin pipes. 2½" and 3" hose fits inside adaptor—4" hose fits outside.

TF475



COOPER Y Adapter

HD "Y" adapter can be used with 2" or 2½" hose from two exhausts and 2½" or 3" hose exhaust system outlet.

TRY25

COOPER Universal Adapter



Special compounded rubber adapter will fit all domestic automobiles from 1954 and later. Easily adjust with special fasteners to fit tailpipes. Fits over 2½" hose or inside 3" hose.

T91264

COOPER Door Port

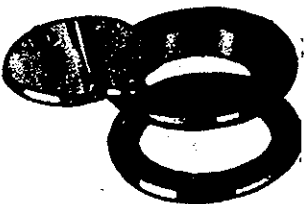

Rugged aluminum door port is easy to install and has gravity door that automatically shuts when unit is not in use.

T91261

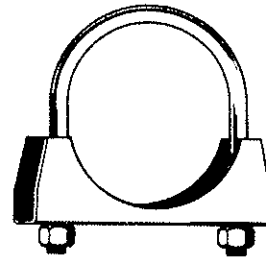

Regular Muffler Clamps

PART NO.	SIZE	PART NO.	SIZE
TMC114	1 1/4"	TMC2	2"
TMC112	1 1/2"	TMC218	2 1/8"
TMC158	1 5/8"	TMC214	2 1/4"
TMC134	1 3/4"	TMC212	2 1/2"
TMC178	1 7/8"		

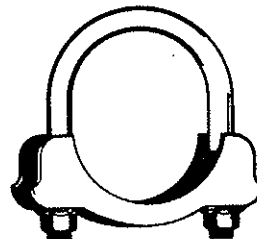

HEAVY DUTY CLAMPS

PART NO.	SIZE	PART NO.	SIZE
TMC134HD	1 3/4"	TMC214HD	2 1/4"
TMC178HD	1 7/8"	TMC212HD	2 1/2"
TMC2HD	2"	TMC234HD	2 3/4"
TMC218HD	2 1/8"	TMC3HD	3"
		TMC4HD	4"
		TMC412HD	4 1/2"
		TMC5HD	5"

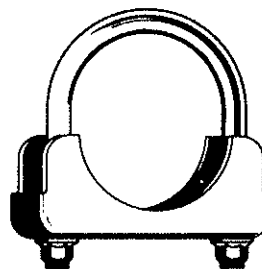

HEAVY DUTY GM CLAMPS

PART NO.	SIZE
TMC134HDGM	3/4"
TMC112HDGM	1 1/2"
TMC178HDGM	1 7/8"
TMC212HDGM	2 1/2"
TMC214HDGM	2 1/4"
TMC218HDGM	2 1/8"
TMC2HDGM	2"

GENERAL MERCHANDISE

Universal Hanger

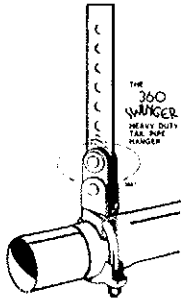

The 360 Swinger meets any installation problems you can come up against. Fits any and all configurations. The unique hanger swings left and right from zero to 45, right and left deep knee bends, and will turn 360° at the same time.

TTPH360

"HANG-IT-ALL" UNIVERSAL RUBBER LOOP HANGER

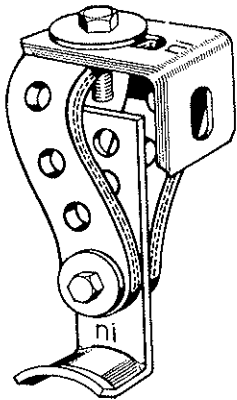

Does the job of dozens of different parts. It's the ONE rubber loop hanger that adapts easily to fit most Ford and GM installations; many foreign cars, too. It's fast easy and eliminates rattles and vibrations.

TTPH46

Laminated Split Flange For Catalytic Converters*

Dissipates heat buildup and prevents premature catalytic converter flange burnout. It's made 5-layers tough for strength and durability. It comes in two sizes (2-2¼") to fit all converters with 2" to 2½" outlet pipes. Packaged complete with 3/8" tap bolts and heat treated locking flange nuts. Goes on easy and extends converter life.

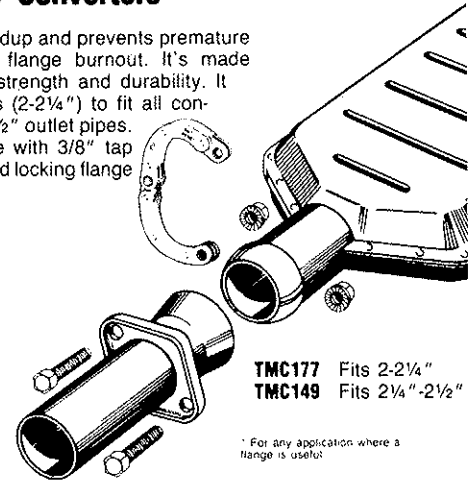

TMC177 Fits 2-2¼"
TMC149 Fits 2¼"-2½"

* For any application where a flange is useful

SAFE-T-EDGE Perforated Hanger Bar

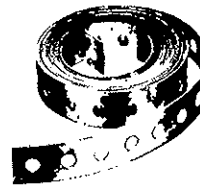

Perforated hanger bar has holes for ¼" bolts. 17/64"

THB1

Muffler Cement



Requires no mixing or preparation. Dries hard as metal to seal joint and seam leaks and muffler burst holes.

T60Z Handy 6 oz. size

T160Z 1 lb. shop size

Hanger Kits For Omni/Horizon and K Cars

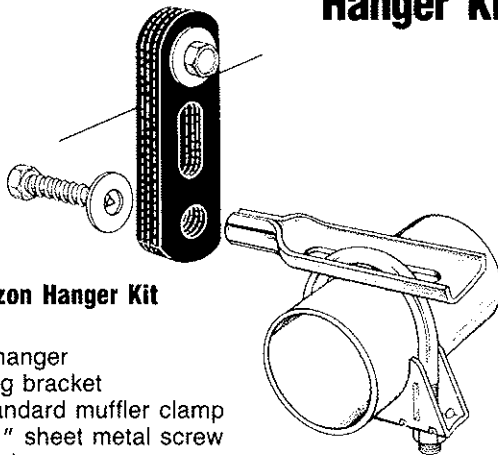

TTPH190 Omni/Horizon Hanger Kit

Includes:
rubber hanger
mounting bracket
1½" standard muffler clamp
3/8" x 1" sheet metal screw
3/8" washer

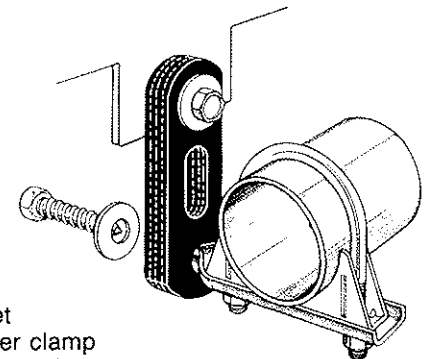

TTPH191 K Car Hanger Kit*

Includes:
rubber hanger
mounting bracket
1-7/8" std. muffler clamp
3/8" x 1" sheet metal screw
3/8" washer

*Fits many other Chrysler models.

GENERAL MERCHANDISE



CHIEFTAIN Grease Fittings

Pkg.-100
1/8" pipe thread straight

T610
T610PK 10/pack

CHIEFTAIN Grease Fittings

1/4-28 short pkg.-100

T641
T641PK 10/pack



CHIEFTAIN Grease Fittings

Pkg.-100
1/8" pipe thread
(90° angle)

T613
T613PK 10/pack



CHIEFTAIN Grease Fittings

1/4-28 (45°) pkg.-100

T637
T637PK 10/pack



CHIEFTAIN Metric Fittings

6mm/1 Pkg.-100

T9001
T9001PK 10/pack



CHIEFTAIN Grease Fittings

1/4-28 (90°) pkg.-100

T911
T911PK 10/pack

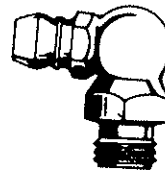

CHIEFTAIN Metric Fittings

6mm/1 x 45° Pkg.-100

T9041
T9041PK 10/pack

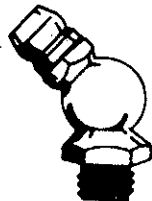

CHIEFTAIN Metric Fittings

6mm/1 x 90° Pkg.-100

T9061
T9061PK 10/pack

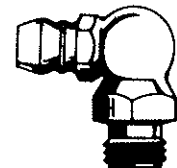

GENERAL MERCHANDISE

KP INDUSTRIES Drain Pan

Deluxe drain pan features a huge 7 gal. capacity with carrying handles and a hooded baffle. (Old# T3174)

T52175

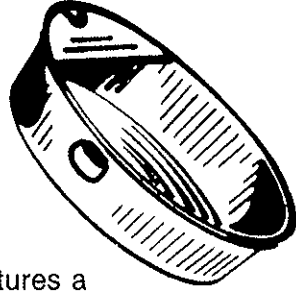

KP INDUSTRIES Drip and Drain Pans

Model T52172 features ribbed galvanized steel construction. Model T52173 features built-in pour spout.

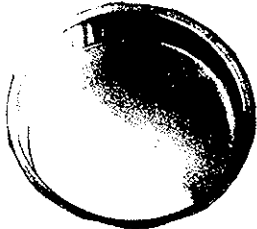

T52172

T52172 (Old# T2172H) 13 qt., 17½" dia., ribbed galvanized.



T52173

T52173 (Old# T2173) 6.5 qt., 12" dia., hi-strength plastic



Model TLN3604

Decorative Waste Oil Drain

Designed for easy maintenance. One wipe and the sleeve is shiny clean! Float gauge on top tells you when the inside drum is full. Adjustable assembly. Rolling base.

Part No. TLN3604

BROOKINS Plastic Drain

Round black plastic drain with pour spout under baffle for easy emptying, and bail type handle for sliding and pouring.

T52174 5 gal. 18" dia., 5¾ deep



KP INDUSTRIES Transmission Pan Adapter

T51576

(Old# T1576)

Transmission Pan Adapter

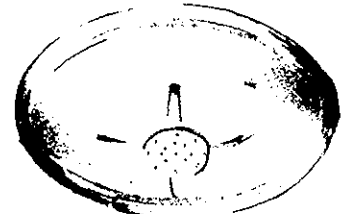

KP INDUSTRIES Lift Drain

Lift drain features all steel construction, wide mouth tapered funnel, thumb screw height adjustment.

T51579 (Old# T1579)

KP INDUSTRIES Casters

Casters made for T51579 lift drain.

T51577 (Old# T1577)

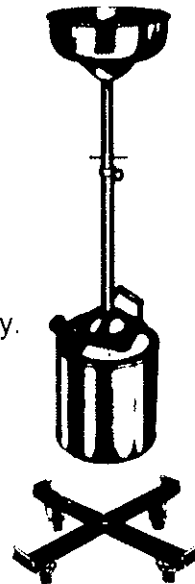

GENERAL MERCHANDISE



KP INDUSTRIES Swingspout Thumb Control Oil Measures

A thumb control mechanism opens and closes the oil flow in the bottom of the measure. Popular in professional garages, fleets, and industrial applications where oil or other liquids are dispensed in bulk. (Old# T1335)

T51335 5 qt. Flexspout with Automatic Trans Top & Strainer.



KP INDUSTRIES Filter Wrench

Has an extra wide 1 1/4" strap to limit crushing of oil filter. Made of high quality domestic steel. (Old# T5532C)

T75532

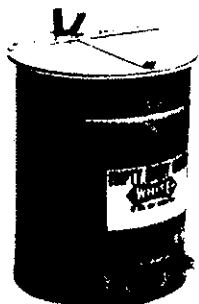

Oily Rag Can

Prevent fires caused by oily rags with this 15 gallon container.

N7900



KP INDUSTRIES Multi-Purpose Funnel

1 pint and 4 quart galvanized multi-purpose funnels.

T64410 (T4410) 1 pint

T64414 (T4414) quart

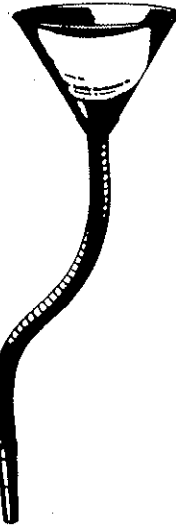

KP INDUSTRIES Flex-Funnel

1 qt. galvanized, with 16" flex-metal spout, reducer tip and filter screen. (Old# T1461)

T61461



KP INDUSTRIES Transmission Funnel

Transmission funnel, hardened blade opener, flex-spout with automatic transmission tip. (Old# T1074)

T61074

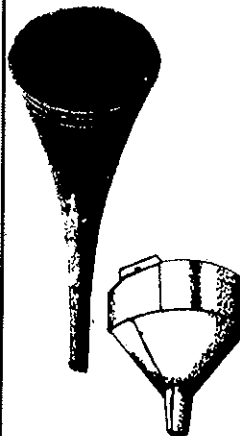

KP INDUSTRIES Plastic Utility Funnel

1 qt. long neck, super funnel deluxe; rapid flow. Red

T64468 (Old# T4468)

2 quart. 6 1/2" diameter, filter screen. Red.

T64458 (Old# T4458)

GENERAL MERCHANDISE

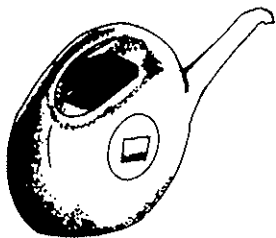

KP INDUSTRIES Radiator Fillers

Plastic radiator fillers won't scratch auto surface, will not dent or leak. Galvanized filler is hot-dipped for long life.



T52104 (Old# T2104) Plastic
T53102 (Old# T3102) Galv.

KP INDUSTRIES Battery Filler & Tip

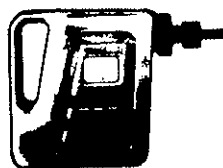

Plastic battery filler will not scratch or mark auto surface.

T52108 (Old# T52108) Filler
T52109 (Old# T52109) Tip

KP INDUSTRIES Gas Cans

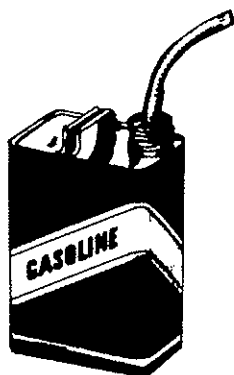

Rugged steel cans are rust resistant with double-seamed tips and bottoms. Reversible flex metal spout and flip-up polyvent. Safety styled in red and yellow colors.

T14657 (Old# T4657) 5 gal round

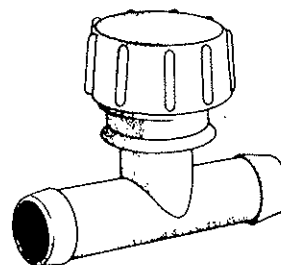

FLUSHING TEE

Cooling system flushing "T" used for easier cleaning of radiator and engine. Connects in heater hose.

T12FT 1/2"
T58FT 5/8"
T34FT 3/4"

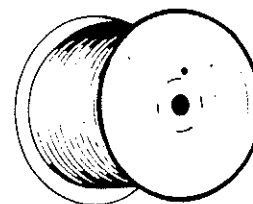

MECHANICS WIRE

5 lb. roll, black annealed wire. All-purpose.

T5MW 18 gauge

SPAN MASTER TARP STRAPS



- Specially compounded rubber for long life
- Eliminates tearing and flapping
- Keeps haul safe from weather
- Keeps tarp secure
- Fast and neat

Part Number	Strap Length	Overall Length	Recommended Span Using 2 S Hooks
J81101	9"	14"	15" - 20"
J81102	15"	20"	20" - 30"
J81103	20"	25"	30" - 40"
J81104	32"	37"	40" - 55"

All straps include (2) 2 1/2" S hooks



Black Fender Cover

Tough, durable, neoprene top surface. Resists grease, oil and battery acids. Underside is specially compounded rubber that clings to surfaces without affecting finishes. Edges bound with sturdy leatherette fabric. 27" x 40".

TMFP-9

GENERAL MERCHANDISE

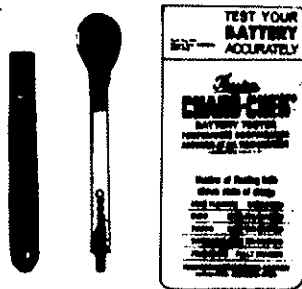

THEXTON Battery Check

Bead-type, fits into pocket. Tests accurately from -40° to 130°.

T115

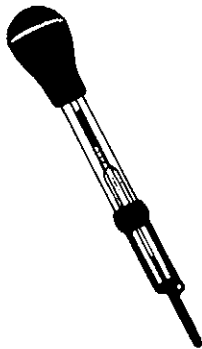

THEXTON Coolant Tester

Chrome-plated safety shield to prevent breakage. Comes with vinyl pocket protector case imprinted with instructions.

T106T



THEXTON Cold Check

Anti-freeze and coolant tester. Shows protection in celsius and fahrenheit. Scale printed on tester.

T102

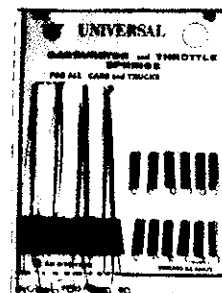

UNIVERSAL Carburetor and Throttle Springs

For all cars and trucks. Contains twelve throttle springs and twelve carburetor springs.

TS602C

GENERAL MERCHANDISE



MILFORD 'BI-METAL' HACKSAW BLADES

Featuring easy starting teeth up front. They cut longer, cleaner, are flexible, and fully hardened so teeth stay sharp longer.

SIZE	TEETH	PART No.
12" x 1/2"	18	N20545
	24	N20546

10 BLADES PER PACKAGE



Propane Tank

Disposable propane fuel cylinder meets DOT standards. 1" threaded bushing with pressure relief valve.

T9414

LAITNER Wire Brushes

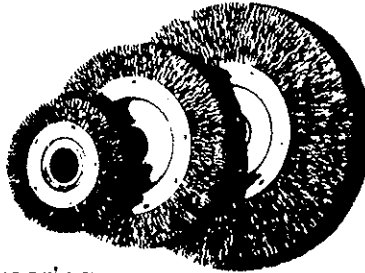

Fast cutting, long wearing wire wheels. Widely used in the automotive, do-it-yourself, farm and hardware markets.

T954 4" dia. med wire (.012) 1/2" to 5/8" arbor hole wire wheel brush (Old# T96A)

T955 6" dia. med wire (.012) with 1" arbor hole wire wheel brush (Old# T99)

LAITNER Wire Wheel Brushes

For the use with portable air and electric tools to remove carbon deposits, rust scale or paint from hard to reach areas.



1 1/4" dia. .014 ga. cup type.

T964 (Old# T107L)



1 1/8" dia. .020 ga. twisted wire, knot end wire brush.

T963 (Old# T110L)



1" dia. .023 solid end wire brush.

T962 (Old# T106)

GENERAL MERCHANDISE



COBALT HEAVY DUTY JOBBERS LENGTH DRILL Cobalt HSS, Surface Treated, 135° Split Point

Cobalt jobbers length drills are used for drilling in tough, high tensile strength materials like stainless steels, titanium and inconel. They are made of heat resistant, 8% cobalt high speed steel, with heavy duty flute construction and 135° split point. They are made to NAS 907 Type J specifications.

SIZE	PART #	SIZE	PART#
1/16	NI1904	23/64	NI1923
5/64	NI1905	3/8	NI1924
3/32	NI1906	25/64	NI1925
7/64	NI1907	13/32	NI1926
1/8	NI1908	27/64	NI1927
9/64	NI1909	7/16	NI1928
5/32	NI1910	29/64	NI1929
11/64	NI1911	15/32	NI1930
3/16	NI1912	31/64	NI1931
13/64	NI1913	1/2	NI1932
7/32	NI1914		
15/64	NI1915		
1/4	NI1916		
17/64	NI1917		
9/32	NI1918		
19/64	NI1919		
5/16	NI1920		
21/64	NI1921		
11/32	NI1922		

Individually packaged in a colorful vinyl pouch.

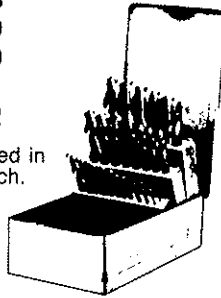

COBALT DRILL SET
N99822 • 29 Pc. Set
Cobalt Jobbers Drills from 1/16" to 1/2" diameters by 64ths in metal index.



HEAVY DUTY High Speed Steel Drills

135° SPLIT POINT

FRACTIONAL SIZES

STOCK NO.	DIAM. INCHES	LENGTH OVERALL INCHES
N11404	1/16	1 7/8
N11405	5/64	2
N11406	3/32	2 1/4
N11407	7/64	2 5/8
N11408	1/8	2 3/4
N11409	9/64	2 7/8
N11410	5/32	3 1/8
N11411	11/64	3 1/4
N11412	3/16	3 1/2
N11413	13/64	3 5/8
N11414	7/32	3 3/4
N11415	15/64	3 7/8
N11416	1/4	4
N11417	17/64	4 1/8
N11418	9/32	4 1/4
N11419	19/64	4 3/8
N11420	5/16	4 1/2
N11421	21/64	4 5/8
N11422	11/32	4 3/4
N11423	23/64	4 7/8
N11424	3/8	5
N11425	25/64	5 1/8
N11426	13/32	5 1/4
N11427	27/64	5 3/8
N11428	7/16	5 1/2
N11429	29/64	5 5/8
N11430	15/32	5 3/4
N11431	31/64	5 7/8
N11432	1/2	6



TRIUMPH Double Ended Drill

Double ended sheet metal drill designed especially for automotive body work.

T98809 9/64" 2" Length
T98808 1/8"



Unibit®

Perfect all-around bit for most common drilling jobs. Three-sided shank runs true, eliminating need to over-tighten drill chuck.

T-UNIBIT1 1/8" to 1/2" hole

T-UNIBIT10 1/2" hole

DRILL BIT ASSORTMENT

Heavy duty industrial 135° split point. Sizes 1/16" to 1/2", by 64ths. Complete with metal box.

N99803

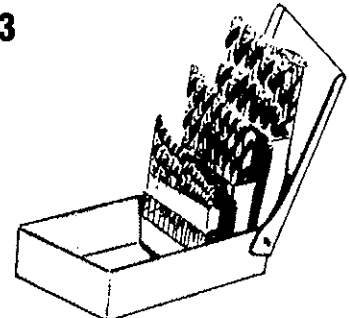

GENERAL MERCHANDISE



SUCTION GUN

Suction gun has 16 Ounce capacity, vinyl hose. Multi-purpose draining gun.

T45230 (Old# T2542)

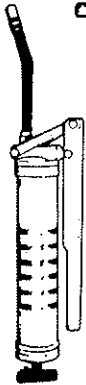

KP INDUSTRIES Grease Gun

Electro-coated, deluxe grease gun has 20 oz. capacity. Can be cartridge loaded, suction loaded or filler pump loaded.

T35525 (Old# T2541)



GREASE GUN HOSE

Twelve inch whip hose, used for hard to reach grease fittings. Adds the extra reach needed.

T32045 (Old# T2582C)

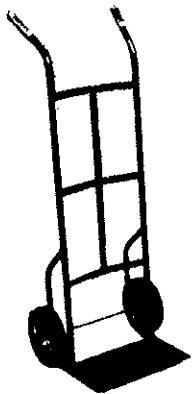

Hand Truck

This hand truck is constructed of a rugged tubular-steel frame. Concave metal cross strips and center strips increase load-handling ability. The No. 164 has a 9" x 15" load plate and is equipped with 8" semi-pneumatic rubber tires.

Load capacity 500 lbs.

N164

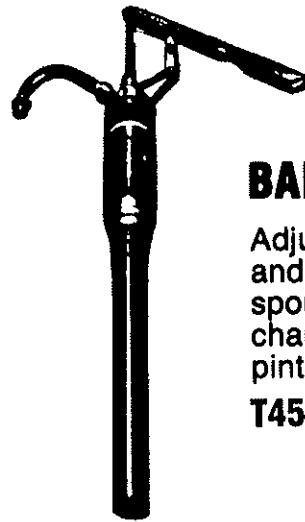

BARREL PUMP

Adjustable suction tube and threaded discharge spout. Designed to discharge approximately one pint per stroke.

T45485 (Old# T2545)

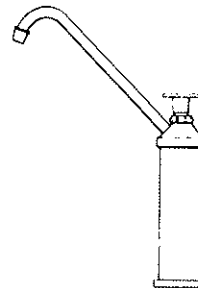

5 Gal. Drum Pump

Drum pump for 5 and 6 gal. pails with flex spout openings

T42805

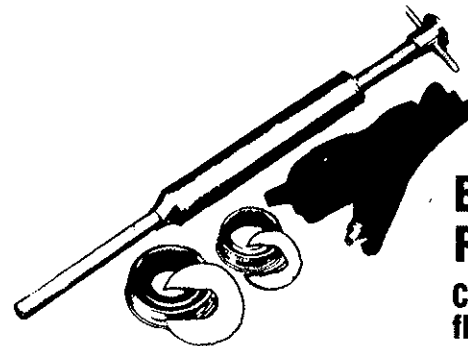

BRAKE FLUID PUMP

Complete with 36" flexible tubing.

T52544 (Old# T2544C)

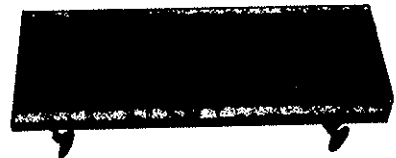

MECHANICS CREEPER

Sturdy creepers built of top-quality hardwoods, air-dried for long life. Headrest is of sponge rubber, with durable oil resistant covering.

THDS445

GENERAL MERCHANDISE



UNIVERSAL Jack

Rubber grommet on hook prevents bumper scratches. Ribbed, seam welded rack bar is zinc plated to prevent rust. Removable handle included.

T200

BLACKHAWK CAR/TRUCK STANDS

A must for everyone who works under cars and trucks

Wide range... 3 ton to 6 ton capacity. Most popular design... for professional shop use. 4 on-the-floor design provides greater resistance to tipping. Special load-lock handle is an extra feature, the load must be off the saddle before the stand can be lowered. Wide area saddle gives maximum load control. Rugged design with reinforced joints throughout.



T67703
3 Ton



T67706
6 Ton

Model No.	Capacity(tons)	Low Height	High Height	Base	Weight
T67703	3(2722 Kg)	11-3/4"	17-1/8"	7-1/2 x 8-3/4"	23 lbs. pr.
T67706	6(5443 Kg)	15-7/8"	24-1/2"	10" x 12"	43 lbs. pr.

UNIVERSAL Scissors Jack

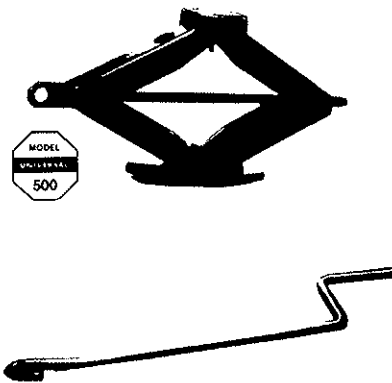

Formed U-shaped legs replace the old style strap construction. It can't twist or bend, even at full extension. Rolled screw spindle with extra fine threads works easier, lasts longer. Designed for 2000 pound class cars.

T500SJ



JOHNSEN'S Quick Flat Fix

The best tire inflator and sealer on the market. May be used on tube or tubeless tires, for all passenger cars, motorcycle, bicycle and utility tires. 12 oz.

T3812TI

HAND OPERATED WRINGER

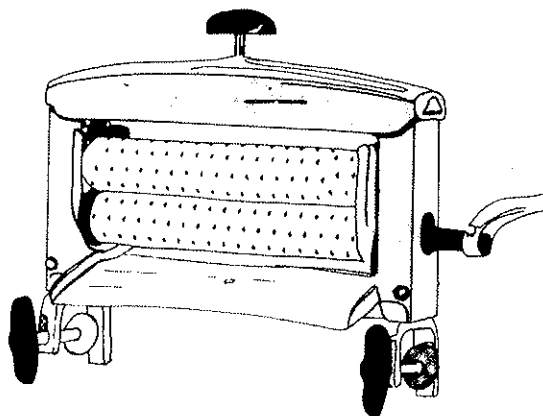

• REMOVES TWICE AS MUCH WATER AS A SPIN DRY

- Removes 90% of the water — spin dry or automatic washers only remove 45%
- Adjustable spin — Great for thin items as well as bulky items such as towels.
- Used at garages, car washes, hospitals, swimming pools, hotels, even at home.
- Longer life to chamois, towels, bathing suits, etc.

UPROCW1

GENERAL MERCHANDISE

ORBITAL CAR WAXER

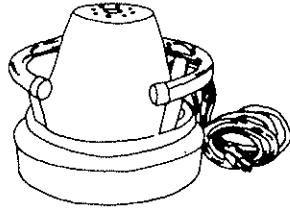

Waxer utilizes orbital action that duplicates the motion of your hand to give a brilliant finish with no burns, streaks or swirls. 1½" thick, 15" diameter foam pad provides ample, flexible, cushioned mounting surface for the terrycloth bonnets.

TORBUFF.....Orbital Buffer
 TORBON.....15" Terrycloth Bonnets
 TORPAD.....Replacement Pad

HEAVY-DUTY POLISHER

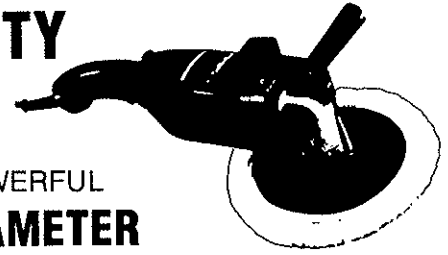

BALANCED POWERFUL
7" DIAMETER

Lightweight polisher, 1750 RPM used with standard liquid polishes. Standard equipment includes rubber backing pad and disc nut.

- URETHANE BUMPERS PROTECT GEAR CASE & HANDLE
- SPRING LOADED SPINDLE LOCK
- HELICAL GEARING
- SMOOTH RUNNING all ball and roller bearings
- ALUMINUM GEAR CASE
- SELF-STOPPING LONG LIFE BRUSH SYSTEM

U5455

NEW STRONG LIGHT WEIGHT NON-CONDUCTIVE GLASS REINFORCED NYLON MOTOR HOUSING AND HANDLE



3M Super Buff Pad

Twice the usable surface. Full contact on flat areas with fewer swirl marks. Built in backing pad assures balanced, non-skip, vibration free operation.

T5700 PAD
T5710 ADAPTER

3M "SUPERBUFF" 2 plus 2 PAD PART NO. T5701

This buffing pad is called the "2 plus 2" because it features 2 sides to buff with plus 2 major advantages.

- More flexible — Gets into tight areas and reverse curves more easily
- Longer life — Provides greater economics to your buffing operation

Heavy back up pads are eliminated by the "2 plus 2" pads own lightweight support system. Packed 24 pads per case.

SUPERBUFF POLISHING PAD PART NO T5705

The SUPERBUFF Polishing Pad is a double sided, soft edge polishing pad, specially designed for use with a polisher and glaze. Made of extremely fine fibers, the SUPERBUFF Polishing Pad produces a high gloss on paint surfaces. Other features include long life, flexibility, light weight and balance.

For compounding prior to glazing, one of the other SUPERBUFF Pads may be used. Packed 12 pads per case.

S&S PAD WASHER

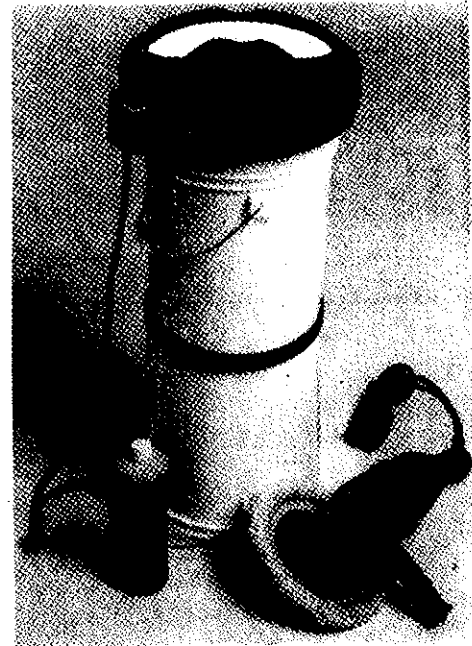

ADVANTAGES

SAVES TIME

- Buffing pad remains on the buffing machine while in use
- Machine is portable and may be used in any electrical outlet. Saves steps

SAVES MONEY

- Pad wax/polish residue quickly and thoroughly removed
- Cleaner pads last longer
- Only the pad's buffing surface is thoroughly cleaned, thereby eliminating warping and cracking of the back

MAKES PROFESSIONAL SENSE

- Revolutionary buffing pad cleaning system
- New wool blow-off and work area linting problems virtually disappear
- Makes hazardous dirty pad storage a problem of the past
- Pads remain lightly damp enhancing cutting and polishing results and reducing clear coat finish swirls and scratches

TPWM

GENERAL MERCHANDISE

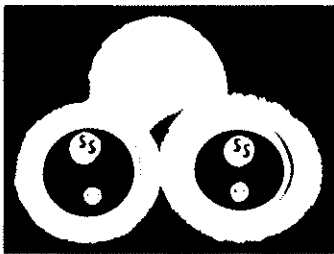

THE E-Z BUFF ADVANTAGE

The E-Z Buff is a round-edge buffing pad permanently mounted to a plastic back-up plate, which screws directly on to the power buffer. The threaded back-up plate provides "E-Z" mounting. The E-Z Buffs' direct mounting system of a balanced and centered back-up plate eliminates swirls and scratches while running true to the R.P.M. of the power buffer. The E-Z Buff System is ideally suited for high tech and clear-coat finishes.

- T876** 1½" Pile E-Z Buff Buffing Pad
T805 1½" Pile E-Z Buff Polishing Pad

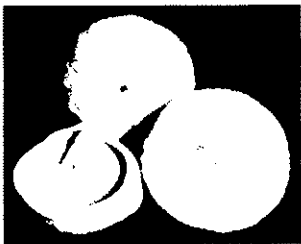

These extraordinary polishing pads are constructed of a proprietary blend of wool and a soft, but tremendously strong man-made fiber. Our heavy-duty construction make these pads exceptionally durable, and will last twice as long as lambswool pads. The extra-dense 1½ pile creates a softer, fluffier pad that adds a greater margin of safety when removing swirls from hi-tech and clear-coat finishes.

- T804** 1½" Pile x 8" Diam. Polishing Pad
T801 1½" Pile x 9" Diam. Polishing Bonnet



Designed for spot touch-ups, small scratches and swirl marks this 2" hi-density foam pad holds polish for minimum fly-out and is permanently mounted on a threaded plastic backing. Ideal for hi-tech and clear-coat finishes.

- T800** 8" x 2" Foam Pad



NATURALLY—THE BEST

Our 100% Tufted Wool Pad is sewn into a natural fiber back, then hand-trimmed to create a soft, pliable edge.

ADVANTAGES

- Eliminates Edge Burning
- Reinforced Arbor Hole Prevents Buffer Nut Slippage
- 100% Wool Pile Runs Cooler and Cushions Better
- Unique Backing Stands Up to Machine Washing
- Displaces heat from the vehicle service, therefore reducing the possibility of damaging today's softer paints.

- T875** 1½" Pile x 7½" Diam. Buffing Pad
T890 1½" Pile x 9" Diam. Buffing Pad



BUFFING PAD CLEANING SPURS

T5000

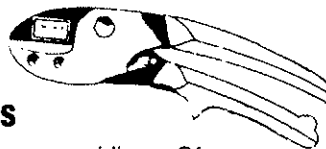

Molding Cutting Shears

Handyman's tool for car moldings. Offers maximum cutting ease. 8" overall length.

MCS1



Applicator Guns

Guns developed to provide a unique and convenient method of applying adhesives, glazing compounds, and sealers. Spray-type gun attaches easily to standard air lines and connectors.

- T8992** 1/10 gal. cartridge
T8994 pint can



TRADESMAN Heat Gun

For fast drying, softening, thawing and intermittent production work.

- T2Z387** Heat Gun
T2Z388 Replacement Element

GENERAL MERCHANDISE

FLUSHING MACHINE

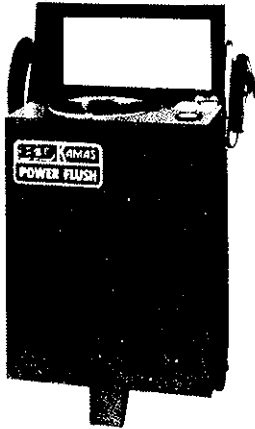

- All steel heavy duty construction
- Completely portable
- Water deflector to eliminate mess
- Stainless steel holding tank (Enables use of strong chemicals)
- Maintenance free
- One year factory warranty
- Single control for simple operation
- Operates with 12 Volt battery
- Operates with 12 Volt DC pump (1.5 Amps, 240 gallons per hour)
- Antifreeze must be changed frequently to prevent rust in the cooling system
- Effectively and efficiently cleans coolant systems
- Installs antifreeze without airlocks
- Power flusher is pressure regulated to 21 PSI to prevent any damage to cooling system parts
- Average cooling system service only 15 minutes

TPF100

MARQUETTE. HI-RATE CHARGER



Designed to be used by service stations, repair shops, auto/truck dealers, farms/ranches, etc. - wherever quality and performance are demanded. Handles all 6 and 12 volt battery charging jobs. Professionally charges calcium lead (maintenance-free), low antimony (low maintenance) and high antimony (deep cycle) batteries.



T39610

TWHEEL Replacement Wheels
TAXLE Replacement Axles

BLACKHAWK 2-Ton HYDRAULIC JACK

Capacity(tons)	Low Saddle Height	Max Saddle Height	Chassis Length	Handle Length	Weight
2(1814Kg)	5-1/8"	19-5/16"	26"	45-3/8"	85lbs

Full 90-degree pumping arc assures fast lifting. Wide stance and low center of gravity provide optimum stability under load stress. Specially-designed low-profile chassis lets you work in tight areas. Automatic overload valve protects cylinder from damage. Replaceable power unit speeds repairs and makes product maintenance routine work. Cast metal wheels and casters maximize durability and endurance. Two-piece handle is easily removed making for convenient storage and transportation.

T67424

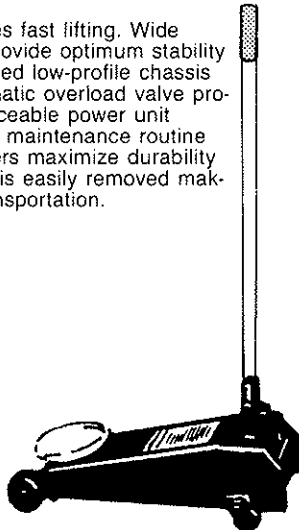

KWIK-START STARTER WITH AUTOMATIC CHARGER

Outstarts any fast charger 3 to 1. Roll anywhere starting power. Will start up to 24 vehicles without recharging. Plugs into A/C outlet to automatically recharge and maintain starter battery.

- 10 AMP automatic solid state charger with selector switch for standard and maintenance free batteries.
- Ventilated battery compartment with battery holddown straps.
- 500 AMP insulated "Safety Clamps" with flexi-spring cable guards.
- Patented "Safety Lite" alternator protection mounted in negative clamp.
- Accommodates battery" sizes up to HWD 10 1/4" x 7 1/4" x 9".
- Heavy duty 7 inch wheels.

• Starting battery not included.
Minimum 500 CCA, 160 reserve capacity.
Group 27 or 30H case size.

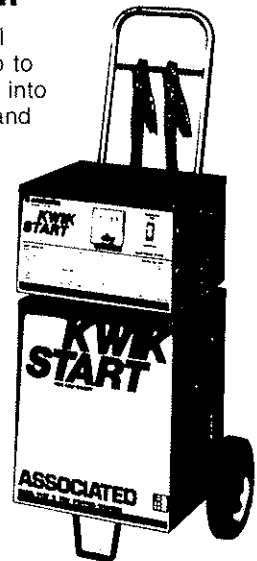

T6127KS

SPECIFICATIONS	
BOOST RATE @ 0 Volts	1100 AMPS
BOOST RATE @ 8 Volts	500 AMPS
AC INPUT @ 120 Volts	2 AMPS
AC CORD	10' 18-3
DC LEADS	8', 4 AWG
DIMENSIONS, HWD	25" x 11" x 15"
SHIPPING WT.	48 LBS.

GENERAL MERCHANDISE

TVT500 STORAGE CABINET



Technical Data

- Four shelves are provided with 72" high model and two with the 42" cabinet height model.
- Quick, easy shelf adjustment on 2" centers.
- Three-point locking device for maximum security.
- Flush front, back and sides allow side-by-side applications and backs may be exposed.
- Double doors swing open full 180° and maintain alignment with a full-width door pan-type reinforcement.
- Polished chrome-plated handle and a built-in grooved key lock are standard.
- Stock finish is Dove Gray or Putty (a light beige).

GENERAL MERCHANDISE

RAZOR BLADES

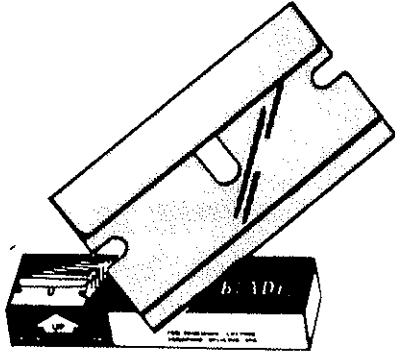

High quality blades fit all holders. Especially honed for industrial use. Longer lasting and more cuts per blade.

TRB 100/box

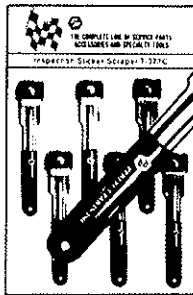

Sticker Scraper

Designed for the efficient removal of inspection stickers from windshields of late model cars. A handy tool for the removal of paint, varnish etc., from all types of glass surfaces.

T373B

Razor Blade Scraper

Quality steel scraper handle. Simple push-pull extension and retraction. Safety lock closing for safe storage. Made for use with single edge blades.

TRS23



MARSON Utility Knife

The professional tool for cutting, slicing, and trying jobs on masking tape, rubber seals, moldings, gaskets, vinyl, and carpeting.

X20315

KNIFE

X20316

BLADES 5/box

TUKB

BULK BLADES 100/box

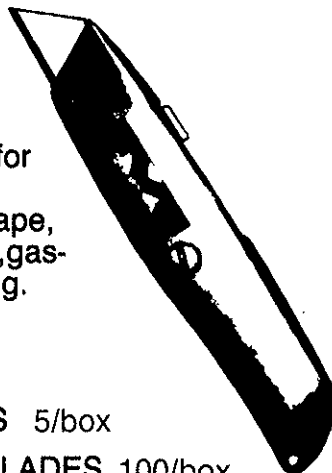

Steel Wool

10 large pads in a break-apart package.

T000 GRADE 000

T00 GRADE 00

T0 GRADE 0

T1 GRADE 1

T2 GRADE 2

T3 GRADE 3

GENERAL MERCHANDISE



NATIONAL Snow Brush

Tough red plastic scraper and handle. 7½" of blue poly bristles. 1-7/8" trim. 24/cs.

T1222

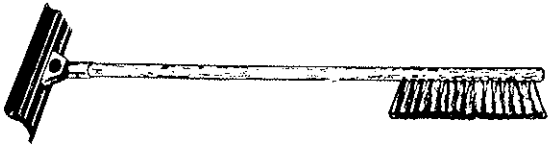

LAITNER Snow Brush & Squeegee

One piece scraper and squeegee, 24" laquered handle with row of blue poly bristles.

T1045 (Old# T1252)



ICE BREAKER

Hand crafted blade is precision sawed for best cutting angle and can tackle even the heaviest ice.

T1202

LAITNER Giant Bug Demon

With 24" handle. Double roll sponge completely enclosed with nylon mesh fabric bug and grime remover. 8" aluminum extrusion contains extra size poly sponge and flexible rubber squeegee that conforms to contoured glass.

T648 (Old# T196)

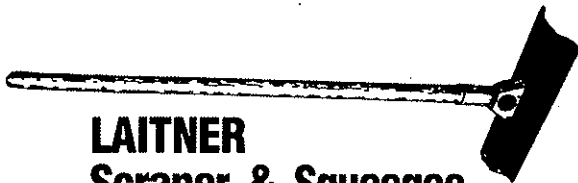

LAITNER Scraper & Squeegee

Cold-proof PVC one-piece scraper and squeegee, connects to handle with aluminum bracket. Clear lacquer wooden handle.

T1046 (Old# T1282)

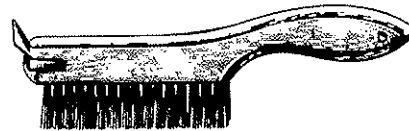

LAITNER Wire Brush w/Scraper

Shoe handle w/scraper. Woodgrain molded block with 1½" steel scraper.

T944L (Old# T83)

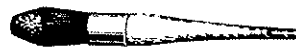

LAITNER Parts Brush

Vulcanized in rubber, has steel ferrule on handle.

T1002 Hog Bristle (Old# T86)

T1003 Nylon Bristle (Old# T87)



LAITNER Grill & Spoke Brush

Brush part tapers from 4" dia. to 1" at tip. 5" smooth handle with wire loop. Packed 1 doz. in carton shipper.

T970 (Old# T62)

GENERAL MERCHANDISE



LAITNER Whitewall Brush

Ideal for automotive use and for cleaning barbecue grills.

T935L Brass (Old# T65)

T937L Nylon (Old# T67)

LAITNER Wheel Brushes

Heavy-duty utility scrubs on 8-1/2" wood blocks. 2" trim in three fills. For use around homes, cars and boats.



T842 Brown Palmyra (Old# T50B)

T843 White Tampico (Old# T51)

T860L White Nylon (Old# T56A)

LAITNER Long Handle Wheel Brushes



Heavy-duty utility scrubs on 21" wood-grain molded blocks. 2" trim in 6 fills.

T852 White Tampico (Old# T58)

T854 Brown Palmyra (Old# T60)

LAITNER Whisk Broom



Corn fiber fill. Handle wire wrapped with ring.

T779 (Old# T80A)



LAITNER Fountain Brush

The original value-priced fountain washer. 10" x 2 1/2" brush made of 100% natural Tampico, 2-3/4" trim.

T1102 Brush (Old# T35)

T1104 Handle (Old# T35A)

LAITNER Hand Held Wash Brush

Filled with a blend of topgrade nylon and horsehair flanged and tipped.



T1118L (Old# T48)



LAITNER Wire Spoke Brush

Extra long bristles for cleaning of wire wheel covers.

T971 (Old# T62A)



LAITNER Detail Brush

For new and used car preparation, detailing and cleaning.

T4R

GENERAL MERCHANDISE

LAITNER Paint Brushes

Inexpensive disposable
utility paint brushes

OLD #

- T1005L** (T88PB) 1/2" Paint Brush
- T1006** (T89PB) 1" Paint Brush
- T1007** (T90PB) 1 1/2" Paint Brush
- T1008** (T91PB) 2" Paint Brush



LAITNER Threaded Handle

Hardwood- treaded handle.
Clear lacquer finish. Fits
all standard floor sweeps
and garage brushes.

T542 (Old# T148)

LAITNER Threaded Handle

Hardwood handle with
metal tip section
for added strength

T562 (Old# T152A)

Can be used in place
of No. T542 handle.



LAITNER Tapered Handle

Tapered end handle. Smooth
sanded finish. For street
brooms, deck scrubs, paint
sundry, window brushes and
squeegees.

T552 (Old# T148)



LAITNER Handle Brace

Outrigger brace.
Cadmium plated steel legs
fasten to handle with nuts
and bolts. Ends are screw-
ed into brush block.



T560 (Old# T156)

LAITNER Hand Brush

Perfect for carpeting, vinyl
tops and upholstery.



T865 (Old# T63)

LAITNER Acid Brush

Tin handle acid brush. filled
with stiff black horsehair.

T913 (Old# T77A)



LAITNER Wire Brush

Curved wood handle, 14"
block with 3 x 19 rows
of tempered steel wire.

T941 (Old# T81B)

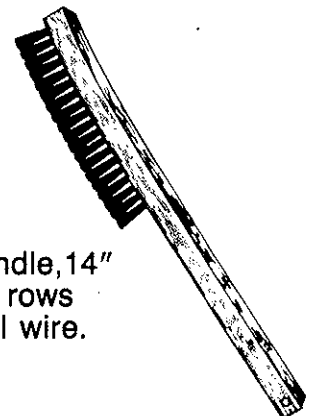

GENERAL MERCHANDISE

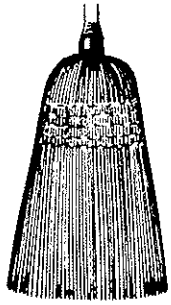

LAITNER House Broom

Commercial-grade 100% corn broom with 5 sewn reinforcements. lacquered 1-1/8" handle. 58" overall size.

T470 (Old# T136A)

LAITNER Floor Broom

Solid design filled with uniformly mixed Black Tampico, Black Horsehair and simulated Horsehair Synthetic.

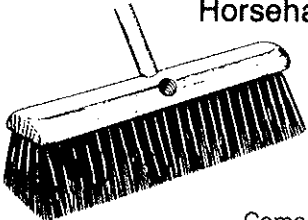

T318 16" (Old# T116)
T319 18" (Old# T117)
T320 24" (Old# T118)

Comes with T542 (Old# T148) handle.



LAITNER Floor Broom

Zephr synthetic-Dual fill broom has stiff broom Algyl center with border of lighter guage Algyl to control dust, 3-1/4" trim.

T446L (Old# T121)
 Comes with T552 (Old# T154) handle.

LAITNER Floor Broom

Triple-fill brush has a center row of steel wire, surrounded by two rows of Black Tampico and an outside row of horsehair reinforced with synthetic.

T463 (Old# T126)

Comes with T542 (Old# T148) handle.

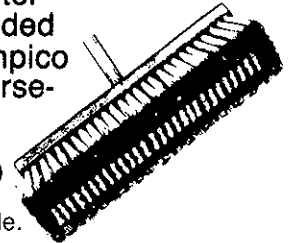

LAITNER Street Broom

Africa Bass heavy-fill 5 rows. 6-1/4" trim. A stiff and very durable broom, used by contractors and road builders. Sand finish block 3-1/2" x 1-3/4". Two tapered handle holes.

Requires T552 (Old# T154) handle.



T448
 (Old# T128)

LAITNER Garage Brush

Popular heavy-duty Brown Palmyra fiber, 4" trim. For wet or dry surfaces.

T203LB 18"
T298 24"
T299 36"

Comes with T542 (Old# T148) handle.

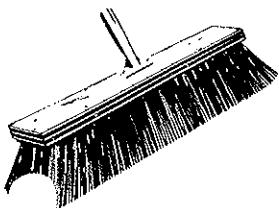

RUBBERMAID Heavy Duty Dust Pan

Won't rust, corrode, or dent. Smooth lip hugs floor for easy sweeping pickup.

N2006 Bronze

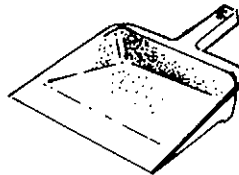

WHITE INDUSTRIAL PRODUCTS Dust Pan

White's most popular dust pan, "The Janitor", has a durable one piece

construction with corrugated ribs for added stiffness. Baked enamel finish with beveled edge. 20 gauge steel for hard usage.

N6 12" edge black

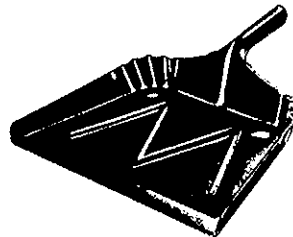

GENERAL MERCHANDISE

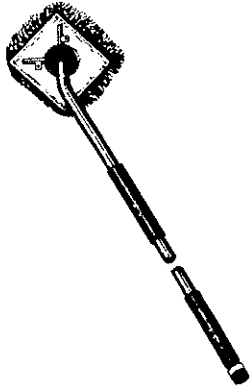

UNIQUE Wash Mop & Handle

Rugged, heavy-duty fountain mop for industrial, garage and home use.

T600M mop & handle

T600C mop head

T600R pad

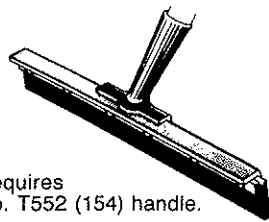

Requires No. T552 (154) handle.

LAITNER Floor Squeegee

Heavy-duty cadmium-plated steel frames and cast aluminum handle sockets. Rubber blades are 2" x 1/4" thick.

T565 (T141) 18" w/o handle

T142A 24" w/o handle

T145 36" w/o handle

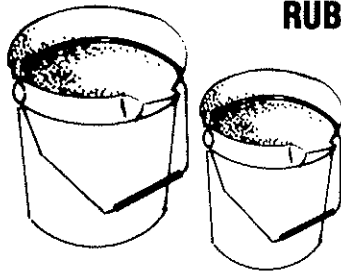

RUBBERMAID Brute Buckets

Rugged, injection-molded Brute buckets resist acids, alkalis, paints, chemicals and cleaning compounds.

N2963R 10 qt. red

N2614R 14 qt. red

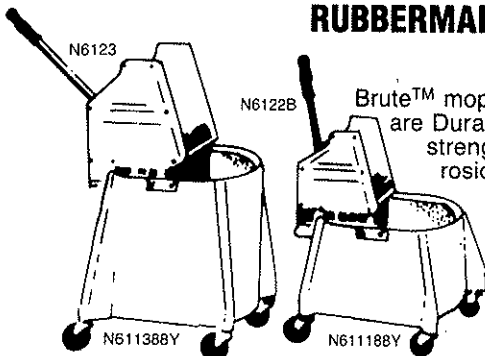

RUBBERMAID Mop Wringers and Buckets

Brute™ mop wringers and buckets are Duramold™ constructed for strength and durability. Corrosion resistant and impervious to germicidal cleaning solutions. Downward pressure wringers for tough, heavy-duty jobs.

N611188B	26 qt. Mop Bucket	Bronze
N611388Y	35 qt. Mop Bucket	Yellow
N6122B	24 oz. Mop Wringer	Bronze
N6123Y	36 oz. Mop Wringer	Yellow

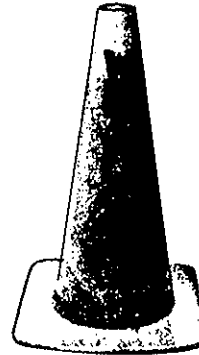

Wet Floor Sign

Here is the "Wet Floor" sign that can't be missed, with a bright orange surface and black letters. Durable one-piece molded plastic construction with weighted base for extra stability.

N13 18" high



COTTON Rawhide

Truly the "work horse" of the industry. An economical and durable cotton mop that resists the chemical reactions of cleaning solutions, while withstanding abrasion from rough surfaces. 8 ply.

NMH24 24 oz. mop head

NMH32 32 oz. mop head

Speed Change



The plastic Speed Change mop handle is corrosion free and non-marring. The swing-away retaining bar allows for simple and fast mop changing. The mophead is secured firmly in place by a rolled adjustment knob. Fiberglass.

N84 64" length

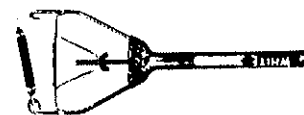

This speed change with its fall away retaining bar allows for simple and fast mop changing. Built for rigidity. All parts heavily electro-plated to resist rust.

N837MH 7" head 63" length

GENERAL MERCHANDISE

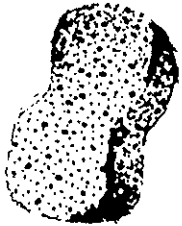

**FIGURE 8
CAR WASH SPONGE**
TFIG8



Water Sprite

An exclusive proven synthetic material that gently cleans and dries fine finished surfaces.

TWS546 21½" x 26"



Bug Sponge

Nylon. Does not scratch, won't rot. Long lasting.

T96N



Cleaning Mitts

Excellent for washing, dusting, and polishing. Elastic wrist. Super soft.

T85A Synthetic

T92B Professional High Pile



Genuine English Chamois

Hundreds of car wipes from each chamois. Leaves all surfaces sparkling clean.

TEH24



SIMULATED CHAMOIS

18 x 20

T0302

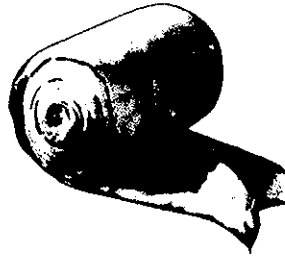

Beefcloth

Used for cleaning and waxing autos, trucks, boats, etc. For home, shop, and garage use.

TBC10 10 lb.

TBC25 25 lb.

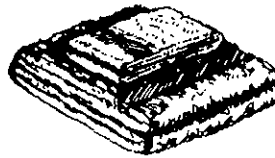

Wash Towels

High quality Turkish—made extra absorbent—towels. Multi-purpose.

TBC5

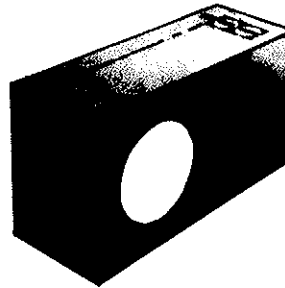

**FORT HOWARD
Windshield Wipes**

One towel cleans windshield, windows, headlights and tail lights. 2-ply.

T29390 blue 140/pk

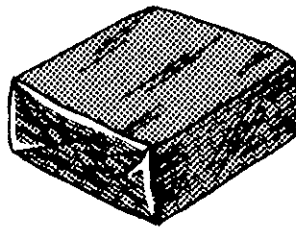

Shop Cloths

Heavy duty disposable wipers. Made of three-ply paper stock.

T29215 white

T29220 red

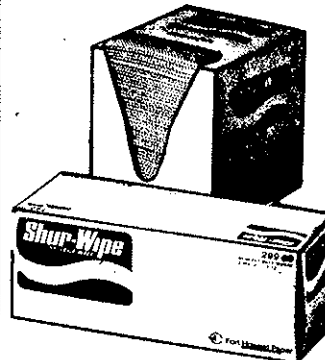

**FORT HOWARD
Disposable Towels**

Heavy duty. Combine excellent performance and economy. They have the strength, absorbency, size, softness, and pliability to replace cloth for even the toughest jobs.

T29920 gold

GENERAL MERCHANDISE

T137 BI-TEX

T120 STYLENE

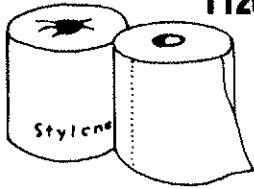

T56701

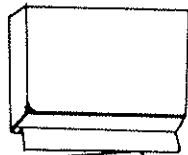

T209 TRUMP

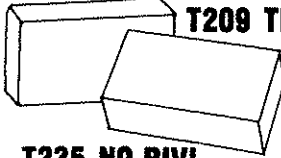

T235 NO-RIVL

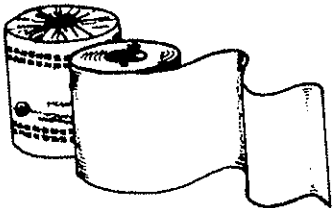

T104

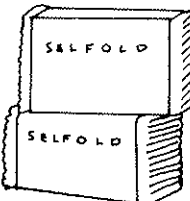

T233 NO-RIVL

T203 PALMER

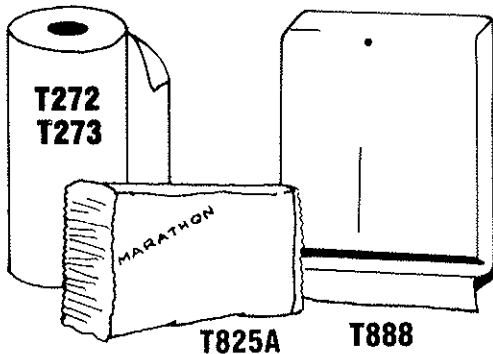

T825A

T888

T860

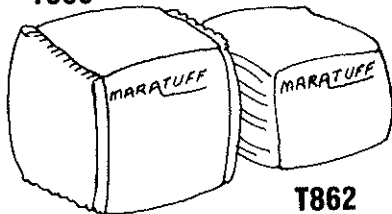

T862

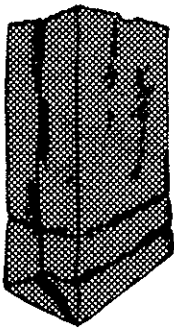

T47430 POM-ETTS

T28332

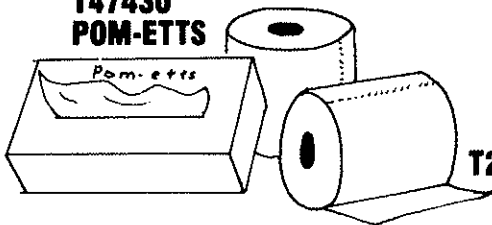

T284 PALMER



N8

TISSUE

T104 FORT HOWARD Single-ply. Superior softness, fast absorbency—48 rolls per case

T137 FORT HOWARD Bi-Tex bleached 2-ply roll tissue. 375 sheets per roll—96 rolls per case

T120 FORT HOWARD Stylene bleached 1-ply roll tissue- 1,000 sheets per roll-96 rolls per case

T47430 FORT HOWARD Pom-etts boxed facial tissue—8.33x8.7", 2-ply-30 boxes per case

TOWELS

T209 FORT HOWARD Trump bleached white single fold towels-9½x10¾-4,400 per case

T235 FORT HOWARD No-Rivl natural singlefold towels-9½x10¾-4,400 per case

T203 FORT HOWARD Palmer bleached multi-fold towels- 9¼x9½-4,400 per case

T233 FORT HOWARD No-Rivl natural multi-fold towels 9¼x9½-4,400 per case

T272 FORT HOWARD 1-ply perforated roll towel, 30 rolls per case 11x11

T273 FORT HOWARD 2-ply perforated roll towel, 30 rolls per case-11x11

T284 FORT HOWARD Palmer bleached roll towels, 7 7/8" roll-12 per case-625 ft. roll

T28332 FORT HOWARD Wiplot natural roll towels 7 7/8x625-12 rolls per case

T825A DIXIE/MARATHON C-fold towels, 10 3/8 x 13 3/8—2,400 per case

T860 DIXIE/MARATHON Maratuff multi-purpose wipes, white, 12½ x 13½—700 wipes per case

T862 DIXIE/MARATHON Maratuff shop towel, blue, 12½x13½—400 bulk pack

T56701 FORT HOWARD Dispenser for #T209, #T235

T888 DIXIE/MARATHON Dispenser for #T825A

MISC.

N8CUP Styrofoam cups, 8 oz.—1000 per case

PAPER BAGS

T1LB	1	lb.
T2LB	2	lb.
T5LB	5	lb.
T8LB	8	lb.
T10LB	10	lb.
T12LB	12	lb.
T16LB	16	lb.
T20LB	20	lb.

GENERAL MERCHANDISE

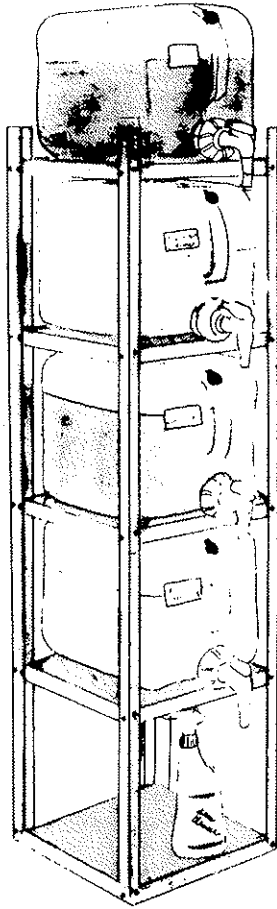

DISPENSING RACK

The ideal liquid storage system for cramped areas.

Organize in minimum space — requires only 12½" x 14" of floor space and is less than 5 ft. high when loaded with dispensing containers.

Store large quantities — You can store up to 20 gallons of liquids plus supplies.

Dispense from the rack — conveniently fill spray bottles or other containers directly out of the 5 gallon dispensing containers. No waste!

Strong and Safe — designed for stability and safety. It can support up to a 200 lb. load. The front load only feature eliminates accidental slippage through side or back. Solid and sturdy. Manufactured of heavy gauge coated steel to prevent rust.

Economical — SAVE SPACE, SAVE SUPPLIES, SAVE TIME AND ENERGY.

U420100 (SPECIAL ORDER • PLEASE ALLOW 2 WEEKS)

5 GALLON POLY CONTAINER WITH SPOUT

5 gallon polyethylene vented dispensing container with extended faucet to fill bottles with 24mm & larger neck openings. Molded in gallon graduations. Top handle and bottom finger grip. 63mm neck. Measures 13½" high x 9½" wide x 10" deep. Exceeds DOT 2U requirements.

U420812

FOUR OZ. ROUND DEODORANT BLOCKS

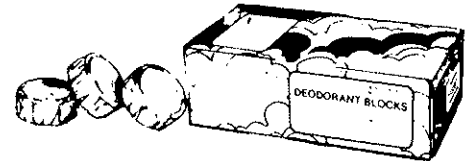

Made specifically for use in urinals for destroying objectionable odors. Each long lasting block is made from pure perfumed paradichlorobenzene formed under extreme pressure by automatic presses and wrapped in heat sealed, air tight cellophane.

Packed 1 doz. to a box, 1 gross to a carton, N972016



TOILET BOWL BRUSH N837B

Urinal Screens



Tough, durable and flexible. The flexo-screens lay flat for surface adherence with no edges to hang up. They keep cigarette butts, cigars, matches, and other foreign debris out of drains. Comes in sanitary blue. Special removal tool enclosed with each unit.

N9304 15/24 x 11 x 4

GENERAL MERCHANDISE

SURE SHOT RECHARGEABLE ATOMIZER SPRAYER

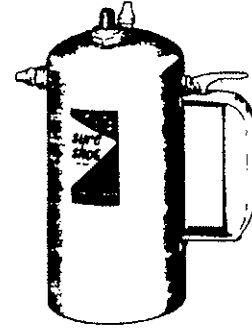

Atomizer sprayer provides economical bulk spraying in industrial, commercial and automotive applications. Spray lubricants, coatings, solvents, pesticides and more. Ensure controlled, uniform spraying action for better coverage than material mixed with aerosol propellants.

Chrome-plated brass for extra resistance to corrosive materials. Can be used with water and oil base, as well as some corrosive caustic materials.

Equipped with tire valve stem filler cap for use with standard air compressor tire chuck or tire pump.

T2000A.....Sure Shot Sprayer



MULTI-PURPOSE Spray Bottle

Multi-purpose trigger spray bottle for industrial, shop, and home use.

TSPB 16 oz.



MULTI-PURPOSE CRC-Sprayer

T14014 16 oz.



SPRAYMASTER

High Output
Chemically Resistant Sprayer

bottle features clear window stripe for easy, accurate, measuring using 3 graduation scales. Can be safely used with degreasers, strippers, weed killers, pesticides, solvents and many other chemicals.

TSM8700 32 oz.



SPRAY MIST Sprayers

High density polyethylene natural color.

TLGSPB 32 oz.

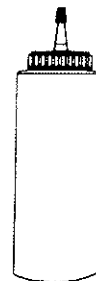

SQUEEZE BOTTLES

Low density, poly bottles.

T406SB 12 oz.

GENERAL MERCHANDISE

FIRST AID KIT

Designed to handle the first aid requirements of on-the-job locations. Unique AIDPAKS in the fill provide more high use material at lower cost.

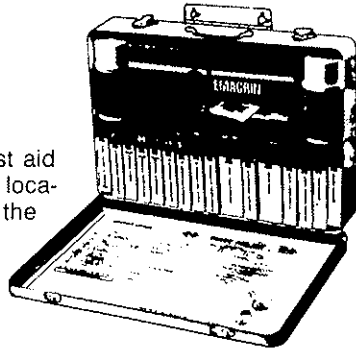

- TC11** 10 unit case/standard
TC21 16 unit case/standard

FIRST AID REPLACEMENT PACKAGES

PART #	DESCRIPTION
ANTISEPTICS	
TC100	Obtunda Antiseptic Swabs Burntame Spray 3½ oz.
BANDAGES	
TC300	Plastic Strips 1" x 3"
TC303	Plastic Strips 2" x 4"
SPECIALTY ITEMS	
TC400	Adhesive tape 1/2" x 2 yd.
TC412	Ammonia Inhalants .33cc
TCC420	Trisol Eye Irrigation 1 oz.
TCC451	Instand Cold Pack
TC461	Emagrin Pain Relief Tablets
TC463	Sore Throat Lozenges
TC464	Banacid-Antacid Tablets
TC469	Heatrol Salt Tablets
TST800	Salt Tablet Dispenser 500
TS10	First Aid Spray 3½ oz.
QUANTITY SIZES 100 PER PACK	
TAP500	Obtunda Antiseptic Swabs
TAP561	Emagrin Aidpak
TAP562	Aspirin Aidpak
TAP700	Plastic Strips 1" x 3"
TAP701	Plastic Strips 3/4" x 3"



Complete Poly-Plastic
Face Shield
MODEL No. T54-102
Clear

T54110
Clear Shield Only

Dry Chemical BC FIRE EXTINGUISHER



For use in controlling fires caused by cooking oil, grease, gasoline, motor oil, solvents, and live electrical equipment.
T210DFC

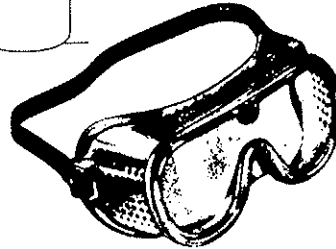

Soft Vinyl Impact Goggles

Coverall style soft vinyl goggles molds to all faces comfortably and may be worn over prescription glasses. Frame perforated for full ventilation. Large, one-piece plastic lens offers wide vision and is easily replaced. Recommended for protection against flying particles.

N40066

MARQUETTE® WELDING ACCESORIES

Tip Cleaner Kit

Careful cleaning of welding tips assures best welding flame and long tip life. Twelve scientifically designed stainless steel reamers come in handy aluminum case. Drill sizes are from 49 to 75.

T26321



Single Flint Torch Lighter

Long-life lighter with generous flint and rotating wear-resistant file. Uses low-cost replaceable flints.

T26313

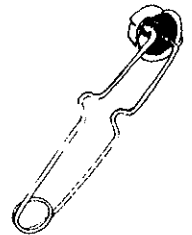

Double-Line Hose

Eliminates Kinking and Tangling

Tightly braided rayon lines for strength... neoprene base cover for oil and flame resistance. Hose with connections to fit all makes of torches and regulators.

Inside Diameter	Length	Model No.	Connections	
			Torch	Regulator
3/8"	20 ft.	T26012	1/4"	1/4"

GENERAL MERCHANDISE

BUFF COLORED CAN LINERS

A full line of sizes available
 Quiet, leakproof, odor free and sanitary refuse
 collection systems for faster, neater and less
 expensive trash disposal. Costly cleaning and
 replacement of cans is eliminated.

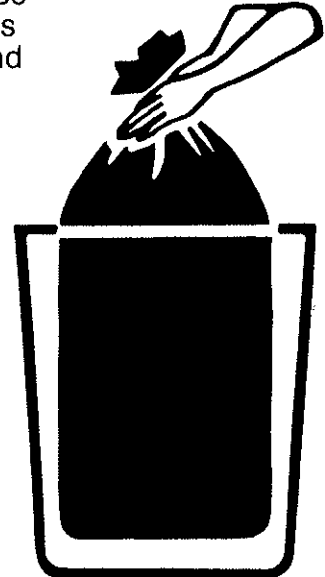

ITEM	SIZE	PACKAGE	CAPACITY	COLOR
NPG22410	15 x 9 x 23	1000	7-10 gal	BUFF
NPG23310	15 x 9 x 32	1000	12-16 gal	BUFF
NPG23720	16 x 14 x 36	250	20-30 gal	BUFF
NPG24030	20 x 13 x 39	250	33 gal	BUFF
NPG24830	23 x 17 x 46	125	40-45 gal	BUFF
NPG26030	22 x 14 x 58	200	55 gal	BUFF

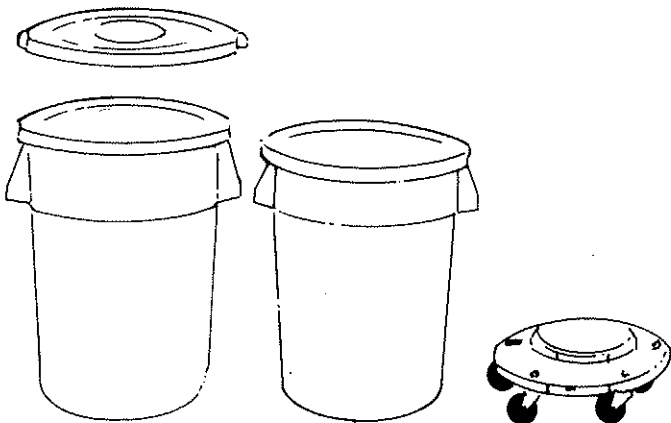

- N2632GR** 32 Gal. Container
- N2640** Dolly For Brute Container
- N2643GR** 44 Gal. Container
- N2655GR** 55 Gal. Container

- Gray
- Gray
- Gray

Rubbermaid offers a complete line of waste receptacles for any industrial requirement. All are lightweight, silent and easy-to-clean. Won't rust, dent, or crack.



Wastebasket

- N2956GR**
- Gray
- Medium

GENERAL MERCHANDISE

MAGID® GLOVES

- NG80** WING THUMB, knit wrist, clute.
- NG6000** Superior quality import, 8 oz. canton flannel, navy knit wrist.
- NT83** Superior quality import, 8 oz. canton flannel, black knit wrist.
- NG6050** Clute, knit wrist, Heathertone jersey, brown.
- NG6201** Top quality import.



NG80

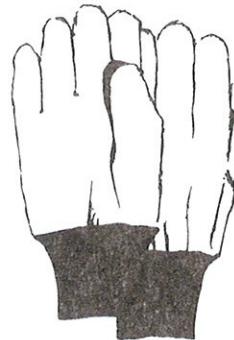

**NG6000
NT83**

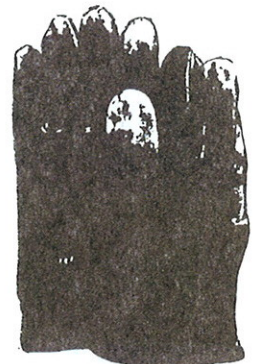

NG6050

- TG47** Rubber Gloves for use in most water solutions of acid, alkalies, salts and ketones.



TG47



NG815



NG6201



Rubber Apron

Reinforced with leather and metal strap grommets.

TA46

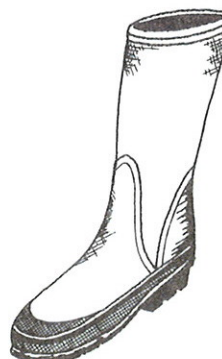

Rubber Boots

Premium quality pull-on, over the she boot. Self supporting 12" leg with stretchable lining. Easy on—easy off. Recommended for station workers, contractors, utility men.

TTRP110 Size 10
TTRP112 Size 12

TAPES

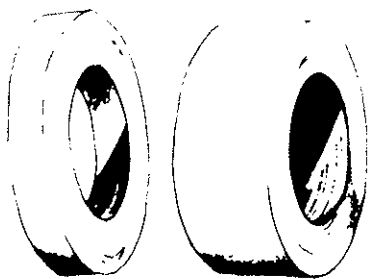

MASKING TAPE

Nashua
T75MT 3/4"
T2MT 2"

Conformable, hugs curves & contours. Quick, easy application, sticks at a touch and stays put.



Air Conditioning Tacky Tape

Two-sided, sticky black insulation tape. For insulating air conditioning lines.

T147002



SCOTCH Fine-Line Tape

Has special processed film backing that allows taping over freshly painted acrylic lacquer or enamel surfaces. Not designed for outdoor application.

T6300 1/8"x60 y
T6301 1/4"x60 y
T6306 1/16"x60 y

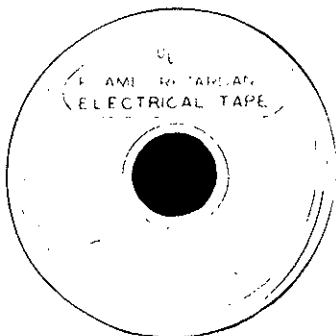

ELECTRICAL TAPE

Flame retardant, cold and weather resistant P.V.C. insulating tape. UL listed complying with CSA standards.

TUL33 3/4" x 33ft.
TUL66 3/4" x 66ft.

Teflon Pipe Thread Sealant Tape

Molds into pipe threads forming a leak-proof seal. Works on any automotive line. Resists oil, transmission fluid, and freon. Never dries out.

T6195 1/2" x 260"

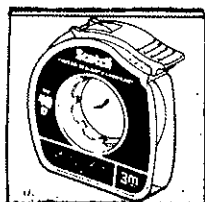

Box Sealing Tape

Strong film tape. Excellent for box sealing and other heavy-duty packaging applications.

T6879X Tan
T6874X Clear
T2CL
T2TAN

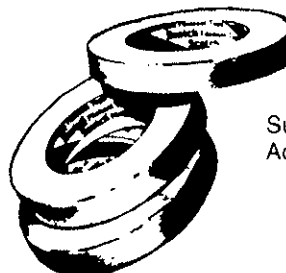

Filament Tape

Super strength; won't break or tear. Adheres instantly.

T6901 3M 3/4"
TMT94 Nylon 3/4"

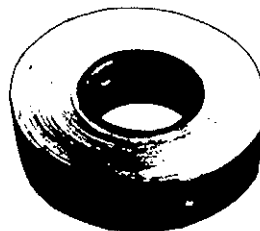

NASHUA Cloth Tape

This new cotton product is designed to give you what you'd expect from a utility tape... PLUS the features of a professional grade product.

T357 2" Premium Grade
T395 2" Economy Grade



NASHUA Weatherstripping

Adhesive-backed weatherstripping tape. Used to cushion, protect, seal, prevent slippage and insulate.

T80N 1/2" 5/32" 50'
T84N 3/4" 5/32" 50'
T88N 1" 5/32" 50'
T90N 1/2" 5/16" 50'
T94N 3/4" 5/16" 50'

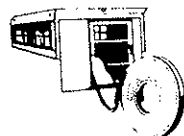
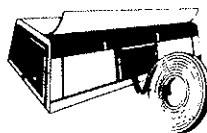

TAPES

WETORDRY Fabricut Rolls

WETORDRY Fabricut Rolls are made from a flexible, synthetic open mesh screen type backing that has been coated on both sides with tough aluminum oxide mineral. It is ideal for cleaning rusted or corroded surfaces. The open mesh construction allows the sanded residue to filter through. It can be used with or around water, oil, or axle grease without loading. Since both sides of the backing are coated with mineral, service technicians can sand mechanical parts with either side of the abrasive.

Part No.	Grit	Size	Rolls Per Case
T 5072	120	1 1/2' x 25 Yds	10

SCOTCH Vinyl Plastic Electrical Auto Tape No. 81

SCOTCH Auto-Electric Tape is the first plastic electrical tape specifically designed for use on auto repairs. Even if your fingers are greasy, this tape gets jobs done quickly. Use for splicing wires, harnessing cable, wrapping hoses and countless other shop jobs.

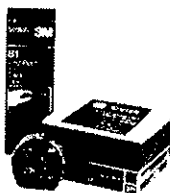

Part No.	Size	Rolls Per Box	Rolls Per Case
T 6100	3/4" x 20 ft.	10	100
T 6101	3/4" x 60 ft.	10	100

Super 33 Plus Vinyl Plastic Electrical Tape

Super 33 Plus is the first and only 7-mil "one tape for all jobs." It wraps and holds in all weather and will continue to perform in sub-zero temperatures or in continuous temperature environment up to 105° C (220° F). Super 33 Plus conforms remarkably and is resistant to oil, water, wear, chemicals and solvents.

Part No.	Size	Rolls Per Box	Rolls Per Case
T 6133	3/4" x 52 ft.	10	100

SCOTCH-MOUNT Automotive Attachment Tape

A closed cell foam tape coated on both sides with a pressure-sensitive adhesive. It is designed for attaching automotive trim molding emblems and other articles where high internal strength is required.

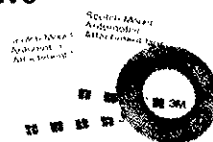

Part No.	Size	Rolls Per Case
T 6377	1/2" x 20 yds. Boxed	12
T 6378	1" x 20 yds. Boxed	12

SCOTCH-MOUNT Super Automotive Attachment Tape

SCOTCH-MOUNT Super Automotive Attachment Tape has acrylic adhesive on both sides for excellent adhesion in critical applications such as fascia nerf strips and body side moldings. This attachment tape also provides excellent adhesion to all OEM and aftermarket paint systems, especially the high solids lacquers found on all GM cars.



Part No.	Size	Rolls Per Case
T 6380	1/2" x 20 yds. Boxed	12
T 6381	1" x 20 yds. Boxed	12

SCOTCH Automotive Refinish Masking Tape No. 233

The superior masking tape designed expressly for the professional auto refinish painter. No. 233 is conformable, hugs curves and contours, goes on quick and easy, sticks at a touch and stays put. every feature perfectly balanced to give outstanding masking results.

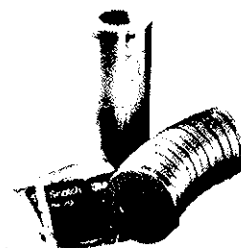

Part No.	Size	Rolls Per Case
T 6332	1/8" x 60 yds. Bulk	72
T 6334	1/4" x 60 yds. Bulk	48
T 6335	3/8" x 60 yds. Bulk	48
T 6336	1" x 60 yds. Bulk	36
T 6338	1 1/2" x 60 yds. Bulk	24
T 6340	2" x 60 yds. Bulk	24
T 6341	3" x 60 yds. Bulk	12
T 6343	1/2" x 60 yds. Boxed	12
T 6344	1" x 60 yds. Boxed	12

SCOTCH-MOUNT Grey Super Automotive Attachment Tape

SCOTCH-MOUNT Grey Super Automotive Attachment Tape has acrylic adhesive on both sides for excellent adhesion in critical applications such as fascia nerf stripes, bumper trim, wheel lip moldings and door edge moldings. Because of its grey color, this tape "blends in" and is less noticeable. This tape provides excellent adhesion to all OEM and aftermarket paint systems.

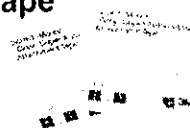

Part Number	Per Box	Quantity Per Case
T 6382	1/2" x 20 yds.	12

TAPES

SCOTCH Brand #471 Plastic Tape – Blue

This uniquely constructed vinyl backed tape offers outstanding paint line definition along with superior holding power for critical masking operations including sharp curves, over rivets and into seams. The tape is packaged in individual poly bags.

Part Number	Size	Rolls Per Case
T 6404	1/8" x 36 yds	12
T 6405	1/4" x 36 yds	12
T 6408	1/2" x 36 yds	12
T 6409	1" x 36 yds	12

SCOTCH Plastic Tape

For lane and stall marking, protecting, mending, color coding parts and pipe or hose lines. Retains true color brightness for prolonged periods. 12 rolls per case

Scotch 3M

Plastic Tape
No. 471

Part No.	Size	Color
T 6420	2" x 36 yds Boxed	Yellow
T 6423	2" x 36 yds. Boxed	Green

SCOTCHMATE Hook and Loop Fastening System

The SCOTCHMATE Hook and Loop Fastening System is comprised of two, 1" x 12" woven nylon strips, one strip of hook material and one of loop material,



that mate together to hold items securely in place. Each strip is backed with a premium quality pressure sensitive adhesive that is designed to meet the high and low temperature of demands encountered in automotive applications. Each SCOTCHMATE Hook and Loop package contains 12 mated strips and can be used for counter or pegboard display.

Part Number	Per Box	Quantity Per Case
T 6480	12 - 1" x 12" Mated Strips	6

SCOTCH ATG Adhesive Transfer Tape No. 924 (2 mil) SCOTCH ATG Adhesive Transfer Tape No. 969 (5 mil)

The Adhesive Transfer Tapes hold, attach, bond, laminate, tab, join, fasten, mount, splice or seal nearly any surface – paper, foils, films, fabrics, glass, foams, plastics, metal, painted surfaces and wood. These tapes are thin and tacky on both sides. One side adheres to applied surface, the other side is immediately ready to join a second surface. The adhesive provides instant tack and strong constant bond.

Part No.	Tape No.	Size	Rolls Per Case
T 6491	924	1/2" x 36 Yds.	72
T 6492	924	3/4" x 36 Yds.	48
T 6493	969	1/2" x 18 Yds	72
T 6494	969	3/4" x 18 Yds	48

SCOTCH Printable Flatback Tape

A printable Flatback Masking Tape to be used for shelf labeling, bin marking, and packaging identification.

Part No.	Size	Color	Rolls Per Case
T 6875	1/2" x 60 yds	White	12

SCOTCHPRO Box Sealing Tape

(No. 3750 Tape Construction)

A strong film tape that is excellent for box sealing, re-cooperation, fiber drum sealing and other heavy-duty packaging applications. Available in 1 1/2" and 2" widths in Tan and Transparent



Part No.	Size	Color	Rolls Per Case
T 6874	2" x 60 yds	Trans	36
T 6879	2" x 60 yds	Tan	36

SCOTCH LABELGARD Tape

(No. 8210 Tape Construction)

LABELGARD Tape is designed for the attachment and protection of address labels on a wide variety of shipping and mailing containers.

Part No.	Tape No.	Size	Quantity Per Case
T 6889	8210	5" x 72 yds	8

SCOTCH Filament Tape

(No. 895 Tape Construction)

A transparent polyester film backed tape that provides adequate strength for most closing, reinforcing and bundling applications

Part No.	Size	Rolls Per Case
T 6901	1" x 60' yds. bulk	48

SCOTCH Hand Dispensers

Part No. T 6908 for 2" Tape

Provides a quick, easy and inexpensive method for sealing cartons with 1 1/2" or 2" wide rolls of SCOTCH Box Sealing Tape. Lightweight, quick loading, and features metal cutting edge for long life. Packed 6 in a carton.



H-10 Filament Tape Dispenser

Part No. T 6910

Accommodates all listed widths of filament tapes shown. Packed 6 per carton.



One Hand Box Sealer

Two surfaces for good adherence.

T6912



H-122 Box Sealing Dispenser

Part No. T 6925

A lightweight and durable hand dispenser for box sealing tapes. Accommodates tape up to 2" wide. Packaged 6 per case

GENERAL MERCHANDISE

SCOTCH ATG 752 Dispenser

Part No. T 6927

This dispenser is designed for use with our SCOTCH ATG Tapes for easy dispensing. Packed 6 per case.



M-727 Packing List Tape Dispenser

Part No. T 6944

Designed to accommodate both our Packing List Tape and our LABELGARD Tape. Accepts tapes up to 5" wide. Unique streamline construction allows for wall or bench mounting. Packed six (6) per case.

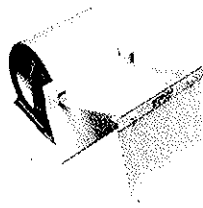

H-171 Box Sealing Dispenser

Part No. T 6955

Provides a quick and easy method for dispensing Box Sealing Tape directly from the roll. Accommodates tape widths up to 2". Packed 6 per case.

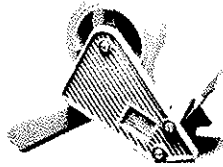

SCOTCH Packing List Tape (No. 8240 Tape Construction)

The see-through SCOTCH Packing List Tape provides a tight seal for documents during shipment, protecting them against being torn off or lost. It is scuff, moisture and abrasion resistant and is convenient and economical to use.

Part No.	Pouch Size	Pouches Per Roll	Rolls Per Case
T 6947	5" x 6"	500	8

POST-IT Removable Labeling Tape

POST-IT Removable Labeling Tape is a white, general purpose labeling tape that is easily removable. Use for shelf and bin marking, and package identification. POST-IT Removable Labeling Tape also works great for correction and cover-up work.

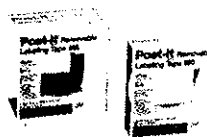

Part No.	Roll Size	Rolls Per Case
T 6950	3/4" x 36 yds.	48
T 6951	2" x 36 yds.	24

SCOTCH Cloth Tape (No. 390 Tape Construction)

This tape is designed for applications calling for medium strength and moisture resistance. It has very high instant adhesion. It is used for sealing, patching, and a variety of repair applications where flexibility, conformability, and a moisture-proof tape is required. The silver tape can also be used for a variety of automotive air conditioning and heater line sealing applications. Colors: Olive Drab and Silver.

Part No.	Size	Rolls Per Case	Color
T 6974	4" x 60 yds. Bulk	12	Olive

3M Brand 6998 Respirator

3M Brand 6998 Respirator is 3M recommended for automotive undercoating. It is NIOSH MSHA approved* for use against dusts and mists with a PEL (permissible exposure limit of .05mg m3 of air. Provides relief from nuisance odors experienced during most undercoating and rustproofing operations. The 6998 Respirator is lightweight, maintenance-free, easy to breathe through and allows clear communication when speaking in normal tones. Read all product instructions and warnings prior to use.

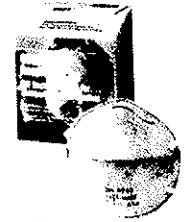

Part No.	Respirators Per Box	Boxes Per Case
T 6998	10	6

*06998 is part no. only. Reference to NIOSH MSHA approval is for 9913 Respirator

SCOTCH-BRITE Light Duty Cleansing Pad No. 98

These pads can be used to clean rusty, corroded surfaces. They are conformable so hard-to-get-at contoured surfaces are easy to reach and because of the open web non-loading construction, they can be easily cleaned and used again.

Part No.	Pads Per Box	Boxes Per Case
T 7445	10	6

SCOTCH-BRITE General Purpose Pad

Part No. T 7447

For scuffing before applying paint and Primer-Surfacer. For used car reconditioning, cleaning upholstery, headliners, doorpads, chrome and cleaning of white wall tires. Made of nylon web — rinse clean — can be used over and over again.



SCOTCH-BRITE Ultra Fine Pad

Part No. 07448

For final sanding of Primer-Surfacer — Sand the Primer-Surfacer with WETORDRY TRI-MITE Paper Grit 360A — Rub the Primer-Surfacer across the sandscratch with a SCOTCH-BRITE Ultra Fine Pad. Made of nylon web — rinse clean — can be used over and over again.

Part No.	Pads Per Box	Boxes Per Case
T 7447	20	3
T 7448	20	3

SCOTCH-BRITE Surface Conditioning Discs

Made of non-woven nylon fibre material impregnated with aluminum oxide mineral, the SCOTCH-BRITE Surface Conditioning Disc is ideal for cleaning light oxidation and removing gasketing residue from a wide variety of surfaces that include engine blocks, heads, valve covers and transmission housings.

Part No.	Grit	Size	Discs Per Bag	Bags Per Case
T 7450	Coarse	4" x NH	10	10
T 7451	Medium	4" x NH	10	10
T 7458	Coarse	2" x NH	50	4
T 7459	Medium	2" x NH	50	4

GENERAL MERCHANDISE

SCOTCH-BRITE Clean 'N Strip Discs

The SCOTCH-BRITE Clean 'N Strip Disc is an open mesh disc made from a tough, abrasive impregnated material. The perfect alternative to wire brushes for tough cleanup jobs on almost any type surface.

Part No.	Size	Discs Per Bag	Bags Per Case
T 7460	4" Diameter	10	3

3M Wheel Mandrel

Part No. T 7491

Wheel rounded for use with SCOTCH-BRITE Clean 'N Strip Discs. Mandrel size is 2" long with 1/4" shank. Includes locking washers. Packed 1 per bag.

SCOTCH-BRITE Disc Pad

This disc pad connects quickly and easily to any power tool while holding SCOTCH-BRITE Surface Conditioning Discs securely and safely through the use of SCOTCHMATE Dual Lock Fastening System.

Part No.	Size	Quantity Per Case
T 7492	For 4 In. Discs	5
T 7494	For 2 In. Discs	10

SAFETY-WALK Conformable Anti-Slip Surfacing Rolls

A new anti-slip surfacing material that can be bent, rolled or angled to fit any uneven or smooth surface. Sticks tight to any clean, dry surface. Provides positive grip even when exposed to water, grease and oil.

Part No.	Size	Quantity Per Case
T 7510	2" x 60 ft.	6

CHEMICALS

SECTION 6

PAGE

ACID RAIN REPAIR SYSTEM:	
Fallout Compound.....	9
Neutraseal.....	8
Stain Remover.....	5
ADHESIVES:	
Emblem.....	31
Spray.....	31
Structural.....	31
Top and Trim.....	31
ADHESIVE CLEANER.....	35
AEROSOL PAINTS.....	1
AIR BRAKE ANTI-FREEZE.....	19
ALL PURPOSE CLEANERS.....	5,30
ANAEROBICS.....	15
ANTI-FREEZE.....	27
Air Brake.....	19
Gas Line.....	19,22
Windshield.....	19,23,27
ANTI-SEIZE COMPOUND.....	14
APPLICATOR GUNS.....	35
ASSEMBLY LUBE.....	15
BATTERY CLEANER.....	21
BATTERY CORROSION PREVENTIVE.....	21
BATTERY ACID.....	25
BEARING GREASE.....	23,24
BELT DRESSING.....	25,35
BIODEGRADABLE CLEANER.....	5
BIODEGRADABLE SOLVENT.....	5
BOWL CLEANER.....	11
BRAKE CLEANER.....	2,15,18,20,21,34
BRAKE FLUID.....	18,25
BRAKE LUBE.....	24
BUFFING COMPOUNDS.....	6,8,30
BUMPER PAINTS.....	29
CARB & CHOKE CLEANER.....	1,15,17,20,22,34
CAR WASH, LIQUID.....	7
CAR WASH, POWDERED.....	9,20,23
CHAIN & CABLE LUBE.....	23
CHANNEL BONDING ADHESIVE.....	32
CHROME POLISH.....	12
COLD BONDING COMPOUND.....	16
COMPOUNDS.....	6,8,31
CONCRETE CLEANER.....	9,23
CONTACT CLEANER.....	21
COOLING SYSTEM CONDITIONER.....	19,22
COOLING SYSTEM FLUSH.....	19,22

COOLING SYSTEM SEALERS.....	19
COSMOLINE REMOVER.....	7
CRC.....	21
DEFOGGER REPAIR KIT.....	16
DEGREASER.....	5,18,20,21
DE-ICER.....	23
DEODORANT.....	5
DETERGENT.....	9
DIESEL CONDITIONER.....	17
DISC BRAKE QUIET.....	14,21
DRY LUBE.....	35
ELECTRIC MOTOR CLEANER.....	3,21
ELECTRIC PARTS CLEANER.....	15
EMBLEM ADHESIVE.....	31
ENGINE ADDITIVE.....	17
ENGINE DEGREASER.....	5,20,21
ENGINE GLAZE.....	9
ENGINE SHAMPOO.....	4
EPOXY.....	16
FLAT FIX.....	27
FLOOR CLEANER.....	9,23
FLOOR SOAP.....	9
FLOOR SWEEP COMPOUND.....	25
FORM-A-GASKET.....	13
FORM-A-THREAD.....	15
FREON.....	27
FUEL ADDITIVE.....	17,20
FUEL INJECTION CLEANER.....	17,34
FUEL INJECTOR CLEANER ADAPTORS.....	35
FUEL TREATMENT.....	17
GAS TREATMENT.....	17
GASKET ADHESIVE.....	13,14,33
GASKET-COPPER.....	14
GASKET ELIMINATOR.....	13,15,33
GASKET DRESSING.....	14
GASKET REMOVER.....	14
GASKET SEALANT.....	13,14,33
GAS LINE ANTI-FREEZE.....	19,22
GE SILICONE.....	27
GLASS CLEANER.....	3,4,20,27
GLAZES.....	7,8,9,30
GLAZING COMPOUND.....	31
GOLD EAGLE.....	22,23
GREASE:	
Cartridges.....	24
Dielectric.....	14
Gear Grease.....	24
Motor Assembly.....	24
Red Grease.....	3
Wheel Bearing Grease.....	23,24
White Lithium Grease.....	2,18,34,35
GREASE REMOVER.....	5
HAND CLEANER DISPENSERS.....	10,11
HAND CLEANERS.....	10,11
HAND LOTION.....	11
HAND SOAP.....	11

HYDRAULIC JACK OIL.....	14
ICE MELT.....	25
INJECTOR ADDITIVE.....	20
INTERIOR DEODERANT.....	5
INTERIOR PAINTS.....	29
LAUNDRY DETERGENT.....	9
LAMPS-LEAK DETECTION.....	26
LEAK DETECTION SYSTEM.....	26
Air Conditioning.....	26
ATF.....	26
Coolant.....	26
Fuel.....	26
Oil.....	26
LEAK DETECTOR.....	27
LENS REPAIR KIT.....	16
LIFT OFF.....	15
LITHIUM GREASE.....	2,18
LOCK FLUID.....	25
LOCK THAW.....	23
LOCTITE.....	13-16
LUBRICATING COMPOUND.....	24
LUBRIPLATE.....	23,24
MAG/CHROME POLISH.....	12
MAG WHEEL CLEANER.....	4,12
MINERAL SPIRITS.....	9
MIRROR ADHESIVE.....	16
MUFFLER CEMENT.....	27
NOCO.....	21
OIL ADDITIVES.....	20
OIL DRY.....	25
PAINTS, SPRAY.....	1,29
PARTS CLEANER.....	14,21
PASTE WAX.....	16
PENETRATING LUBE.....	2,18,20,21,34,35
PENRAY.....	17-20
PERMATEX.....	13-16
PIPE SEALANT.....	15
POLISH.....	7,8,9,30
POWER STEERING FLUID.....	18,25
PRIORITY ONE.....	12
RADIATOR SEALANT.....	23
REAR VIEW MIRROR ADHESIVE.....	16
RED GREASE.....	3
REFRIGERANT.....	27,28
REFRIGERANT FLUSH.....	28
REFRIGERANT LUBRICANT.....	28
REFRIGERANT OIL.....	28
REFRIGERANT VACUUM PUMP OIL.....	28
RELEASE AGENT.....	35
REPAIR KITS.....	16
ROCKER SCHUTZ.....	33
RTV SILICONE.....	13,33
RUBBER LUBE.....	23
RUBBERIZED UNDERCOAT.....	3,18,33
RUBBING COMPOUNDS.....	6,8,30

RUST FIGHTER.....	34
SCOTCH GUARD.....	35
SEAM SEALER.....	31-33
SHAMPOO.....	6
SIL GLYDE.....	24
SILICONE:	
Adhesives.....	13,14,27,33
Silicone Gasket Materials.....	13,14,27,33
Silicone Spray.....	1,18,20,22,35
SIMPLE GREEN.....	5
SNAP A CAN ADAPTOR.....	28
SOLVENTS.....	5,9
SPARKLE.....	27
SPOT REMOVER.....	15
SPRAY PAINTS.....	1,29
STARTING FLUID.....	19,22
STOP LEAK.....	23
STRIP CAULK.....	32
STRIPE REMOVER.....	34
SUPER BONDER.....	16
SUPER GLUE.....	16
SUPER GLUE REMOVER.....	16
SWIRL MARK REMOVER.....	6
TAR REMOVER.....	5,20
THREAD LOCKER.....	15
3M.....	30-35
TIRE CEMENT.....	27
TIRE DRESSING.....	4
TIRE SEALANT.....	27
TRANSMISSION SEALER.....	17
TRIM ADHESIVE.....	31
ULTRA SLICK.....	15
UNDERCOAT-RUBBERIZED.....	3,18,33
UPHOLSTERY CLEANER.....	6
URETHANE.....	32
VALVE GRINDING COMPOUND.....	14
VINYL CONDITIONER.....	6
VINYL DRESSING.....	6
WATERLESS HAND CLEANER.....	10,11
WAX APPLICATORS.....	7
WAXES.....	7,8,16
WD40.....	22
WEATHERSTRIP ADHESIVE.....	14,30
WHEEL BEARING GREASE.....	23,24
WHEEL CLEANER.....	4,12
WHEEL PROTECTANT.....	12
WHEEL RESTORATION KIT.....	12
WHITE LITHIUM GREASE.....	2,18,24,35
WHITewALL CLEANER.....	4
WINDOW WELD SEALER.....	32
WINDSHIELD ANTI-FREEZE.....	19,23
WINDSHIELD REPAIR KIT.....	16
WIRE WHEEL CLEANER.....	4,12
WOODGRAIN REMOVER.....	34

CHEMICALS

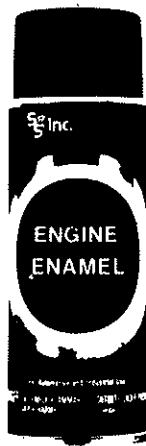

S&S AEROSOL PAINTS

S&S spray paints are specially formulated to satisfy the many conditions which must be met in repair and maintenance usage. OEM designated colors are an exact match to original. 12/case

- FAST DRYING
- NON RUNNING
- SAVES TIME
- HIGH SOLIDS CONTENT
- HEAT RESISTANT TO 500°
- WILL NOT CHIP OR FLAKE
- PROFESSIONAL 16 oz. CANS
- HIGH GLOSS SUPERIOR LEVEL OF DURABILITY

T99100 DULL ALUMINUM	T99109 RED PRIMER
T99101 FLAT BLACK	T99110 COM ED BEIGE
T99102 FLAT WHITE	T99150 BLACK ENGINE
T99103 GLOSS BLACK	T99151 FORD/CHRYSLER RED ENGINE
T99104 GLOSS WHITE	T99152 FORD/BLUE ENGINE
T99105 GRAY PRIMER	T99153 CHRYSLER BLUE ENGINE
T99106 CLEAR ACRYLIC	T99154 GM BLUE ENGINE
T99107 BRIGHT ALUMINUM	T99155 CHEV MOLY-ORANGE ENGINE
T99108 SATIN BLACK	



T99200 SILICONE SPRAY

A superior silicone lubricant formulated for the professional user-with extension tube for hard-to-reach applications.

- EXCELLENT LUBRICATION AND WEAR REDUCTION
- USE ON METAL, RUBBER AND WOOD
- ODORLESS, NON STAINING
- FORMS A SILICONE BARRIER TO PROTECT AGAINST MOISTURE SEEPAGE
- GOOD FROM -35°F TO +325°F
- CORROSION PROOFS PROTECTED SURFACES

T99200 16 oz. spray can 12/cs.



T99201 CARB & CHOKE CLEANER

Proven top quality formulation and special aerosol valving makes this the best professional carb and choke cleaner ever offered. Removes gum, varnish and carbon deposits easily and quickly. Comes with extension tube for hard-to-reach applications. The professional's "spray-aid" for:

- CARBURETORS
- PCV & POLLUTION CONTROLS
- EXCELLENT METAL CLEANER
- MANIFOLD HEAT CONTROLS
- AUTOMATIC CHOKES

T99201 16 oz. spray can 12/cs.

CHEMICALS



T99202 BRAKE CLEANER

A completely safe, economical and effective cleaner. Ideal for servicing brake systems by removing fluid residues and other contaminants. Can be quickly flushed away—leaves no greasy film.

- NON-FLAMMABLE, NO FLASHBACK
- HELPS ELIMINATE BRAKE SQUEAL
- USE ON LINING—DRUMS, PADS, CYLS

T99202 20 oz. spray can 12/cs.



T99203 PEN-PRO LUBRICANT

A versatile penetrating and protecting lubricant. Special formulation makes this a must for every mechanic and maintenance man.

- PENETRATES
- DRIES WET IGNITION AND ELECTRICAL PARTS
- HARMLESS TO RUBBER, PLASTIC, PAINTED PARTS
- LUBRICATES
- PREVENTS RUST
- STOPS SQUEAKS

T99203 16 oz. spray can 12/cs.



T99204 LITHIUM WHITE GREASE

An all purpose lithium grease that repels moisture. Excellent for outdoor as well as indoor uses. Environmentally safe in all known applications. High lubricity excellent corrosion protection. Used for:

- CARS, TRUCKS
- BOATS
- FARM EQUIPMENT
- HOUSEHOLD APPLIANCES

T99204 16 oz. spray can 12/cs.

CHEMICALS



T99209 RED GREASE

Sprays as a pressurized liquid. Cures into a thick grease. Perfect for greasing those hard to get places that an ordinary grease gun can't reach. Penetrates before curing. For most any anti-friction application.

- RESISTS HEAT
- RESISTS WATER
- RESISTS PRESSURE
- RESISTS CHEMICALS

T99209 16 oz. spray can 12/cs.



T99210 RUBBERIZED UNDERCOAT

Excellent adhesion contains rubber compound for flexibility. Perfect for spot undercoating, repaired areas and as a sound deadener where needed.

- DRIES QUICKLY
- PREVENTS CORROSION

T99210 20 oz. spray can 12/cs.



T99215 ELECTRIC MOTOR CLEANER

The fast, easy way to clean electrical systems and equipment. Dissolves and flushes away grease, oil, dirt and leaves no residue.

- FAST
- THOROUGH
- ELIMINATES DISMANTLING OF MOST ELECTRICAL EQUIPMENT

T99215 16 oz. spray can 12/cs.



T99207 GLASS CLEANER

Tough, effective but safe cleaner. Cuts through built-up grime, residue and protective coatings. Will not leave streaks or distort light. Excellent cleaner for:

- GLASS
- PORCELAIN
- STAINLESS STEEL

T99207 20 oz. spray can 12/cs.

CHEMICALS

GLASS CLEANER

Leaving glass sparkling clean and beautifully clear without smudges or streaks. Super strong formula cuts through dirt and film . . . making professional window cleaning faster and easier.

UPRO-3932 32 oz. 6/cs.
UPRO-3901 1 gal. 4/cs.

UPRO-3905 5 gal. Drum
UPRO-3915 15 gal. Drum
UPRO 3955 55 gal. Drum

Quart

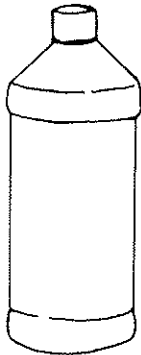

1 Gallon

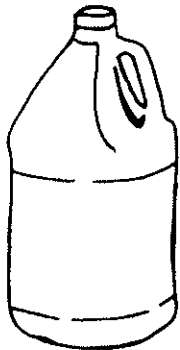

5 Gallon Pail

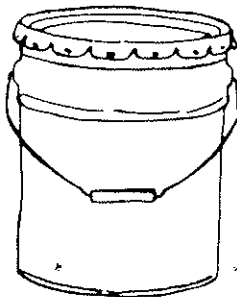

15 Gallon Drum

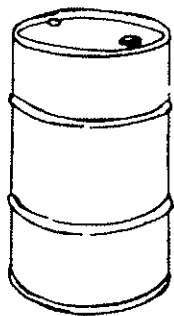

55 Gallon Drum

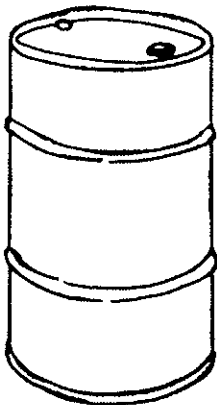

CONCENTRATE GLASS CLEANER

Industrial strength glass cleaner with excellent wetting properties will not leave water spots. Quickly and easily removes all grease, grime and film from glass. Dilute 1 part concentrated glass cleaner to 9 parts water. Using mist sprayer, apply to glass and wipe dry with lint free cloth.

UPRO-4001 1 gal.
UPRO-4015 15 gal.

UPRO-4005 5 gal.

WHITWALL TIRE CLEANER

Gives "whiter than ever" results in under 30 seconds. Good for cleaning the whole tire as it lifts the brownish color out of black rubber.

UPRO-2301 1 gal. 4/cs.
UPRO-2305 5 gal. Drum

UPRO-2315 15 gal. Drum
UPRO-2355 55 gal. Drum

WIRE WHEEL CLEANER

A one-step formula that quickly and easily dissolves rust, disc brake pad dust, grease, and road film without scrubbing or hand polishing.

UPRO-2632 32 oz. 6/cs.

UPRO-2601 1 gal. Drum
UPRO 2605 5 gal. Drum

TUFF-STUFF

Wire Wheel Cleaner

This concentrated cleaner may be diluted with two to twenty parts of water, depending on the condition of the surface to be cleaned. Brush or spray solution on surface to be cleaned, working from the bottom up. Allow to remain for three to five minutes and rinse thoroughly. Use plastic pails for making up solution. Do not allow this product to come in contact with glass, or painted surfaces. Do not use on hot surfaces. Always dispose of remainder of solution when cleaning job is finished.

THIS PRODUCT IS TO BE USED BY PROFESSIONAL AND TRAINED PERSONNEL.

UPRO-2732 quart
UPRO-2705 5 gal.

UPRO-2701 gal.

TIRE DRESS

Cleans and renews tires, rubber floor mats, pedals, door and window trim, weather stripping and bumper moldings. Keeps all exposed rubber looking like new while preventing drying and cracking.

UPRO-3701 1 gal. 4/cs.
UPRO-3705 5 gal. Drum

UPRO-3715 15 gal. Drum

NEW FORMULA: Higher gloss and longer lasting than the original formula.

UPRO-3701A .1 gal. 4/cs.
UPRO-3705A 5 gal. Drum

UPRO-3715A 15 gal. Drum

ENGINE SHAMPOO

Can be used on hot and warm engines. Its non-flammable formula contains special wetting agents that leaves engine compartments film-free and ready to paint.

UPRO-2501 1 gal. 4/cs.
UPRO-2505 5 gal. Drum

UPRO-2515 15 gal. Drum
UPRO-2555 55 gal. Drum

CHEMICALS

MOTOR SOL

Quickly and effectively degreases engines, parts, tools and machinery. Penetrates grease and/or oil on contact with no clinging after odor. Can be used on hot or cold engines as well as garage floors and other surfaces.

UPRO-2401 1 gal. 4/cs.
UPRO-2405 5 gal. Drum

UPRO-2415 15 gal. Drum
UPRO-2455 55 gal. Drum

BODY PREP

Removes grease, spots and stains from upholstery and vinyl—adhesives, sealers and rubber cement from vinyls-wax, tar, silicones, undercoating overspray and gum from hard surfaces. Safe for all finishes and leaves a "new car" smell.

UPRO-2032 32 oz. 6/cs.
UPRO-2001 1 gal. 4/cs.
UPRO-2005 5 gal. Drum

UPRO-2015 15 gal. Drum
UPRO-2055 55 gal. Drum

BIO-SOLVE CONCENTRATE

This multi-purpose degreaser concentrate removes tar, grease, oil, adhesive residue, waxes, cosmoline, and rustproofing. It's citrus based solvency easily "lifts" a wide range of stubborn spots and stains such as chewing gum, crayon, fresh paint, blood, ink and cosmetics. Used properly, Bio-Solve Concentrate has proven to be effective on nearly all surfaces including automotive finishes, carpeting, upholstery, concrete floors and walls.

UPRO-4301 1 gal. **UPRO-4305** 5 gal.

UPRO 4315 15 gal. Drum
UPRO 4355 55 gal. Drum

BIO-KLEEN

This Biodegradable Concentrate penetrates soils quickly and thoroughly, separates stubborn, deep-down dirt from the surface and holds it in suspension until it's ready to be wiped or rinsed away. Bio-Kleen is a non-caustic, non-flammable, non-carcinogenic formula that contains no harmful alkalies, acids, bleaches or toxics.

UPRO-4401 1 gal. **UPRO-4405** 5 gal.

UPRO 4415 15 gal. Drum
UPRO 4455 55 gal. Drum

INTERIOR DEODORANT

Completely eliminates all airborne odors after the source has been removed. Contains a time tested odor killer that neutralizes and destroys all offensive odors. Spray under front seat of the car. Available in 4 pleasant fragrances.

SMOKE AWAY:
UPRO-5516 pint
UPRO-5532 quart

FRESH AIR:
UPRO-5616 pint
UPRO-5632 quart

NEW CAR:
UPRO-5716 pint
UPRO-5732 quart

CINNAMON:
UPRO-5816 pint
UPRO-5832 quart

STAIN REMOVER

Removes industrial contaminants and acid rain spots from automobile finishes caused by industrial airborne particles, nitric oxide emissions and acid rain deposits. Spray stain remover full strength on all flat surfaces and allow to react for 10 minutes.

UPRO-4532 quart
UPRO-4505 5 gal.

UPRO-4501 gal.

SIMPLE GREEN

Simple Green may be used full strength for tough jobs, or diluted for specialized cleaning. It removes grease, grime, and dirt from automobile engines, tools, carpeting, upholstery, vinyl, concrete, even hands. Its revolutionary formula is biodegradable, non-toxic and non-abrasive.

U13005 1 gal. 4/case
U13006 5 gal. Drum

U13008 55 gal. Drum
U13013 32 oz. 6/case

U13016 5½ lb. can

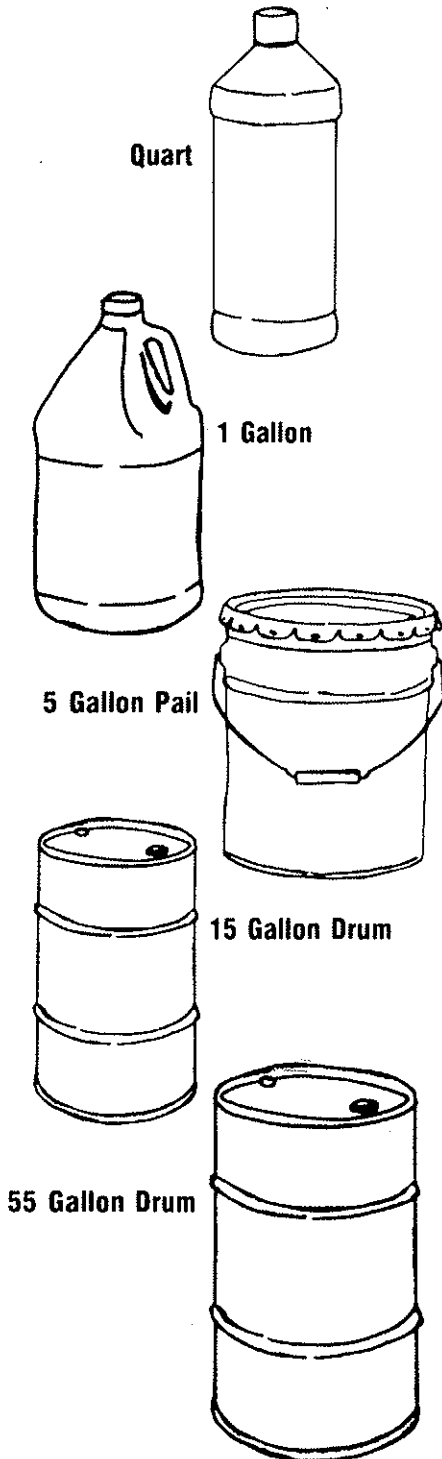

CHEMICALS

FAST CUT

Replaces ordinary rubbing compound for body shop paint work. Very effective with new acrylic lacquers, it spreads over large areas to cut new paint rub-out time by 50%. It also removes water spots common in new acrylic lacquer. Machine application only.

UPRO-3501 1 gal. 4/cs.

FAST CUT II

Fast Cut II is a new development designed to replace the common compound in the rubbing out operation of body shop paint work. It is exceptionally effective on new acrylic lacquers. The normal new paint rubbing out time is reduced by 50% and it leaves a smoother, highly lustrous, swirl-free showroom finish. Fast Cut II has a scientifically controlled action, thereby permitting its use on larger areas than is possible with common compounds. It is ideal for use in removing water spots commonly found on acrylic laquer finishes.

UPRO 6532 Quart 6/case

UPRO 6501 Gallon 4/case

SWIRL MARK REMOVER

Ideal for all automotive finishes. Easy to apply. Swirl Mark Remover removes scratches and oxidation with a minimum of effort. Quickly buffs to a beautiful bone-dry lustre with no messy throwoff. Will not swirl or smear black or glamour colors. Contains no harsh abrasives...wax and silicone free.

UPRO-3232 32 oz. 6/cs.

UPRO-3201 1 gal. 4/cs.

SWIRL MARK REMOVER II

Ideal for all automotive finishes. Easy to apply, removes mild scratches and oxidation with a minimum of effort. Quickly buffs to a beautiful bone dry lustre with no messy throwoff. Will not swirl or smear black or glamour colors. Contains no harsh abrasives...Swirl Mark Remover II is specially formulated for todays base coat/clear coat finishes.

UPRO 6232 Quart 6/case

UPRO 6201 Gallon 4/case

VINYL DRESS

Vinyl Dress is a poly base conditioner and does not contain paint or wax. The protective coating of Vinyl Dress will not fade, yellow, chip or peel. Following extensive laboratory testing and field trials, this formula has been verified as enriching and renewing the color depth of all vinyl materials.

UPRO-3832 32 oz. 6/cs.

VINYL CONDITIONER

Not an ordinary surface wax or cleaner, but a deep penetrating specially formulated conditioner that restores and protects leather, vinyl, plastic, rubber and formica. This advanced space-age formula protects against ozone, ultra-violet rays and oxygen that can crack, discolor, dull, harden or rot these materials. Leaves surface antistatic to repel dust and dirt and preserves their natural beauty, luster and softness. Safe and easy to apply, non-flammable, non-toxic, non-corrosive and odorless.

UPRO-5332 32 oz.

VINYL & UPHOLSTERY CLEANER

Leaves interiors with a cinnamon scent. For vinyl and hard surface cleaning and interior shampooing.

UPRO-2201 1 gal. 4/cs.

UPRO-2205 5 gal. Drum

UPRO-2215 15 gal. Drum

UPRO-2255 55 gal. Drum

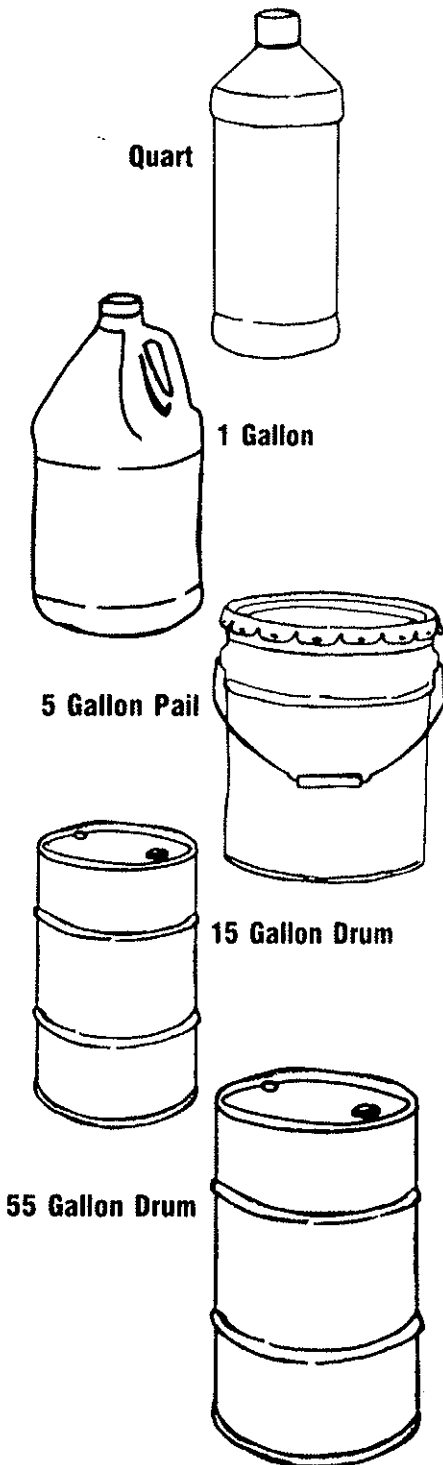

CHEMICALS

COSMOLINE EMULSION

Solvent degreaser with petroleum solvents. Will not harm paint. Water soluble for rinsing. Good for washing off grease coating applied to new cars. Safe to skin.

UPRO-4105 5 gal.

UPRO-4155 55 gal.

CAR WASH LIQUID

Reduces water's surface tension over 65% to make washing quicker and easier than ever. Super "wetting" formula strips off dust and dirt without affecting wax—even after repeated washings. Very good for automatic car washes.

UPRO-2101 1 gal. 4/cs.

UPRO-2115 15 gal. Drum

UPRO-2105 5 gal. Drum

UPRO-2155 55 gal. Drum

HI SUDS

HI SUDS is a specially formulated Hi Sudsing soap created for use where water conditions hamper the suds of typical car wash liquids. HI SUDS is an effective, economical concentrate that allows dirt and road grime to rinse off easily without streaking.

UPRO-2801 1 gal.

UPRO-2815 15 gal.

UPRO-2805 5 gal.

UPRO-2855 55 gal.

WAX APPLICATION PADS

For ease of application on any wax product.

UPROPAD (Foam)

UPROAP1 (Cloth)

SPRAY WAX

Fast and Easy. Ideal for all auto finishes, both domestic and imported, as well as fiberglass and chrome trim. Removes soil, dust and light oxidation.

UPRO-5232 32 oz.

UPRO-5201 1 gal.

SPRAY GLAZE II

Easy to use one-step cleaner and wax, using space age chemicals to achieve a deep showroom shine. Very fast to apply and wipe off. Especially handy when touching up showroom cars where fingerprints, handprints, and dust are visible on finish. Great for chrome and other bright metal trim.

UPRO 6032 Quart 6/case

UPRO 6001 Gallon 4/case

CARNAUBA WAX

Excellent for all lacquer, enamel, acrylic and luctite finishes. Fills in unsightly scratches and removes swirl marks as it coats the car with a smooth, glass-like finish. Will not rain-spot or wash off with soap and water. Can be applied in the sun or in the shade.

UPRO-5116 14 oz. can

UPRO-5105 5 lb. pail

FINAL FINISH WAX

A final finish paste wax that gives a brilliant wet look shine. Specifically formulated for show cars and those demanding the most brilliant finish. Excellent results with orbital polisher or by hand.

U4016 16 oz.

U4032 32 oz.

U4001 1 gal.

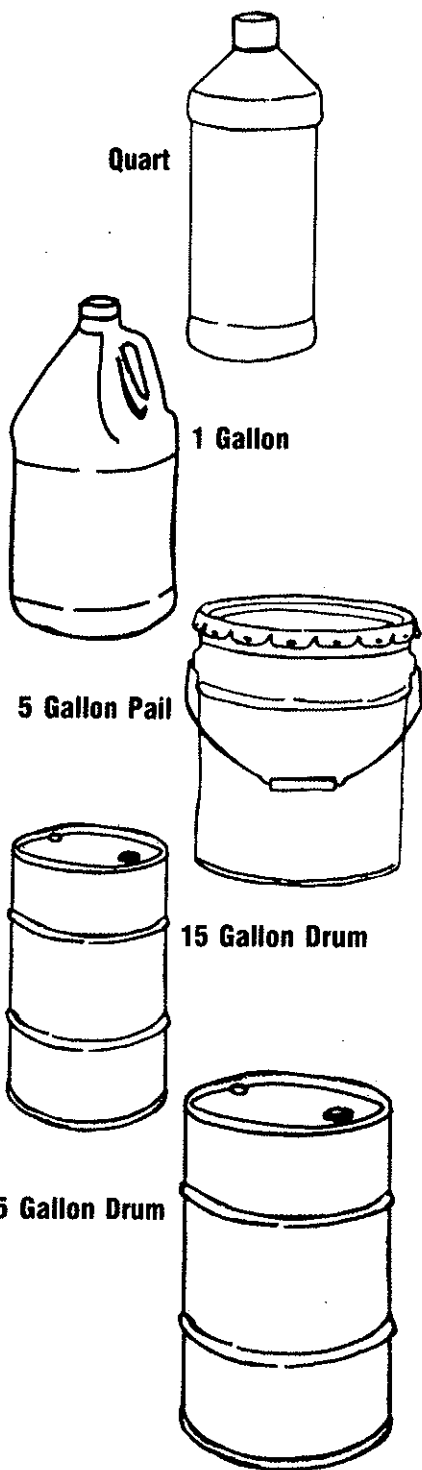

CHEMICALS

FINISH GLAZE

The synthetic wax discovery-Finish Glaze-produces one of the hardest and most desirable coatings chemically created. Finish Glaze has a mild cleaning characteristic that picks up residue from pre-cleaners. With this special formulation, Finish Glaze absorbs ultra-violet light, enhances depth of color and brilliance on darker surfaces and with a refined process, brings out the brightness of lighter finishes...giving maximum light refraction to all colors.

UPRO-3132 32 oz. 6/cs.

QUICK GLOSS

An outstanding cleaner and wax designed through space age chemicals for preparation of a new car for customer delivery. It imparts a deep showroom shine to the finish in one easy step. Excellent for hiding scratches and imperfections. Offers good durability and is not affected by car wash detergent.

UPRO-3632 32 oz. 6/cs.

UPRO-3601 1 gal. 4/cs.

BUFF N' GLAZE

Buff N' Glaze is a blend of fine waxes, mild cleaning agents and penetrating agents to condition and seal all acrylic, enamel and lacquer paint finishes. Especially effective on metallics, blacks, reds and other dark colors.

UPRO-3332 32 oz. 6/cs.

UPRO-3301 1 gal. 4/cs.

BUFF N GLAZE II

Buff N Glaze II is a blend of fine waxes, mild cleaning agents and penetrating agents to condition and seal all acrylic, enamel and lacquer paint finishes. Especially effective on metallics, blacks, reds and other dark colors. Buff N Glaze II can be used on new and used finishes, however, it was designed for today's base coat/clear coat finishes. It can be used as a one step cleaner and wax product with carnauba wax protection.

UPRO 6332 Quart 6/case

UPRO 6301 Gallon 4/case

CLEAR COAT COMPOUND

A high grade buffing compound formulated for use on clear coat finishes. It is designed to remove heavy oxidation, fallout marks, etching and deep scratches. Clear Coat is formulated to stay wet on surface thus reducing heat and the chance of burning the paint.

UPRO 6732 Quart 6/case

UPRO 6701 Gallon 4/case

BUFFING COMPOUND

Buffing Compound is a heavy duty liquid cleaning compound with a molecular action formula for total cleaning without surface damage. It leaves car exteriors with a smooth, highly lustrous finish. No mixing necessary.

UPRO-3501A 1 gal. 4/cs.

FINISH RUB

Cuts exterior clean-up time in half while removing oxidation, orange peel and overspray from factory finishes. Its exclusive cutting formula uses molecular action for complete cleaning without surface damage. Won't load the buffing pad like many other products, yet leaves a smooth, high-gloss surface with no mess. Machine application only.

UPRO-3401 1 gal. 4/cs.

NEUTRASEAL

Neutralizes acidic deposits trapped in the pores of the paint. Neutralseal contains a polymer sealer that protects against industrial fall out and acid rain contamination, leaves a high gloss lustrous shine on pre-cleaned surfaces. Neutralseal also protects chrome and all hard metal surfaces.

UPRO-4632 quart

UPRO-4601 gal.

UPRO-4605 5 gal.

Quart

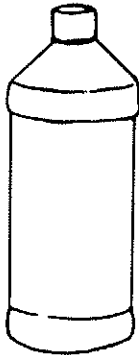

1 Gallon

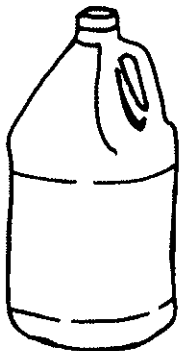

5 Gallon Pail

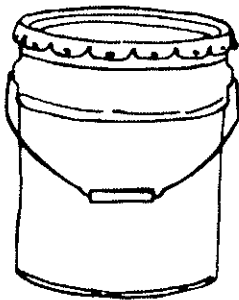

15 Gallon Drum

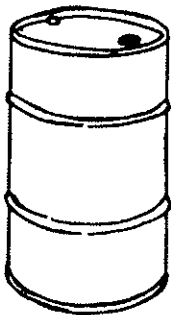

55 Gallon Drum

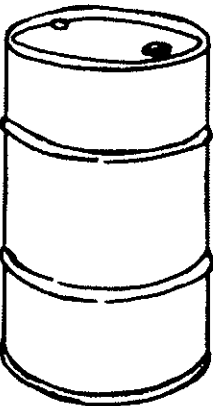

CHEMICALS

FALL OUT RUB

Formulated for use on today's clear coat finishes. Fall Out Rub is designed to remove etching from acid rain, industrial contaminants, water spots, oxidation and other major paint problems. Fall Out Rub penetrates into paint film to eliminate problem areas and leaves a smooth surface.

UPRO-4732 32 oz.

ENGINE GLAZE

A clear protective coating that seals and waterproofs engine compartments. Will not chip, crack, or peel with age. Surface should be thoroughly dry and free of rust, grease and dirt. Spray in well ventilated area. Hold 10-12 inches from surface.

UPRO-5901 1 gal.

CONCRETE CLEANER/FLOOR SOAP

Inexpensive, easy-to-use, whitens as it cleans by lifting grease, oil and dirt. Dissolves dirt and floats it to the surface without hard scrubbing. Dries lighter and gets rid of slippery, unsafe surfaces. Use in garages, service stations, factories, driveways—on any concrete surface. A little does a lot. Can be used to clean battery terminals or chassis, steel and iron parts, even on aluminum in a solution.

UPRO100PFC 100 lb.

POWDERED LAUNDRY DETERGENT

Cuts through grease and grime on shop towels, uniforms and other washables.

PRO100LD 100 lb Drum

SOLVOX Car Wash

Safety cleaner for all exterior & interior surfaces. Solvox Car Wash is a well inhibited powdered cleaning material. For use in mechanical brush washer machines, automatic spray equipment and hand (manual) cleaning.

SOLVOX Car Wash has superior wetting out and rinsing qualities, effective at lower concentrations on ordinary surface dirt, with good penetrating action on oxidized films.

Safe on painted, lacquered, varnished and stainless steel surfaces in hot or cold weather. Excellent solubility, long solution life, easy to use, good window cleaning solution, brings out luster to surfaces.

U80LB 80 lb. Drum

MINERAL SPIRITS SOLVENT

Oil soluble product used in the removal of heavy oils and greases.

U54055 55 Gallon

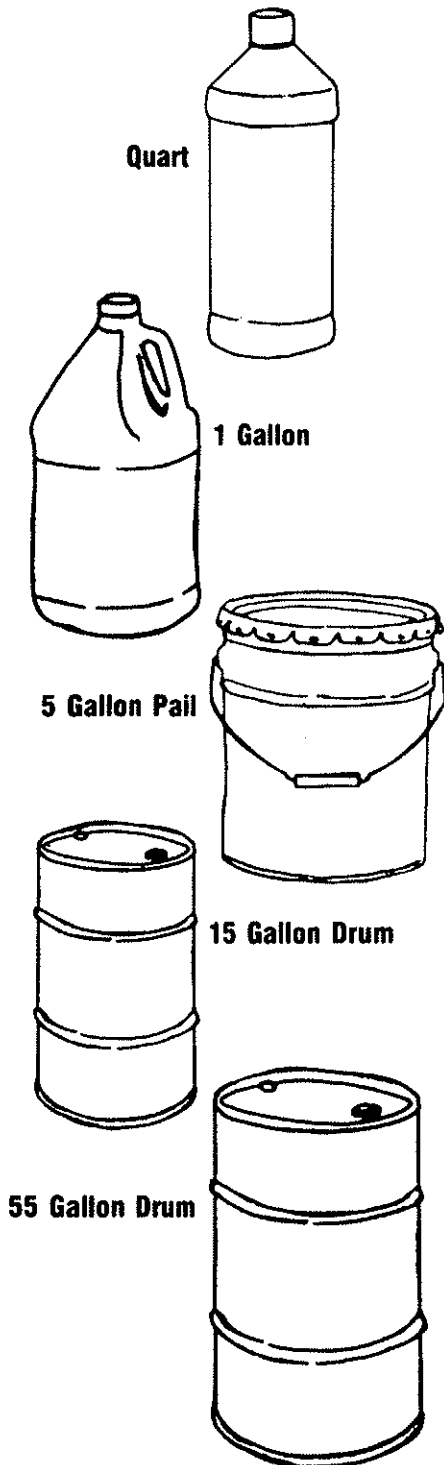

CHEMICALS



This revolutionary Go-Jo Heavy Duty Hand Soap not only works great on cleaning greasy, grimy hands- it smells great too. A specially developed filtration process eliminates objectionable odors. And the new fresh scent formula contains pure lanolin, so it also conditions hands.

T1181G 12/cs.



Go-Jo Hand Cleaner. 18 oz. of Go-Jo in resealable, portable can ideal for tool boxes, service truck, work area and home.

T1109G 12/cs.



Go-Jo with fine Italian Pumice. 20 oz. Easy dip out, resealable plastic can.

T1132G 12/cs.



Go-Jo Extra Heavy Duty Hand Cleaner 4½ lb. can of Go-Jo Hand cleaner fits Go-Jo #1200 heavy duty wall dispenser.

T1111G 6/cs.



T1135G



T1115G 6/cs.

Go-Jo Hand Cleaner 4½ lb. Go-Jo Hand Cleaner Cartridge fits #T1204G wall mounted Dispenser.

GO-JO DISPENSERS

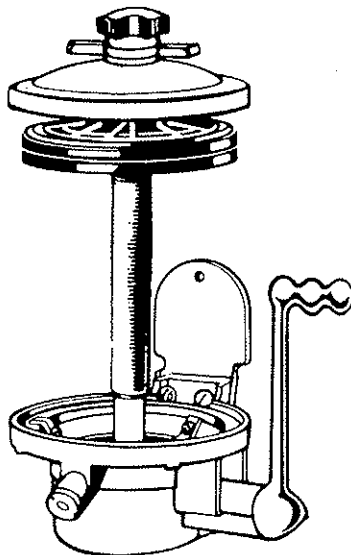

Go-Jo Heavy Duty Wall Mounted Dispenser. Built for the most rugged application. Use with stock T1111G, 4½ lb. Go-Jo Hand Cleaner disposable cartridge.

T1200G

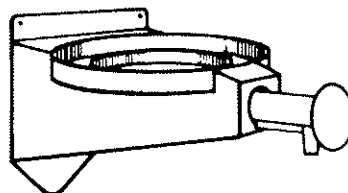

Go-Jo Heavy Duty Dispenser. Use with T1115G, 4½ lb. Go-Jo Hand Cleaner.

T1204G

Pumice Cartridge Dispenser
T1235G



CHEMICALS



WEPAK HAND CLEANER

Pink liquid hand cleaner with a fresh fragrance suds and softens the hands while it cleans and removes dirt in cold or hot, soft or hard water.

TPHL 1 Gallon



DL Blue Hand Cleaner

Leaves hands both clean and pleasant smelling. Invaluable to car mechanics, painters, do-it-yourselfers or any one with dirty hands.

- T01013** 1 lb. can 12/cs.
T01556 5 1/2 lb. can 6/cs.

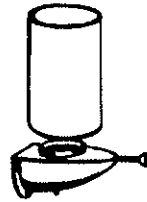

DL Soap Dispenser

The hand cleaner dispenser that stood the test of time. Proven durable and able to take the toughest punishment. Easy to install, this unit is guaranteed for 5 full years.

- T90902** 4 1/2 lb. can
T90126 pump



DL Trounce

Now there's a solution to really dirty hands. Use it for grease, paint, glue, resins, printer's ink, plastics, rubber and tile cements, and tough cleaning products.

- T21116** pint 12/cs.
T21218 gal 4/cs.



ANCO Hand Cleanser

The best way to remove oil, grease, paint, ink and gasoline odor.

- T85002** 2 lb. box
T85005 5 lb. box
T85025 25 lb. can



TROUNCE Pumice Hand Cleaner with lanolin and aloe

14oz. pumptainer TDL21114



Pink Thick Bowl & Porcelain Cleaner

Magically magnetized formula to cling to any vertical bowl or porcelain surface. Thick, mild and pleasantly scented.

TPMBC32 1 quart 12/case



Fast Orange Natural Citrus Hand Cleaner with aloe, lanolin and jojoba

- Pumice Formula**
 7.5oz TDL25108
 14oz. pumptainer TDL25114



White Emulsion Bowl Cleaner

Concentrated to clean, de-scale and deodorize toilet bowls and urinals quickly and thoroughly with minimum effort.

TWBC32 1 quart 12/case

CHEMICALS



PRIORITY ONE Pro-Max Non Acid-Non Caustic Wheel Cleaner

Safe on all wheels. Effectively cleans brake dust off wheel surfaces. Will not damage clear coated, painted, anodized, or highly polished aluminum wheels.

- U33036** 12 oz. pump
- U33037** 22 oz. trigger
- U10036** 1 gallon



PRIORITY ONE Mag/Chrome Polish & Protectant

Polishes aluminum to a mirror-like finish. Blended with anti-oxidant and sun-screen. Will not scratch aluminum. Polishes gold, silver, brass and copper.

- U33029** 12 oz. bottle

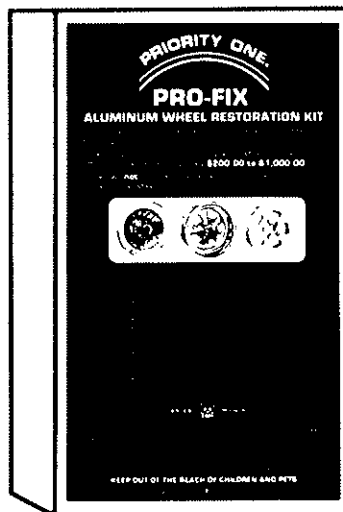

PRIORITY ONE Aluminum Wheel Restoration Kit

Restores the original luster to all aluminum wheels. Kit Includes:

- Aluminum Polish
- Clear Coat & Paint Stripper
- Mag Wheel Cleaner
- Detail Brush
- Horsehair Polishing Wheel (to be used with 1/4 to 1/2 power drill not included in kit)
- Abrasive Pad
- Ultra Fine Sand Paper
- Tool to polish around decorative rivets
- Complete information and instruction guide with photos

- U33023** 3.7 lbs



PRIORITY ONE Custom Wheel Protectant

Protects clear coated wheel finish. Use on all factory and custom wheels. Chemically bonds itself to surface. Locks out atmospheric conditions. Regular use eliminates build-up of brake dust.

- U33039** 12 oz. pump

CHEMICALS



PERMATEX Black RTV Silicone Adhesive Sealant

Shields and insulates wind shields, lights, body and cab panels. Protects and repairs electrical wiring. Repairs worn rubber parts. Bonds glass, metal, plastics, fabric, vinyl, weatherstripping and vinyl tops.

- T16B** 3 oz. tube 12/cs.
T16C 11 oz. cartridge 10/cs.



PERMATEX No. 1 Form-A-Gasket

A fast drying, hard setting, heavy bodied sealant ideal for permanent assemblies, filling in uneven surfaces, repairing gaskets, fittings, threaded connections and cracked batteries.

- T1B** 3 oz. tube 36/cs.
T1C 13 oz. tube 12/cs.



PERMATEX No. 2 Form-A-Gasket

Non-hardening, heavy bodied pliable sealant for semi-permanent assemblies. Use on cover plates, flanges, threaded assemblies and hose connections.

- T2B** 3 oz. tube 36/cs.
T2C 11 oz. tube 12/cs.



PERMATEX Silicone Form-A-Gasket

Blue. Actually makes any size, any shape gasket in minutes. The finest all-purpose sealant made. Seal remains flexible.

- T6C** 11 oz. cartridge 12/cs.
T6BR 3 oz. tube 12/cs.
T6M 12 oz. tube 12/cs.
T6MA 8 oz. aerosol 12/cs.
T6PC 6oz. power cartridge 10/cs.

PERMATEX Hi-Temp Silicone Form-A-Gasket Sealant

Replaces almost any cut gasket. Specially designed for high temperature gasketing applications. Resists cracking, shrinking and migrating caused by thermal cycling. Dries tough and flexible.

- T26B** 11 oz. cartridge 12/cs.
T26LA 4½ oz. aerosol 12/cs.
T26PC 6 oz. power cartridge 10/cs.

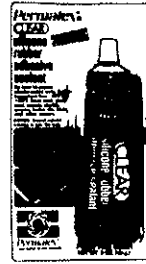

PERMATEX Silicone Rubber Adhesive

Clear. Seals or replaces a wide range of gaskets. makes any size, any shape gasket in minutes and eliminates delays due to out-of-stocks or incorrect gasket sizes.

- T66BR** 3 oz. tube 12/cs.
T66C 11 oz. cartridge 12/cs.
T66LA 4.6 oz. aerosol 12/cs.
T66PC 6 oz. power cartridge 10/cs.



PERMATEX Low Volatile Silicone Form-A-Gasket

Specially formulated to meet the volatility specifications for oxygen-sensor equipped General Motors engines. GM specified "low volatile" silicone. high temperature feature to 650°F, intermittent exposure only.

- T27BR** 3 oz. tube 12/cs.

PERMATEX Ultra Blue RTV Silicone Gasket

Three times more oil resistant than other silicones. . . Two times stronger between oily surfaces than other silicones. . . Eight times more flexible than cork/composite gaskets.

- T77BR** 3.35 oz. 12/cs.
T77C 13 oz. 12/cs.
T77LA 5½ oz. aerosol 12/cs.
T77PC 6 oz. power cartridge 10/cs.

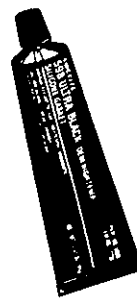

LOCTITE Ultra Black Silicone Gasket

Once cured, Loctite Ultra Black actually swells slightly on contact with hot engine oil to increase the sealing area, preventing leaks. OEM specified gasket material.

- T598B** 3.35 oz. tube 12/cs.

PERMATEX Aviation Form-A-Gasket

A non-hardening, liquid brushable sealant. Seals close-fitting parts, water pumps, coolant and heating hose connections, threaded assemblies.

- T3D** 1 pint 12/cs.
T3H ¼ pint 12/cs.



CHEMICALS



PERMATEX Gasket Remover

Quickly removes baked-on gasket sealants and adhesives. Works on silicone, weatherstrip adhesive, carbon deposits, dried oil, grease and paint.

T4MA 12 oz. spray 12/cs.

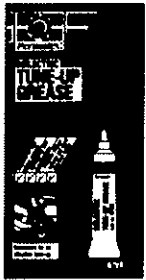

PERMATEX Hylomar Gasket Dressing Sealant

Uniquely formulated gel that allows for sealing for flanges with or without a gasket. This products ability to withstand vibration makes it ideal for use on threaded fittings.

T81997 1 1/2 oz. tube 12/cs.



PERMATEX High Tack Adhesive Sealant

Holds gaskets in place during assembly. Assures proper gasket position and alignment. Seals hose connections. Dries fast to a highly tacky film.

T99GA 6 oz. spray 12/cs.

T99MA 12 oz. spray 12/cs.



PERMATEX High Tack

Seals and bonds rubber, cork, felt, paper, metal or asbestos gaskets. Assures correct gasket alignment during assemblies.

T98D 1 pint 12/cs.

PERMATEX Copper Spray-A-Gasket

Seals metal and rubber gaskets in high temperature applications up to 450°F. Seals instantly. Remains pliable for easy gasket repositioning.

T101MA 12 oz. spray 12/cs.

T101BR 3 oz. tube 12/cs.

T101LA RTV aerosol 4 1/2 oz. 12/cs.

T101PC ATV 6 oz. power cartridge 10/cs



PERMATEX Super Weatherstrip Adhesive

Fast drying, exceptionally strong, completely waterproof. Flexible. Resistant to oil, grease and solvents.

T80L 5 oz. tube 12/cs.



PERMATEX Dielectric Tune Up Grease

Protects electrical connections and wiring from salt, dirt and corrosion. Extends the life of bulb sockets. Prevents downtime and saves money.

T67VR .33 oz. tube 12/cs.



PERMATEX Jack Oil

Prevents rust and stops sludge build-up in hydraulic jacks. Improves lubrication in all types of hydraulic units. Maintains proper viscosity & permits hydraulic actuating mechanisms to function properly at temperatures from -49° to 120°F.

T78F 1 gallon 4/cs.



PERMATEX Anti-Sieze

Prevents galling, seizing and corrosion of all types of metal parts from 65°F to 2,000°F. Protects metal joints from heat, steam or grease. Works on engine parts and equipment.

T133K 1/2 pt. brush-top can 12/cs.

T133MA 12 oz. aerosol 12/cs.



PERMATEX Valve Grinding Compound

Aids valve grinding and seating operations. Can be used for tapping and grinding chromium-cobalt hardfaced seats and discs. Mixes with water to form an easy-to-use paste. Three times more oil resistant than other silicones. . . Two times stronger between oily surfaces than other silicones. . . Eight times more flexible than cork/composite gaskets.

T34A 1.5 oz. tube 36/cs.



PERMATEX Carburetor and Parts Cleaner

Removes grease, gum, varnish, paint and barrel carbon from carburetor assemblies and all metal parts—works on all types of engines and equipment.

T46Y 3.5 gal. 1/cs.



PERMATEX Disc Brake Quiet

Provides a high temperature water resistant, protective film that dampens vibration and chatter, the cause of disc brake squeal.

T127MA 12 oz. spray 12/cs.

T126HB 4 oz. can 12/cs.

CHEMICALS



PERMATEX Electronic Parts Cleaner

Penetrates and cleans oil, dust, and dirt from surface pores without leaving a residue. Safe on paints, plastics and synthetics. This product effectively removes dust, lint and light oil from tape heads, tuners, sensitive equipment and contact points.

T201DA 12.75 aerosol 12/cs.



PERMATEX Ultra Slick Engine Assembly Lube

Proper lubrication of metal mating surfaces is essential prior to starting a new or rebuilt engine. Can be used on cam shafts and lifters, engine bearings, rocker arms, timing components, valves, guides and rocker shaft assemblies.

T81950 4 oz. bottle 12/cs.



PERMATEX Brake & Parts Cleaner

Penetrates, dissolves and removes dirt and oil. All purpose cleaner, parts primer, and gasketing surface prep. No perchloroethylene.

T123DA 2 oz. aerosol 12/cs.



MOTSEBOCKER Lift-Off

Lift-Off is three cleaners in one; gum and adhesive remover, automotive degreaser, and household spot remover.

T12448 5 oz. aerosol 12/cs.



PERMATEX Carb & Choke Cleaner

Super jet spray quickly cuts and removes grease, gum and varnish. Cleans manual and automatic chokes, baffle plates and carburetor linkage. Does not contain toluene, methylene chloride or methanol.

T137DA 16 oz. aerosol 12/cs.



LOCTITE Pipe Sealant with Teflon

Locks and seals threaded fittings against leakage and vibrations. Lubricates threads for easy assembly and disassembly.

T59214 6 ml. carded tube 12/cs.

T59231 50 ml. carded tube 12/cs.



LOCTITE Form-A-Thread Stripped Thread Repair

Eliminates the need for special tools, inserts, drills and taps. Easy to use. Repairs almost all fastener sizes and thread grades.

T81668 tool box size 6/cs.



LOCTITE 242 Threadlocker

Blue. Medium strength—eliminates need for lock washers and lock nuts. Locks and seals to prevent parts from loosening due to vibration.

T24200 6 ml. 12/cs.

T24240 36 ml. 3/cs.



LOCTITE 271 Threadlocker

Red. High strength—holds and seals slip and press fit assemblies. Replaces set screws and snap rings.

T27100 6 ml. 12/cs.

T27140 36 ml. 6/cs.

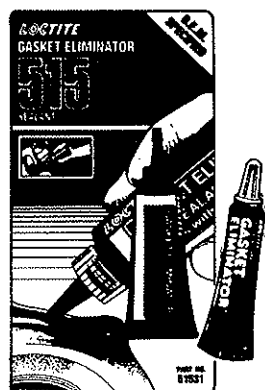

LOCTITE Gasket Eliminator

Makes any size, any shape gasket in minutes. Flexes with flanges that move in service. Allows metal-to-metal fit, eliminates bolt retorquing. Suitable for coating and repairing cut gaskets.

T51517 6 ml. carded tube 12/cs.

T51531 5 ml. carded tube 6/cs.

CHEMICALS

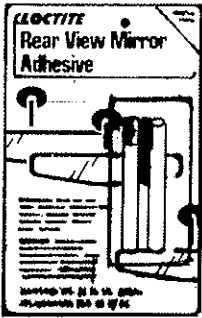

LOCTITE Mirror Adhesive

Remounts mirrors to windshields. Handling strength achieved in seconds. 60% full strength in minutes. Provides stronger than glass adhesive bond in only twenty-four hours. Pkg'd w/primer.

T110672 3 ml. carded tube 12/cs.

T3325 24 ml. bottle



PENRAY Super Weatherpruf Car Wax Paste

Paste kit type. A detergent resistant car wax that won't wash off in 50 or more washings! No buffing or hard rubbing—leaves a hard protective finish through the coldest and hottest temperatures.

T0250 14 oz. net wt. kit



LOCTITE Windshield Repair Kit

Complete, easy-to-use kit repairs stone damage, makes a crystal-clear repair and requires no mixing or special tools.

T16067 .17 fl. oz. syringe carded



LOCTITE Super Bonder

Ready-to-use one part adhesive bonds close fitting metal, plastic, glass, vinyl and rubber parts in seconds with strengths up to 5,000 psi.

T49450 1 oz. carded btl. 6/cs.

T49411 3 cc. carded tube 12/cs.



LOCTITE Form-A-Lens Automotive Lens Repair Kit

High-tech liquid resins actually rebuild broken taillights or signal lights. Seals out damaging moisture and road salt for a permanent, safe repair.

T81667 clear 6/cs.

T81767 amber 6/cs.

T81867 red 6/ca.



DURO Quick Gel Super Glue

Thick, no-run, instant adhesive. 150 times thicker than regular super glue. Bonds both porous and non-porous materials.

TSGGA 2g carded tube 12/cs.



LOCTITE Quick Grid Rear Window Defogger Repair Kit

Repairing damaged rear window defogger grid is a big problem for professional and do-it-yourselfer mechanics alike. . . and that means big business for you. Loctite Quick Grid Repair Kit is the first easy-to-use, professional quality repair product that solves this million dollar a year problem.

T15067 1.4 ml. btl. w/stencil 12/cs.



LOCTITE Fast Cure Epoxy

Seals and repairs plastic and metal parts in 15 minutes. Pre-measured cups.

T44581 10—4 gr. mixer cups

T44583 10—1 oz. mixer cups

DURO Super Glue Adhesive Remover

Quickly and safely removes all types of instant adhesives from most surfaces, including skin. Eliminates the need for nail polish remover, acetone, etc.

SGR1 .3 oz. 12/cs.



LOCTITE Loc-Weld Cold Bonding Compound

A fast-cure, two-part adhesive and filler that eliminates the need for welding or brazing. Once cured, it can be drilled, tapped, threaded or filed. Resists most automotive and shop fluids. Works on steel, iron, copper, aluminum, brass, bronze, castings and stampings.

T14600 2 oz. 12/cs.

CHEMICALS



PENRAY Gum Solve Liquid Carburetor Cleaner

Added to gasoline - removes gums and varnish from fuel lines. Removes lead, carbon and moisture giving better gas mileage. Improves pick-up and promotes better gas mileage.

T2012 16 oz. 30/cs.



PENRAY Gum Solve Spray Carburetor Cleaner

Tunes up entire inner engine "breathing" system. "The serviceman's spray aid" for internal and external cleaning of automatic chokes, carburetor linkage and manifold heat controls.

T2114P 13 oz. nt. wt. aerosol 18/cs.



PENRAY Pro-Line Gas Treatment

Designed for all gasoline engines, with emphasis on cleaning up and maintaining fuel systems. Absorbs moisture as an extra added benefit.

T3812 12 oz.



PENRAY Fuel Injection Cleaner

Helps keep injector spray patterns and system pressures as originally specified. Disperses moisture, provides upper cylinder lubrication.

T2112P 12 fl. oz.



PENRAY Motor Aid

Stops excessive oil burning. A concentrated treatment that extends motor life.

T3116 15 oz. 30/cs.



PENRAY Transmission Sealer And Conditioner

Stops and prevents leaks in power steering units and automatic transmissions caused by hard, dry seals. Restores chemical balance to transmission fluid. Improves valve operation for smoother, quieter shifting.

T3210 10 oz. tube 18/cs.



PENRAY Diesel Flo

Quick starts in sub-zero weather. Eliminates gelling of diesel fuel. For use in auto and truck equipment. Protects to -40°. Easy pour can.

T3716 16 oz. tube 24/cs.



PENRAY Diesel Fuel Conditioner

Recommended for all diesel engines. Keeps injectors clean, aids complete combustion. 100% combustible with fuel, does not affect cetane rating. Keeps fuel tanks, line and filters free of water, gum and wax.

T3512 12 oz. 24/cs.

T3532 30 oz. 24/cs.

CHEMICALS



PENRAY PR-3

"The Mechanic's Right Hand" penetrates, lubricates, starts wet engines, stops rust and corrosion; frees parts, stops squeaks. Harmless to rubber, plastics and painted surfaces.

T4516 13.3 oz. nt. wt. aerosol 18/cs.



PENRAY White Lithium Grease

A year-round all-weather grease for cars, trucks, boats, farm equipment and household accessories. Features high lubricity, corrosion protection, water and heat resistance.

T4816 13 oz. nt. wt. aerosol 18/cs.



PENRAY Wrench-Eze

Fast action concentrated solvents instantly frees frozen joints; loosens rust and corrosion from nuts, bolts, engine heads and metal parts.

T4012 12 fl. oz. spray 18/cs.



PENRAY Silicone Spray

Lubricates as well as reduces wear and squeaks of rubber weatherstripping on windows, doors, hoods, etc. Also prevents freezing and sticking of rubber parts.

T3416 13 oz. nt. wt. aerosol 18/cs.



PENRAY Engine Cleaner And Degreaser

Ready to use aerosol can. Just spray on...rinses off with water. Cleans car and truck engines, power mowers and garage floors.

T4220 16 oz. nt. wt. aerosol 18/cs.



PENRAY Rubberized Spray Undercoat

Rustproofs, deadens sound. Gives ideal protection against corrosion on fender sections, rocker panels, hood deck. Sprays on evenly—dries quickly. Contains rubber compound for flexibility.

T4424 20 oz. aerosol 18/cs.



PENRAY Power Steering Fluid

Meets new car manufacturers specifications for GM, Ford and AMC. It also protects against foaming, wear and slippage.

T3912 24/cs.



PENRAY Brake Fluid

For all drum and disc brakes. Equivalent to original-fill fluids used by GM, AMC and Chrysler. Minimum boiling point 410° F. Tamper-proof inner seal on all containers.

T6012 12 oz. 36/cs.

T6001B Gal.



PENRAY Brake Guard

Safely dissolves and removes brake fluid, oil, grease and other contaminants without disassembling brake or clutch assemblies.

T4720 19 oz. nt. wt. aerosol 18/cs.

CHEMICALS



PENRAY Starting Fluid

Just spray into air intake for fast, easy starting of all gasoline and diesel engines. Works to 65° below zero. Also provides upper cylinder lubrication.

T5315 30 cs.



PENRAY Nox-Ice Gas Line Anti-Freeze

A highly concentrated gasoline anti-freeze that ends gas line freeze-up. Mixes thoroughly with gasoline. Improves carburetion. Aids quick starting. Compatible with catalytic converter systems.

T5112 12 oz. 30/cs.



PENRAY Windshield Washer Anti-Freeze

An all-year-round concentrated solution that removes bugs, dirt and road film from windshields like magic. Not injurious to car finishes.

T5016 16 oz. 36/cs.



PENRAY Air Brake Anti-Freeze

Dryer and rust protector. Used in air brake system reservoir for complete winter protection. Absorbs moisture, protects form corrosion.

T5632 18/cs.



PENRAY Cooling System Conditioner

Removes rust, scale and corrosion. Prevents rust and keeps cooling system clean. Lubricates water pump bearings and seals. Increases heat transfer instead of insulating system. No draining or flushing.

T1012 11 oz. tube 30/cs.



PENRAY Cool Prep

Advanced formula designed to remove, dissolve or disperse scale, corrosion, silica gel, sludge and light oil contamination. Helps stop engine overheating, improves heat transfer and protects against scale and corrosion. Will not harm hoses, seals, gaskets and other system hardware.

T1232 32 fl. oz.



PENRAY Cooling System Sealer

Stops and prevents leaks and anti-freeze seepage. Especially effective in high compression engines. Can't clog small radiator and heater cores.

T1310 11 oz.



PENRAY Cool Tec 2

Eliminates corrosion, scale buildup and retards the formation of solder bloom. Improves heat transfer capabilities of coolant and protects all types of metal surfaces. Stabilizes anti-freeze by preventing silicate dropout.

T1112P 12 oz. 24/cs.

CHEMICALS



PENRAY Car Wash

Power detergent for manual washing of cars, trucks and buses. One-half ounce makes 4 gallons of fast, non-streak, self-drying washing solution. Completely safe on automotive finishes.

T0401 4 lb. can 6/cs.

T0420 20 lb. drum 1/cs.



PROTECTOR PLUS Oil Additive

The Oil Additive is a poly functional teflon combination in a Stoddard carrier. It reduces friction and helps to more evenly disperse engine lubrication heat. It increases oil adhesion for added surface protection, and helps prevent engine top-end lube starvation during start-up.

OPRO5500 8 oz.



PENRAY Glass & Utility Cleaner

Ideal for cleaning stainless steel, chrome, windshields and most plastic surfaces.

T4120 8.9 nt. wt. aerosol 30 cs.



PROTECTOR PLUS Injector Additive

Injector Plus is a high technology blend of saturated aliphatic hydrocarbons. It purges fuel lines to allow correct fuel flow, and helps to dislodge deposit build-ups on clogged injectors and reconditions injector surfaces. It also restores correct injector spray pattern, and helps to restore maximum engine performance.

OPRO 5504 12 oz.



PENRAY Tar Remover

A quick-acting solvent that quickly dissolves and removes tar and road oil from all finishes. Perfectly safe for painted surfaces.

T0312 8.9 nt. wt. aerosol 30/cs.



PROTECTOR PLUS Fuel Additive

The Fuel Additive helps to keep carburetors and fuel injection systems clean and at peak performance. It dislodges slug build-up and reduces the effects of water contamination.

OPRO5502 8 oz.



SUPER-XTM

T214X SPRAY CARBURETOR CLEANER Aerosol spray can equipped with snorkel tube. Spray into carburetor, air-intake. Cleans choke, linkage, anti-smog valve, heat riser, and related parts. Removes gum, varnish and carbon deposits. 16 oz. Aerosol Can.

T350X SILICONE SPRAY Effective from -35° F to 325° F. Lubricates and reduces wear of rubber weather-stripping on windows, doors, hoods; waterproofs electrical systems, prevents battery corrosion, is an excellent electrical insulator. Stops/prevents window sticking. 16 oz. Aerosol Can.

T620X ENGINE CLEANER AND DEGREASER Removes grease, sludge, dirt and tar from engine within minutes. Simply spray on and hose off. Also ideal for cleaning lawn mowers, marine engines, and motorcycles. 20 oz. Aerosol Can.

T630X BRAKE CLEANER Formulated for effective use with both drum and disc brake assemblies. Will safely dissolve and remove brake fluid along with oil and grease from brake clutch assemblies. Contains no carbon tetrachloride or silicones. No need to disassemble brake assembly for application. 20 oz. Aerosol Can.

T670X SUPER PENETRANT Super tool for car, home, shop, marine. Makes repair work easier whenever trouble is caused by rust, moisture, dirt or friction. Use to start wet engines, loosen frozen parts, protect metal, etc. Harmless to rubber, plastics and painted surfaces. 12 oz. Aerosol Can.

TSS360 ENGINE OIL SUPPLEMENT Specifically designed to improve performance of today's modern engines. 16 oz. Can

CHEMICALS



CRC 5-56

Penetrates deep through rust and corrosion. Eliminates need for any disassembly operations. Lubricates with long-lasting uniform film. Removes moisture, starts wet engines. Protects against rust and corrosion.

T5005C 12 oz. can 12/cs.

T5007C 1 gal. can 4/cs.



CRC Brakeleen

Spray brake systems really clean without disassembling. Makes brakes last longer and perform better.

T5089 20 oz. spray 12/cs.



CRC Disc Brake Quiet

Dampens the vibrations that cause disc brake noise. Eliminates wasteful time consuming "comebacks" and customer complaints. Simple application for new disc brake or previously installed disc brakes.

T5016C 4 oz. 12/cs.



CRC Lectra-Motive

The fast, easy way to clean and degrease all electrical systems and equipment. Dissolves and flushes away grease, oil and dirt. Cleans all metals without rinsing. Non-flammable.

T5018 20 oz. tube 12/cs.



CRC Contact Cleaner

A solvent cleaner degreaser designed especially for precision instruments, equipment and components. It also safely cleans plastic surfaces.

T5013 16 oz 12/cs.



NOCO Battery Cleaner

Spray-on battery cleaner works instantly to neutralize and dissolve corrosion from battery terminals and cables.

TE403 16 oz. 12/cs.



NOCO Corrosion Preventative

Prevents corrosion of battery terminals and cables. Easy to use spray can makes application simple.

TA202 16 oz. 12/cs.



GUNK Engine Cleaner

The ORIGINAL self-emulsifying degreaser. Quickly removes grease and grime. Spray it on . . . hose it off! For automobile, power mower, marine, farm and garden tractors and industrial machinery.

TEB1 20 oz. aerosol 12/cs.



GUNK Parts Cleaner

The world's most powerful parts cleaner for automatic transmissions and engine parts! Two layer, room temperature carbon digester and paint stripper. Safe on all metals, including aluminum.

THS5K 6 gal. w/basket

THS5LB 6 gal. pail

CHEMICALS

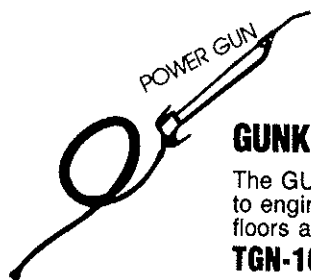

GUNK Power Gun

The GUNK Power Gun applies solutions to engines, machinery, tank trucks, floors and parts.

TGN-101



WD-40

Stops Squeaks. Finds squeaks and lubricates them in hard-to-get-at mechanisms. WD-40 is silicone free. No messy, gummy residue.

Protects Metal. WD-40 lubricates and protects against moisture and corrosive elements with an invisible barrier.

Loosens Rusted Parts. Frees sticky mechanisms. WD-40 penetrates

deep to free up frozen or rusted metal parts and fasteners. Keeps controls and linkages working freely.

Displaces Moisture. WD-40 gets under water, drives it off and keeps it off. WD-40 is a nonconductor. Use it to dry out electrical and electronic equipment.

T40015 12 oz. spray 12/cs.

T40101 1 gal. 4/cs.



SILICONE LUBE

Stops squeaks, sticking and freezing. Lubricates and prolongs life of rubber weather stripping on windows, doors, hoods, etc. Lubricates fan belts, window channels, trailer winches, etc. Poly extension tube attached to can.

SL15 16 oz. 12/cs.

TBF12 12 oz.



GOLD EAGLE Spray Gum Chaser

For fast, convenient cleaning of carburetors, automatic chokes, manifold heat controls and PCV valves. Leaves no filmy residue. With poly-extension tube for easy application.

TGC15 12/cs.



GOLD EAGLE Starting Fluid

A highly volatile priming fluid for starting all internal combustion engines. Saves starter and battery. Reduces engine wear.

TSF15 12/cs.



GOLD EAGLE Gas Line Antifreeze

Safe for use with unleaded gasoline and for cars equipped with catalytic converters. Prevents frozen gas lines and carburetor icing by absorbing water in the fuel system. Insures easy starting and protects against stalling in cold weather.

THT12 11 oz. 24/cs.



GOLD EAGLE ISO-Supreme Fuel Antifreeze & Dryer

Absorbs 500% more water dissolved in fuel than methyl alcohol based products. Handy funnel bottle.

TSI12 12 oz. 24/cs.



GOLD EAGLE Rust Inhibitor

Stops and disperses rust, corrosion and scale. Protects all cooling system parts with a magnetic film. Prevents overheating, burned valves, knock and warped heads caused by inadequate corrosion inhibitor.

TAR12 24/cs.



GOLD EAGLE Rapid Flush

Removes rust, scale, grease and lime in one fast easy operation. Safe for aluminum, copper, brass and rubber parts. Can be used with old antifreeze before draining.

TRF12 24/cs.

CHEMICALS



GOLD EAGLE Lock Thaw

Thaws out and prevents freezing of all locks. Does not gum up or harden in severe sub-zero temperatures. Will not harm auto finish.

TLT1 1 oz. btl. 24/cs.
TLT2 5/8 oz. spray 12/cs.



GOLD EAGLE De-Icer

Instant spray melts ice on windshield. Guaranteed to spray at sub-zero temperatures. Does not smear windshield. Harmless to auto finish.

TLT14D 12 oz. 12/cs.

Windshield Washer

Contains special additives to remove road film, salt and bugs; ammonia for crystal-clear cleaning and perfume for a pleasant aroma. Convenient, ready-to-use—no mixing necessary. Harmless to car finish. Protects to -20°F. Tamper-proof, leakproof inner seal.

TCHG gal. 6/cs.
TAW55 55 gal. drum
TKL55 55 gal. concen.

GOLD EAGLE Rubber Lube

For use in mounting and demounting tires. Eliminates squeaks and preserves rubber parts. Makes rubber accessories look like new.

T6003 gal. 4/cs.



GOLD EAGLE Wonder Wash

A soapless detergent that speeds and improves car washing. Sponge it on, hose it off... quickly without leaving streaks, spots or stains. Safe for all auto finishes.

T1016 16 lb. can
T1033 33½ lb. can



GOLD EAGLE Floor Cleaner

Heavy-duty powder cleans the dirtiest concrete floors and driveways. Works fast and easy.

T5050 50 lb. can
T5150 150 lb. can



BARS LEAK Radiator Sealant

Heavy duty stop leak. Lasting block, radiator and head gasket leak repair. Absolutely no seepage. Also scale and rust remover, and water pump seal lubricant.

TR6 12/cs.



CHAIN & CABLE FLUID

A superior penetrating, cleansing, non-gumming, lubricating protective spray. Ideal for many marine, automotive and household applications as well as chains and cables.

N13563 12 oz. 12/cs.



ELL BEE LUBES Wheel Bearing Grease

All purpose auto, truck and boat lubricant. Used for bearings, chassis U-joints and other applications.

TCS24 1 lb. can 24/cs.
TCS6 5 lb. can 6/cs.

CHEMICALS



LUBRIPLATE Gear Shield - Extra Heavy

A specialized, extreme pressure lubricant that penetrates and adheres. It resists water wash-off and is unaffected by temperature extremes. Use on: pinions, wire ropes, springs, chains, open gears, guide pins, elevating screws, slide racks.

N15263 14 oz. aerosol 12/cs.



LUBRIPLATE Wheel Bearing Grease

A special high temperature wheel bearing grease for home and shop use. Used for bearings, chassis and u-joints.

T22001 1 lb. can 24/cs.



LUBRIPLATE SMP Grease

A super multi-purpose, high-temperature, water repellent, extreme pressure automotive grease. Ideal for wheel bearings, chassis, brakes, universal joints, ball joints, and general automotive applications.

TSMP 14½ oz. 10/cs.



LUBRIPLATE Spray Lube 'A'

Sprays like fluid—firms up to a grease. For hinges, locks, auto hardware, battery terminals, hood and trunk hinges and latches.

TLAS 12/cs.



LUBRIPLATE Brake Lube

Multi-purpose super grease. Used for auto, truck and boat applications. Ideal for wheel bearings.

T110-1 24/cs.



LUBRIPLATE Lubricant

Motor assembly grease. A smooth, light bodied, water repellent grease used in the assembly of new engine parts.

T105GL 10 oz. 36/cs.



AGS SIL-GLYDE Lubricating Compound

(CONTAINS SILICONE) A longer lasting, high film strength lubricant for all surfaces. Safe on rubber, metal, wood, plastic and glass. Weatherproof—performs from 20° below zero to +400° F.

TSG4 4 oz. tube 12/cs.

TSG8 8 oz. tube 12/cs.



AGS LITH-EASE White Lithium Grease

Top grade multi-purpose white lithium grease for auto, farm, marine and shop. Superior film strength, water and heat resistance and rust protection. All temperature—all weather.

TWL15 1 lb. tub 12/cs.

TWL16 1 lb. aerosol 12/cs.



CHEMICALS



AGS Door-Ease

Use to lubricate all exposed surfaces—prevents squeaks, wear and rust. Stops sticking.

TDE-3 shop size 6/bx.



AGS Belt-Ease

A long lasting crystal-clear belt dressing that adds traction; silences squeaks, and helps preserve fan belts, V-belts, and other drive belts in all climates.

TBD-6 5.5 oz. aerosol 12/cs.



AGS Lock-Ease Lock Fluid

Use for year-round lock protection. Seals out moisture and protects against lock freeze-up. Helps locks work easier, prevents sticking, guards against rust and corrosion.

TLE4 3.4 oz. btl. 12/cs.

TLE5 3.5 oz. spray 12/cs.



NO DUST Florsweep

For cleaning wood and cement floors. Helps control dust in air during clean up.

T100LB

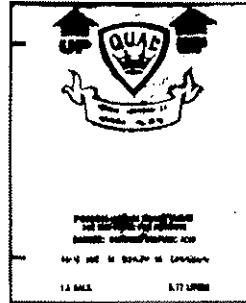

BATTERY ACID

HZPAK 6 qt.

H5GAL 5 gal.



MR. MELT

Starts melting ice and snow immediately from driveways, walks, stairways, etc. Greatly increases traction under car wheels and leaves little or no white residue. Calcium Chloride.

T100M



OIL DRY

The only all-purpose oil and grease absorbent made with the Hydra-Lite process. It's so absorbent it can soak up far more than its own weight in oils, grease, solvents and other liquids.

40 lb. Bag.

T40ABS



Power Steering Fluid and Sealer

Mixes with all power steering fluids. Stops power steering squeaks. Safeguards against leakage by protecting seals and hoses.

TPFC 12/cs.



ADVANCE Extra Heavy Duty Brake Fluid

DOT 3. Meets all specifications. For all drum and disc brakes. Safe and quick to use.

TBF1 1 gal.

TBF5 5 gal.

CHEMICALS

REVEAL LEAK DETECTION SYSTEM

BLAK-RAY 15 Watt UV Inspection Lamp

Compact wand lamp allows inspection in tight areas. Designed for use under low-light conditions.

TBL15

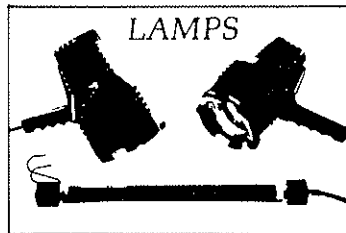

BLAK-RAY Self-Ballast 80 Watt UV

Inspection Lamp

Economical spotlamp. Lamp head plugs directly into standard wall outlet or extension cord. For use in well-lit areas. 4000 microwatts per sq. cm. of long wave UV.

TB100SP

REVEAL A/C Leak Additive

Designed for quick location of Freon leaks in automotive air-conditioning systems. Compatible with both Napthene and Parafin-based oil. Use with oil injector and any size Freon can. DILUTION: 1/4 oz. per standard automotive A/C system.

TA670 1/4 oz. bottle 12/box



REVEAL Oil Leak Additive

Designed for quick location of oil leaks in automobile engines and manual transmissions. DILUTION: 1 oz. per 4-5 fluid quarts of oil.

TA680 1 oz. bottle 6/box



REVEAL ATF Additive

Designed for quick location of ATF leaks in automatic transmissions and power steering systems. DILUTION: 1 oz. per 8-10 fluid quarts ATF.

TA682 1 oz. bottle 6/box



REVEAL Fuel Leak Additive

Designed for quick location of fuel leaks in gasoline and diesel fuel systems. DILUTION: 1 oz. per 4 gallons of fuel.

TA684 1 oz. bottle 6/box

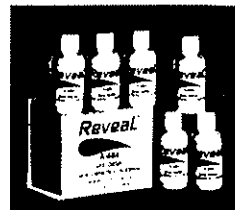

REVEAL Coolant Leak Additive

Designed for quick location of coolant leaks in engine cooling systems. DILUTION: 1 oz. per 2 gallons coolant.

TA690 1 oz. bottle 6/box



CHEMICALS

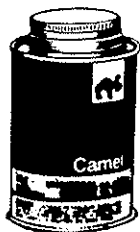

Tire Cement

Perfect cement for all repairs. Use on tires and tubes, double strength adhesion. Very fast drying.

T12086 pint 12/cs.



MUFFLER CEMENT

Requires no mixing or preparation. Dries hard as metal to seal joint and seam leaks and muffler burst holes.

T60Z 6 oz. size

T160Z 1 lb. shop size



Silicone Auto Seal

Bonds to metal, glass and fabrics. Waterproofs and insulates. Unaffected by vibration, most chemicals, and temperature changes. Stays permanently flexible. 10.67 fl. oz.

TSE1183 Black 5/ctn. 25/cs.

TSE1184 Clear 5/ctn. 25/cs.



JOHNSEN'S QUICK FLAT FIX With Hose Applicator

The most competitively priced tire inflator and sealer on the market. May be used on tube or tubeless tires, for all passenger car, motorcycle, bicycle and utility tires.

T3812TI 12 oz. 12/cs.



SPARKLE Glass Cleaner

Ideal for cleaning chrome, stainless steel, plastic, windows, mirrors and porcelain. Leaves no streaks. Contains only the highest quality ingredients. Leaves surfaces cleaner, longer.

T200Z 20 oz. spray can 12/cs.

T205 gal. 4/cs.



Anti-Freeze & Coolant

Protection for all four seasons and against excessive heat build-up. Cleans as it protects. Has been especially formulated to meet demands of today's high performance engines.

T57221120A 1 gal. 6/cs.

T57201740A 5 gal.



PROTECTOR Windshield Washer Anti-Freeze Concentrate

Protects to -46°F. Cleans and de-ices windshields. Conditions wiper blades. Permits use of windshield wipers at below zero temperatures.

TPR1 36/cs.



Refrigerant 12

Ideal for use in many charging stations. Handy disposable, no-return cylinder contains refrigerant of the highest quality.

P15FT 14 oz. can 12/cs.

P30LBF 30 lb. can



A/C Leak Detector

For use in automobile air conditioning, window units, freezers, refrigerators and any equipment using Refrigerant 12.

P15LDC 12/cs.

CHEMICALS



SERCON Refrigerant Oil

Quality 500 viscosity, wax-free, compressor oil for automotive air conditioning systems. One quart plastic bottle; printed calibrations to facilitate measured pouring.

G15117 1 Quart 12/cs.



SERCON Lubricant and Sealant

A high grade refrigerant oil in an aerosol spray can for the lubricating and sealing of parts during assembly or repair of air conditioning systems. Pressurized can.

P6552 10 oz. 12½/cs.



SERCON Refrigerant Oil Charge

Highest quality compressor lubricating oil replaces oil lost with refrigerant leaks. Easily charged into automotive systems without first removing compressor. Accurately measured, one can is appropriate charge for each three pounds of refrigerant in the system. Pressurized disposable can.

P6512 4 oz. 12/cs.



SERCON Vacuum Pump Oil

Promotes internal sealing for good vacuum and absorbs unwanted vapors from evacuated units. Regular oil changes promote longer vacuum pump life.

P6915 12 oz. 12/cs.



SERCON Aerosol Flush

A high quality flushing and cleaning agent for internal purging of automotive air conditioning systems. Essential when replacing compressor. Pressurized can.

P6542 32 oz. 12/cs.



SERCON Snap-A-Can

Slides over can and snaps shut, making tapping refrigerant cans faster and easier. Self-locking handles assure a positive, leak-free seal during charging and a built-in check valve prevents loss of can contents when charging is completed. Snap-A-Can fits any standard 2 5/8 diameter refrigerant can and an adaptor insert is included for 2" oil charge cans.

P8012 12/cs.

CHEMICALS

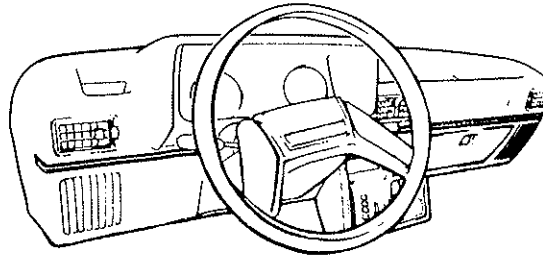

SPRAY PAINTS

The highest quality automotive paint available. Designed to meet all standards. 6/CASE

T98-042BUMPER BLACK

SEM

SEM INTERIOR COLOR SPRAY

Vinyl and plastic spray coating for flexible and rigid plastic, carpets, vinyl tops and vinyl upholstery.

T15003	Phantom White
T15013	Landau Black
T15023	Cordovan Brown
T15033	Saddle Tan
T15043	Shadow Blue
T15063	Burgundy
T15083	Silver
T15093	Light Buckskin
T15103	Super White
T15113	Firethorn Red
T15133	Wedgewood Blue
T15153	Mocha Coffee
T15173	Camel
T15183	Warm Gray
T15193	Light Blue Metallic
T15203	Mojave Rose

ADDITIONAL SEM PRODUCTS

T13023	Clear (Dull) Dashboard Spray
T39143	Trim Black Spray
T38348	Vinyl Prep (Pints)
T38363	Sand Free (Hard Plastic Prep)

SEM AEROSOL BUMPER COATERS

A single component colored coating. Can be used as a finish coat or as a primer coat on all urethane bumpers.

T39083	GM Black
T39073	GM, Toyota, Honda Gloss Silver
T39103	Universal Dark Gray
T39153	Ford Charcoal Gray
T39163	Ford Medium Smoke
T39183	Chrysler Medium Gray
T39193	Chrysler Dark Gray

CHEMICALS

IMPERIAL Machine Glaze

IMPERIAL Machine Glaze is a non-silicone, non-wax, machine glaze that possesses excellent scratch removal and filling characteristics and superior depth of shine and lustre. Recommended for use by machine to remove and fill swirl marks after compounding acrylic lacquer, it may also be applied to completely cured enamels and urethanes that have been compounded. IMPERIAL Machine Glaze is specially formulated to work on all vehicle colors.

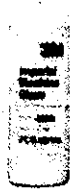

Part Number	Container Size	Containers Per Case
T 5991	Quart	1

IMPERIAL Microfinishing Glaze IMPERIAL Microfinishing Compound

IMPERIAL Microfinishing Glaze, PN05992, and IMPERIAL Microfinishing Compound, PN06031, are designed specifically for finishing fresh, 1 to 2 day old, enamel and urethane color and clear coat paint systems.



Part Number	Container Size	Quantity Per Case
T 5992	Quart	12
T 6031	Gallon	4

NEW

3M Super Weatherstrip Adhesive (Yellow)

For adhering all types of rubber weatherstripping to car doors and trunks. An excellent adhesive for bonding engine gaskets. Can be used for adhering vinyl trim headliners and side panels. Light colored adhesive. Very fast drying, exceptional bonding strength.



Part No.	Container Size	Containers Per Case
T 8001	5 oz. Tube	12

3M Super Weatherstrip Adhesive (Black)

3M Super Weatherstrip Adhesive (Black) is a strong, flexible, rubbery adhesive that withstands vibration and extreme temperature variations. This adhesive is primarily designed for use on T-Tops, Moon-Roofs and Sun-Roofs to provide the strength and rapid setting needed to hold weatherstripping and gaskets in place caused by the odd configurations these types of roofs have. Also, because of its black color, cleanup is eliminated due to its blending with the rubber.



Part No.	Container Size	Containers Per Case
T 8008	5 oz. Tube	12

3M Weatherstrip Adhesive (Black)

A black, fast drying adhesive used for bonding and sealing weatherstripping. Also an excellent adhesive for new E.P.D.M. weatherstripping. It is waterproof, easy to apply and remains flexible. Black color matches weatherstripping.

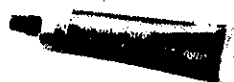

Part No.	Container Size	Containers Per Case
T 8011	5 oz. Tube	12

3M PREP TEAM Liquid Polish

Designed to be used by machine or by hand. 3M PREP TEAM Liquid Polish contains a cleaner for removing surface film and a wax for protective high gloss finish.



Part No.	Container Size	Containers Per Case
T 5939	½ Gallon	6

3M PREP TEAM All Purpose Cleaner

3M PREP TEAM All Purpose Cleaner is a powerful water based cleaner that does not attack paint, aluminum or fabrics. Actual cleansing power can be controlled by the amount of water added to the concentrate.



Part No.	Container Size	Containers Per Case
T 5946	Gallon	4
T 5948	5 Gallons	1

3M Super Duty Rubbing Compound

Part No. 051144-05955

Recommended for heavy aggressive compounding of paint. Clings to paint surface — remains wet on the job with little or no mess. Maintains high rate of cut with constant pressure. Buffs to high gloss with minimum of swirl marks. Can be used by hand or machine. Four. 1 gallon containers per case.



3M Fill 'N Glaze — Pink

Special product designed for use on dry, freshly painted surfaces for filling swirl marks after compounding. Let dry to a haze and wipe off by hand. Produces a long lasting deep luster finish.



Part No.	Container Size	Containers Per Case
T 5976	Gallon	4
T 5977	Quart	12

3M Final Glaze

3M Final Glaze fills swirl marks, produces a high gloss finish plus it offers protection to paint while curing. It is a non-silicone glaze and does not contain any wax. It comes in a convenient, easy to handle quart plastic bottle with a flip-top nozzle for quick and easy dispensing.



Part No.	Container Size	Containers Per Case
T 5988	Quart	12

IMPERIAL Hand Glaze

IMPERIAL Hand Glaze is a non-silicone, non-wax hand glaze, with high filling characteristics, excellent depth of shine and superior lustre. Recommended for use by hand to fill swirl marks after compounding acrylic lacquer, it may also be applied to completely cured enamels and urethanes that have been compounded. IMPERIAL Hand Glaze is specially formulated to work on all colors, and can be painted over.



Part No.	Container Size	Containers Per Case
T 5990	Quart	12

CHEMICALS

3M Fast Tack Trim Adhesive

A light colored extremely fast drying non-staining adhesive with long tack for attaching vinyl and other kinds of trim fabric, upholstery cloth, floor mats and carpeting, kick pads, silencer pads and convertible tops to painted or bare metal, wood, KB board or other fabric. Also useful as a gasket adhesive to hold gaskets in place while assembling parts.

Part No.	Container Size	Containers Per Case
T 8031	5 oz. Tube	12

3M Top and Trim Adhesive

A powerful contact adhesive for adhering vinyl tops. Is easily brushed or sprayed on and won't "grab" until firmly pressed in place. No staining of the vinyl or bleed thru. Ideal for various interior trim applications as well.

Part No.	Container Size	Shipping Weight
T 8046	5 Gal. Pail	38 lbs.
T 8049	54 Gal. Drum	401 lbs.

5 Gallon Pail equals 1 Case. 54 Gallon Drum equals 15 Cases.

3M Plastic and Emblem Adhesive

An excellent clear adhesive for plastic repair and emblem application. Use this strong, quick-drying adhesive for plastic or metal emblems, interior rigid plastic, tail light lenses, vinyl side moldings or upholstery.



Part No.	Container Size	Containers Per Case
T 8061	5 oz. Tube	12

3M General Trim Adhesive

A rapid drying, high strength, light colored adhesive in an aerosol container. Designed for bonding most types of material used in automotive trim operations except unsupported vinyl. Excellent for fabrics, upholstery, foam, jute pads, carpets, rebonding vinyl top sections, etc. Has adjustable spray pattern, high initial strength and does not require shaking or agitation before using. Provides good heat resistance.

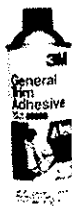

Part No.	Container Size	Containers Per Case
T 8080	24 oz. Aerosol	6

3M Super Tack Adhesive

3M Brand Super Tack Adhesive sprays easily, dries quickly to a super sticky film. Adheres to metals, cork, rubber, plastics and other automotive materials. Holds gasket in place, even overhead, but allows repositioning if needed. Resists water, anti-freeze/coolant solutions, gasoline, lubricating oil, transmission oil, brake fluid and grease. Blue color shows coverage. Narrow spray pattern cuts down overspray and reduces waste.

Part No.	Container Size	Containers Per Case
T 8082	16 oz. Aerosol	6

3M Super Trim Adhesive

3M Super Trim Adhesive is a fast acting, high strength, aerosol contact adhesive designed for two-surface application. This adhesive is resistant to heat and plasticizing oils and is excellent for attaching vinyl tops, headliners, vinyl trim, insulation, foam, padding, and rubber parts to metal and other surfaces. Bonds can be made within minutes of application or as long as one hour later.

Part No.	Container Size	Containers Per Case
T 8090	24 oz. Aerosol	6

3M Structural Adhesive

A two part general purpose structural adhesive that may be used for bonding auto glass to metal retainers and also for trim ornaments and miscellaneous fiberglass repair.

Part No.	Container Size	Kits Per Case
T 8101	2 -2 fl. oz./Kit	6

3M Quick Fix Adhesive (cyanoacrylate)

3M Quick Fix Adhesive (cyanoacrylate) is a strong, rapid bonding, convenient to use adhesive that has good adhesion to rubber weatherstripping, vinyl, metal, glass, side moldings, emblems, trim pieces and most plastics. This product has excellent resistance to temperature extremes, shock (such as slamming a door) and most automotive fluids.

Part Number	Size	Quantity Per Case
T 8155	1 oz. Bottle	12

3M FLEXICLEAR Body Seam Sealer

3M FLEXICLEAR Body Seam Sealer is a clear, non-sagging, very flexible seam sealer for sealing automotive as well as recreational vehicle seams and joints. This product may be used as received or can be mixed with paint to match existing finish. 3M FLEXICLEAR body Seam Sealer has exceptionally good tooling properties and is tack free in about 15 minutes.

Part No.	Container Size	Containers Per Case
T 8405	Fits 1/2 Gallon Cartridge Gun	12

3M All-Around Autobody Sealant (White)

3M All-Around Autobody Sealant can be used for sealing interior and exterior autobody joints and seams. It applies easily, can be smoothed to a feather-edge with a wet finger and sets to a firm, tough, rubber-like water resistant bead. It can be painted over in about 30 minutes, will not mar or harm existing paint finish and can be cleaned off with water before it dries.



Part No.	Container Size	Containers Per Case
T 8500	Fits 1/2 Gallon Cartridge Gun	12

3M Fast 'N Firm Seam Sealer

3M Fast 'N Firm Seam Sealer is a firm setting product for sealing interior and exterior joints. Adheres well to clean, bare metal, primed metal and painted surfaces. Skins over quickly, can be painted in about 30 minutes. Has excellent tooling and sanding properties and exhibits low shrinkage and good resistance to weathering after cure. Also ideal as a general purpose water and dust sealer. Will withstand mild forced drying.



Part No.	Container Size	Containers Per Case
T 8505	Fits 1/2 Gallon Cartridge Gun	12

3M Auto Bedding and Glazing Compound

A non-hardening water resistant, medium bodied sealer for sealing auto body, seams, under moldings and between windshield rubber and car body. Remains permanently soft and pliable without shrinking to absorb movement in the auto body. Neutral color is clean and easy to use, black color eliminates clean-up on windshield rubber, etc. Easy to Use — Stop-Flo Plunger on each cartridge prevents oozing. Has dry rag cleanup.

Part No.	Container Size	Containers Per Case	Color
T 8509	Fits 1/2 Gal. Cart. Gun	12	Black

CHEMICALS

3M Heavy Drip-Check Sealer (Gray)

An easy-to-use, fast drying flexible rubber sealer. Has the right flow to permanently seal small cracks and openings. Ideal for use in drip rails, moldings, cowlings and welded seams. Can be painted within 30 minutes. Heavy Type for sealing vertical seams. Resists most automotive fluids.

Part No.	Container Size	Containers Per Case
T 8531	5 oz. Tube	12

3M Clear Auto Sealer

A non-yellowing, optically clear sealer for sealing windshields, drip moldings, reveal moldings, truck ornaments, taillights, and other small seams on the auto body. Also useful for sealing convertible tops and matching convertible back lights.



Part No.	Container Size	Containers Per Case
T 8551	5 oz. Tube	12

3M Strip-Calk

For sealing openings in the car body where a soft non-hardening material is needed. Good for use in seams, cracks in joints, trunks, cracks around pillar posts, cowlings and windshields. Strip-Calk is waterproof, will not shrink, requires no application tools, can be painted.

Part No.	Container Size	Containers Per Case	Color
T 8568	Box of 60 1 ft. Lengths	12	Gray
T 8575	Box of 60 1 ft. Lengths	12	White
T 8578	Box of 60 1 ft. Lengths	12	Black

3M WINDO-WELD Sealer (Black)

This sealer is a one-part polysulfide adhesive sealant designed for use in the replacement of "bonded" Windshields and backlites. Also ideal for providing a supplementary seal for windshields installed with Butyl Tape. Requires no primer.



Part No.	Container Size	Containers Per Case
T 8606	Fits 1/2 Gallon Cartridge Gun	12

3M WINDO-WELD Sealer-Urethane (Black)

A one part adhesive sealant designed specifically for use in the replacement of "bonded" windshields and backlites. It features excellent handling, performance and curing properties that make it ideal for the reinstallation of automotive glass. Requires no primer.

Part No.	Container Size	Containers Per Case
T 8607	Fits 1/2 Gallon cartridge Gun	12

3M Super Fast Urethane (Black)

3M Super Fast Urethane is a rapid-curing adhesive/sealant intended for all flush mounted and bonded windshield or backlite replacements. This black, odorless product is easily applied, cures quickly and provides the necessary strength for automotive glass replacement.

Part No.	Container Size	Containers Per Case
T 8609	10 fl. oz. cart.	12

3M WINDO-WELD Ribbon Sealer (Black)

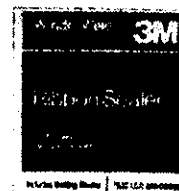

WINDO-WELD Ribbon Sealer is a "Tape type" sealer used in the replacement of windshields and backlites on all "gasket-less" car models. Its unique feature of "controlled" compressibility allows easy installation yet will not squeeze out or allow lite to contact pinch-weld.

One kit or one 15 Ft. Roll is sufficient material to replace one windshield or backlite. One 30 Ft. Roll is sufficient material to replace two windshields or backlites.

Part No.	Container Size	Kits Per Case
INDIVIDUAL KITS — Round Bead Contains one roll of sealer and setting blocks.		
T 8610	Kit — 1/4" x 15 ft.	12
T 8611	Kit — 5/16" x 15 ft.	12
T 8612	Kit — 3/8" x 15 ft.	12

3M WINDO-WELD Resealant (Black) (Flow Grade)

Developed to stop leaks in new cars installed with "bonded" windshield and backlites, useful as a supplementary seal when windshields are repaired with WINDO-WELD Ribbon Sealer. Flows easily in pinholes and crevices and around retainer clips and spacer blocks. Dries fast and remains flexible. Adheres to glass, painted metal and synthetic rubber sealers.



Part No.	Container Size	Containers Per Case
T 8633	Pint Can†	6
T 8634	Fits 1/2 Gallon Cartridge Gun	12

†For use with **08994** Applicator Gun.

3M Channel Bonding Adhesive

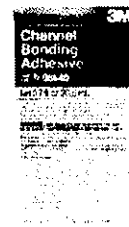

A highly flexible, fast curing, 2-part epoxy adhesive designed for bonding auto glass into metal channels. Cured bonds are durable and resist vibration. Will also bond steel, aluminum, wood, plastic and fiberglass. Unique package provides ease of mixing and application.

Part No.	Kit Size	Kit Per Case
T 8640	7 fl. oz.	36

3M Automotive Joint and Seam Sealer

3M Automotive Joint and Seam Sealer is a firm setting, but flexible sealer for interior and exterior auto body joints and seams. Typical applications are in the trunk, floor, and wheel well areas. Adhesion and weathering resistance are excellent. Skins over quickly. Can be painted in about 30 minutes. Available in white and black.

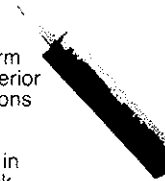

Part No.	Color	Container Size	Containers Per Case
T 8646	White	Fits 1/2 Gallon Cartridge Gun	12

CHEMICALS

3M Brushable Seam Sealer (Gray)

3M Brushable Seam Sealer has been specially developed to seal sheetmetal overlap joints that have been spot welded, riveted or bolted together. Applied with a stiff, short bristle brush, it dries quickly without sag or flow to restore factory appearance. It can be painted when dry. Brushable Seam Sealer adheres well to bare or painted metal surfaces, remains flexible and resists oil, fuel and other automotive fluids. Use for sealing floor pans, firewalls, trunk seams, shock absorber mounting towers, around wheelwells, fuel filler splash pans and around headlight and taillight openings.



Part No.	Container Size	Containers Per Case
T 8656	Quart	6

3M Liquid Gasket

An Anaerobic Form-In-Place Gasketing compound designed for the sealing of machined metal-to-metal surfaces. 3M Liquid Gaskets Cures, in the absence of air, to a tough resilient seal. Liquid Gasket effectively seals against most automotive fluids and gases, will not shrink and fills gap up to .030. To increase gap filling abilities, use 3M Accelerator/Cleaner, Part No. 051135-08958. When used with Accelerator/Cleaner, 3M Liquid Gasket is also effective for thread locking and sealing.



Part No.	Container Size	Containers Per Case
T 8659	15cc Blister Pak	10

NOTE: 3M Liquid Gasket will fill gaps up to .050 when 3M Accelerator Cleaner is used prior to applying the sealant to the parts to be sealed. 3M Accelerator/Cleaner **must be used** when sealing non-ferrous metals (i.e. aluminum) with 3M Liquid Gasket.
*Discontinued as a part numbered item.

3M T-3 Silicone — Red-High Temp Gasketing Compound

A premium grade silicone gasketing compound for formed-in-place automotive engine gaskets. 3M T-3 Silicone has been specifically designed for replacing standard silicone compounds in oxygen sensor equipped engines. T-3 will operate at higher temperatures (600°F +), resist most automotive fluids and meets non-corrosive specifications when required. It can be used for valve cover, thermostat, oil pan, intake manifolds or for any formed-in-place gasket where silicones are used. 3M T-3 Silicone meets or exceeds all current O.E.M. specifications for formed-in-place automotive engine silicone gaskets.



Part No.	Container Size	Containers Per Case
T 8660	3 oz. tube	6

T-3 Silicone — Black-High Temp Gasketing Compound

This form-in-place gasket sealant offers the same proven leak-stopping characteristics as the original T-3. Now you can match OEM formed-in-place silicone sealants and most engine parts with T-3 Silicone-Black. T-3 meets OEM volatility specifications for oxygen-sensor equipped engines, is non-corrosive, stays flexible from -20°F to 600°F and effectively resists hot oil, ethylene glycol solutions and other automotive fluids.



Part Number	Container Size	Tubes Per Case
T 8670	3 fl. oz. Tube	6

3M Super Silicone Sealant

A rapid curing adhesive/sealant formulated to solve repair and maintenance problems. Excellent gasket adhesive and formed-in-place gasket material. Adheres to a wide variety of automotive surfaces.



Part No.	Color	Container Size	Containers Per Case
T 8661	Clear	3 oz. Tube	12
T 8662	Black	3 oz. Tube	12

3M Super Silicone Sealant

A paste-like, non-sagging, moisture-curing, silicone rubber sealant. Useful for repair and maintenance applications. Remains flexible with excellent resistance to weather, temperature extremes and aging. Adheres to bare and painted metal, glass, non-oily woods, many plastics and abraded rubbers. Excellent gasket adhesive and formed-in-place gasket material.

Part No.	Color	Container Size	Containers Per Case
T 8663	Clear	Fits 1/2 Gal. Cart. Gun	12
T 8664	Black	Fits 1/2 Gal. Cart. Gun	12
T 8665	White	Fits 1/2 Gal. Cart. Gun	12

3M Body Schutz Rubberized Coating

A fast drying, rubberized protective coating developed to coat, protect and sound deaden a wide variety of automotive parts — door skins, quarter panels, wheelwells, fenders, etc. Excellent resistance to salt spray, weathering and abrasion. Excellent adhesion to steel, primer and automotive paints. For painting, follow the paint manufacturing system for painting flexible surfaces.

Part No.	Container Size	Containers Per Case
T 8864	Quart Can	6

3M Rocker Schutz (Beige)

3M Rocker Schutz is a fast drying, paintable, chip-resistant coating for use on motor vehicles that resists weathering, salt spray and abrasion. It matches the original textured coating found on rocker panels, valances, etc., and is paintable 30 minutes after application. 3M Rocker Schutz should be applied with our 3M Body Schutz applicator Gun Part No. 051135-08997.

Part No.	Container Size	Containers Per Case
T 8874	Quart Can	6

UNDERSEAL Brand Rubberized Undercoating

A rapid drying, rubberized undercoating in an aerosol container. Ideal to coat, protect or sound deaden door skins, quarter panels, wheelwells, fenders, etc. Aerosol container permits convenient access to difficult to reach areas. Excellent resistance to salt spray, weathering and abrasion. Excellent adhesion to steel primer and automotive paints. If painted, a "flex agent" must be added to the paint.



Part No.	Container Size	Containers Per Case
T 8883	24 oz. Aerosol	6

CHEMICALS

3M Rust Fighter — I (Internal Coating Compound)

3M rust Fighter-I is an amber-colored, runny product ideal for restoring corrosion protection during the spot repair of hemming flanges, door skins, rocker panels, etc. Rust Fighter-I is intended for use as an internal coating compound. It remains tacky, flexible and pliable after application.



Part No.	Container Size	Containers Per Case
T 8892	24 oz. Aerosol	6

3M Rust Fighter — E (External Coating Compounding)

3M Rust Fighter-E is a black, abrasion-resistant coating ideal for corrosion protection and sound deadening when applied to quarter panels, wheelwells, fenders, etc. Rust Fighter-E sprays easily, dries quickly, and can be used for coating small and/or repaired areas. Rust Fighter-E is intended for use as an external coating compound.



Part No.	Container Size	Containers Per Case
T 8893	24 oz. Aerosol	6

3M "4-Way"

A specialized formula for general or all-around use. It provides characteristics of a lubricating oil, a penetrating oil, a demoisturizing coating, a thin bodied, transparent rust preventative coating. Literally, a "4-1" general purpose spray material which contains no silicone.



Part No.	Container Size	Containers Per Case
T 8902	24 oz. Aerosol	6

3M Choke and Carb Cleaner (Through-the-Engine Formula)

- Oxygen sensor safe
- Professional size
- High delivery rate
- Handy snorkel tube

New formula allows product to be used on hot, cold or running engine. Powerful penetrating ingredients loosen gum, oil and varnish. High delivery rate flushes away loosened deposits and leaves no residue on carburetor or linkage. Use on automatic chokes, carburetor assemblies, linkage, heat riser valves and PCV systems.



Part No.	Container Size	Containers Per Case
T 8904	24 oz. Aerosol	6

3M Brake Cleaner

A high delivery Brake Cleaner which effectively removes oil, grease, brake fluid, dirt and other contaminants from all types of brake assemblies and parts without disassembling the unit. Product leaves no residue.



Part No.	Container Size	Containers Per Case
T 8906	24 oz. Aerosol	6

3M Woodgrain and Stripe Remover

For removing Woodgrain Vinyl and Vinyl Stripes from Acrylic enamel surfaces. Jelly-like consistency keeps remover in place on vertical surfaces to promote fast action when sprayed from the aerosol can. Saves on repair and repaint. Removal is facilitated by use of plastic scraper. Part No. 051135-08990. For removal of adhesive residue follow up with use of Part No. 051135-08908 Adhesive Remover.



Part No.	Container Size	Containers Per Case
T 8907	24 oz. Aerosol	6

3M Woodgrain and Stripe Adhesive Remover

Cleans off adhesive residue after Woodgrain Vinyl or Vinyl Stripes have been removed. This fast acting remover can be used on all acrylic enamel painted metal surfaces. Jelly-like consistency keeps remover in place on vertical surfaces to promote fast action when sprayed from an aerosol can. Removal is facilitated by use of plastic scraper Part No. 051135-08990. Saves on repair and repaint of the metal surface.



Part No.	Container Size	Containers Per Case
T 8908	24 oz. Aerosol	6

Gasket Prep and Parts Cleaner

Gasket Prep and Parts Cleaner is a high quality, fast drying chlorinated solvent that offers residue free cleaning and does not affect the cure rate of form-in-place gasket sealants or gasket adhesive/sealants. The unique valve system permits cleaning of hard to reach areas since it can be sprayed in any position. The use of Gasket Prep and Parts Cleaner saves the mechanical technical time and helps to prevent costly comebacks.



Part No.	Container Size	Containers Per Case
T 8909	24 oz. Aerosol	6

3M Multi-port Fuel Injector Cleaner

3M Multi-port Fuel Injector Cleaner is designed to quickly remove varnish, gum and other deposits from multi-port style fuel injectors. Conveniently applied through the 3M Universal Injector Cleaner Hose, it restores injector efficiency and improves fuel atomization...engines run smoother and better.



Part Number	Size	Quantity Per Case
T 8912	16 oz. Aerosol	6

3M Universal Injector Cleaner Hose

The 3M Universal Injector Cleaner Hose is designed for use with 3M Multi-port Fuel Injector Cleaner. The 3M Universal Injector Cleaner Hose must be used with Adaptors shown below.

Part Number	Quantity Per Case
T 8914	10

CHEMICALS

3M Multi-port Fuel Injector Cleaner Adaptors

Designed to fit vehicles equipped with multipoint fuel injection. Adaptor mounts in universal fitting of the 3M Universal Hose Assembly for use with 3M Multi-port Fuel Injection Cleaner.

Part Number	Vehicle Type	Quantity Per Case
T 8916	Replaced by 08931	10
T 8917	GM/Chrysler	10
T 8918	Honda	10
T 8919	Toyota	10
T 8920	Nissan/Mazda	10
T 8921	Volvo LH-Jetronic	10
T 8922	GM Throttle Body	10
T 8929	Toyota - Cold Start	10
T 8931	Ford Quick Disconnect	10

NEW

The TBI Flow Restrictor, designed for use with the 3M Injector Cleaner Hose, P.N. 08914, and the appropriate vehicle adaptor, allows the use of 3M Multi-port Fuel Injector Cleaner without the need to clamp return lines. The flow restrictor simply reduces the flow of cleaner to meet the requirements of low pressure TBI and CFI systems without returning the cleaner to the fuel tank.

Part Number	Quantity Per Case
T 8932	10

NEW

3M Lithium Lubricant

Heavy bodied lubricant with snorkel spray for hard to get at areas. Excellent on all metal to metal parts. Useful for window regulators, hood and trunk hinges.

Part No.	Container Size	Containers Per Case
T 8915	24 oz. Aerosol	6



3M Penetrant

Penetrates deep — frees rusted nuts, bolts, screws, etc. Also, lubricates and protects against corrosion.

Part No.	Container Size	Containers Per Case
T 8925	24 oz. Aerosol	6



3M Silicone Lubricant (Dry Type)

A silicone lubricant. Contains no petroleum oils. Seals out moisture, eliminates rubber squeaks, prevents sticking, retards corrosion.

Part No.	Container Size	Containers Per Case
T 8935	24 oz. Aerosol	6



3M Silicone Lubricant Plus (Wet Type)

A high solids silicone lubricant that provides a long "Wet" appearance and increases sliding or lubricating qualities.

Part No.	Container Size	Containers Per Case
T 8936	24 oz. Aerosol	6

3M Belt Dressing

3M Belt Dressing is designed to stop squeaking and reduce wear of automotive "V" belts without being harmful to the belts. The smaller size container fits easily into the tight areas and its special valve allows spraying with the container upside down.

Part No.	Container Size	Containers Per Case
T 8947	16 oz. Aerosol	6



3M Release Agent

A special solvent blend that quickly softens adhesive bonds between automotive weatherstrip and metal. Also works rapidly to soften the bond between auto glass and rubber grommets on automobiles and trucks having rubber-set installations.

Part No.	Container Size	Containers Per Case
T 8971	24 oz. Aerosol	6



3M General Purpose Adhesive Cleaner

A specially blended solvent that provides easy cleanup of most types of adhesives and quickly removes waxes, road tars, grease, oil and similar materials. Will not harm thoroughly dried automotive paint, vinyl or fabrics when properly used.

Part No.	Container Size	Containers Per Case
T 8984	Quart Can	6



3M Cartridge Applicator Gun

Part No. T 8992

1/2 gallon Cartridge Gun for use with Auto Bedding and Glazing Compound and Windo-Weld Sealer. Twelve per case.



3M Applicator Gun

Part No. T 8994

For applying 3M Automotive Adhesives and Sealers. Gun is furnished with two tips. Windshield Sealer application tip and an all purpose needle tip. Twelve per case.



3M Body Schutz Applicator Gun

Part No. T 8997

Developed to provide a unique, convenient and inexpensive means of spraying 3M Brand Rubberized Body Schutz Coating. One per case.



AUTO-PAK SCOTCHGARD Upholstery Protector

AUTO-PAK SCOTCHGARD Upholstery Protector protects upholstery fabrics against oil and water based stains.

Part Number	Size	Quantity Per Case
T 3572	14 oz. Aerosol	6

BODY SHOP SUPPLIES

SECTION 7

	PAGE
ADHESIVE CLEANER.....	12
ADHESIVE TOP & TRIM.....	9
ADHESIVE WEATHER STRIP.....	8,9
ALL PURPOSE CLEANER.....	4
BODY CAULKING.....	10,11
BODY FILES.....	13
BODY FILLER DISPENSER.....	12
BODY FILLER HARDENER.....	12
BODY FILLERS.....	12
BODY SCHUTZ.....	11
BONDING ADHESIVE.....	9
BUFFING PADS.....	4
CAULK GUNS.....	12
CHANNEL BONDING ADHESIVE.....	11
CLEAN N STRIP DISCS.....	8
CURTAINS.....	13
CYANOACRYLATES.....	10
DISC ADHESIVE.....	9
DRIP CHECK SEALER.....	10
EMBLEM ADHESIVE.....	9
FIBERGLASS CLOTH, RESIN.....	13
FIBERGLASS CURTAINS.....	13
FINESSE-IT SYSTEM.....	4
FLEXIBLE BUMPER REPAIR.....	4
GASKET REMOVAL DISCS.....	8
GLAZES.....	5
GLAZING COMPOUNDS.....	10
GRINDING DISCS.....	7
HARDENER.....	13
HEAT LAMP.....	13
HOOD FLUTTER REPAIR KIT.....	9
JOINT SEALERS.....	10,11
MASKING PAPER.....	6
MASKS-RESPIRATOR.....	7,8
POLISH & GLAZE.....	4,5
POLYESTER RESIN.....	13
RESPIRATORS.....	7,8
RIBBON SEALER.....	11
ROCKER SCHUTZ.....	11
RUBBERIZED BODY SCHUTZ.....	11
RUBBING COMPOUND.....	4

SANDING & SANDPAPERS.....	1,2,3
Crocus Cloth.....	3
Cut Off Wheels.....	2
Disc Pads.....	4
Emery Cloth.....	3
Free Cut Sheets.....	3
Gold Discs.....	1
Green Corps.....	1,2
Imperial Color Sheets.....	2
Paint Buster Discs.....	2
Production Discs.....	1,2
Production Sheets.....	2,3
Roloc Discs.....	1
Roloc Disc Pad.....	3
Rubber Squeegees.....	3
Stick-it Discs.....	1
Stick-it Dispenser.....	3
Stick-it Sheets.....	3
Trimite Sheets.....	2
Wet or Dry Sheets.....	2
SCOTCH BRITE DISCS.....	8
SCOTCH BRITE PADS.....	8
SEAM SEALERS.....	10,11
SPREADERS.....	13
STRIPCALK.....	10
STRIPE REMOVER.....	12
STRUCTURAL ADHESIVE.....	9
TAPES:	
Air Conditioning Tape.....	14
Attachment Tape.....	6
Box Sealing Tape.....	7
Cloth Tape.....	7,14
Electrical Connector Tape.....	5
Electrical Tape.....	14
Filament Tape.....	14
Fine Line Tape.....	6
Masking Tape.....	6,14
Moulding Tape.....	6
Pipe Sealant Tape.....	5
Plastic Tape.....	5,6
Tape Dispensers.....	7
Vinyl Tape.....	5
3M PREP TEAM, CLEANERS, POLISHES.....	4,5
3M RUST FIGHTER.....	11
TRIM ADHESIVE.....	9
URETHANE SEALERS.....	10
WEATHERSTRIP ADHESIVE.....	8,9
WEATHERSTRIPPING.....	14
WHEEL MASKERS.....	13
WINDOW WELD SEALER.....	10,11
WOODGRAIN REMOVER.....	12

BODY SHOP

PRODUCTION FRE-CUT Gold Paper Discs

Dry sanding only. PRODUCTION FRE-CUT Gold Paper Discs have a sharp mineral to cut through tough surfaces faster. All new construction resists dulling, loading and edge wear. Discs are available in "A" weight in a full range of discs.

Part No.	Grit	Size	Discs Per Box	Boxes Per Case
T 1023	220A	5" Diameter	100	10
T 1040	150A	6" Diameter	100	10
T 1041	120A	6" Diameter	100	10
T 1043	80A	6" Diameter	100	10

TRI-M-ITE FRE-CUT Paper Discs (Open Coat)

Dry sanding only. Special treatment for minimum loading. Use on disc machines for sanding old finishes, fine feather-edging and sanding primer surfacer.



Part No.	Grit	Size	Discs Per Box	Boxes Per Case
T 1109	320A	6" Diameter	250	4
T 1111	240A	6" Diameter	250	4
T 1112	220A	6" Diameter	250	4
T 1113	180A	6" Diameter	250	4
T 1115	120A	6" Diameter	250	4
T 1117	80A	6" Diameter	250	4

PRODUCTION Paper Discs (Open Coat)

Dry sanding only. Used on various disc machines for plastic filler shaping and finishing, for light paint removal and feather-edging. Open coat resists loading.

Part No.	Grit	Size	Discs Per Box	Boxes Per Case
T 1133	80D	6" Diameter	100	5
T 1136	40D	6" Diameter	100	5
T 1143	80D	8" Diameter	100	5
T 1146	40D	8" Diameter	100	5
T 1149	36D	8" Diameter	100	5

PRODUCTION FRE-CUT Paper Discs (Open Coat)

Dry sanding only. Special treatment for minimum loading. Use for light paint removal, plastic filler finishing and feather-edging.

Part No.	Grit	Size	Discs Per Box	Boxes Per Case
T 1285	80D	6" Diameter	100	5

GREEN CORPS ROLOC Discs

GREEN CORPS ROLOC Discs combine the versatility of ROLOC with the premium quality of GREEN CORPS. It is a handy quick change tool for disc grinding which fits any standard 1/4" drill or air tool. A quick 1/2 turn on, 1/2 turn off speeds disc changing and cuts down time. Roloc discs are color coded. The grit of any disc can be determined by the color of the plastic holding button. Grit 50 — green, grit 36 — brown, grit 24 — black.



Part No.	Grit	Size	Discs Per Box	Boxes Per Case
T 1406	50	3" Diameter	25	10
T 1408	24	3" Diameter	25	10

STIKIT Gold Disc-Rolls

STIKIT Gold Discs are a more durable and Longer Lasting Disc product. They come in roll form and are available in "A" weight in a full range of grits. Discs have a pressure sensitive adhesive for easy application and removal.



Part No.	Grit	Size	Discs Per Roll	Rolls Per Case
T 1419	400A	5" Diameter	175	6
T 1421	280A	5" Diameter	175	6
T 1428	80A	5" Diameter	125	10
T 1434	400A	6" Diameter	175	6
T 1435	320A	6" Diameter	175	6
T 1436	280A	6" Diameter	175	6
T 1437	240A	6" Diameter	175	6
T 1438	220A	6" Diameter	175	6
T 1439	180A	6" Diameter	175	6
T 1441	120A	6" Diameter	125	10
T 1443	80A	6" Diameter	125	10

STIKIT TRI-M-ITE Disc Rolls

Discs by the roll used with STIKIT Disc Dispenser Part No. 051144-05450. Discs are specially treated for minimum loading and have pressure sensitive adhesive backing for easy-on — easy-off application to STIKIT Disc Pad Part No. 051144-05575 — 5", Part No. 051144-05576 — 6".

Part No.	Grit	Size	Discs Per Roll	Rolls Per Case
T 1465	320A	6" Diameter	250	4
T 1467	240A	6" Diameter	250	4
T 1468	220A	6" Diameter	250	4
T 1473	80A	6" Diameter	125	8

STIKIT Green Disc Rolls

STIKIT Green Discs are a more durable and longer lasting disc product. They have a Pressure Sensitive Adhesive Backing for easy application and come in roll form for easy dispensing from our STIKIT Disc-Roll Dispenser Part No. 051144-05450.



Part No.	Grit	Size	Discs Per Roll	Rolls Per Case
T 1506	80D	6" Diameter	100	10

GREEN CORPS PRODUCTION FRE-CUT Paper Discs

GREEN CORPS PRODUCTION FRE-CUT Paper Discs are a more durable and longer lasting disc product. A tough mineral/bond construction and a special treatment to resist loading provides a long lasting, fast cutting paper disc.

Part No.	Grit	Size	Discs Per Box	Boxes Per Case
T 1502	80D	5" Diameter	100	10
T 1507	80D	6" Diameter	100	10

STIKIT PRODUCTION Discs

Discs have pressure sensitive adhesive backing for quick application to disc pad. A special coating system makes these 5, 6, and 8" diameter discs cut faster and last longer. These Stikit discs resist loading and cut "down time" on the job.

Part No.	Grit	Size	Discs Per Box	Boxes Per Case
T 1540	80D	8" Diameter	50	5
T 1542	36D	8" Diameter	50	5

BODY SHOP

GREEN CORPS STIKIT PRODUCTION Discs

Individually lined, pressure sensitive adhesive backed discs for easy application to and removal from disc pad. All new mineral/bond construction and tough "E" wt. backing provides for a fast cutting, long lasting abrasive.



Part No.	Grit	Size	Discs Per Box	Boxes Per Case
T 1550	40E	8" Diameter	50	5
T 1551	36E	8" Diameter	50	5

GREEN CORPS STIKIT PRODUCTION FRE-CUT Discs

Individually lined, pressure sensitive adhesive backed discs for easy application to and removal from disc pad. Tough/mineral/bond construction along with special treatment to resist loading, means fast cutting, long lasting abrasive.

Part No.	Grit	Size	Discs Per Box	Boxes Per Case
T 1549	80D	8" Diameter	50	5

3M Type D Discs (Open Coat)

Long lasting discs, especially designed for paint removal and metal work. Resin bonding and open coat resists loading on acrylics and provides excellent mineral adhesion. Nine-inch discs at 4200 RPM; 7" at 5500 RPM. Resin Bonding — Heavy Fibre Backing — Aluminum Oxide Mineral.

Part No.	Grit	Size	Discs Per Box	Boxes Per Case
T 1819	24	5" x 7/8"	25	4
T 1868	24	9 1/8" x 7/8"	25	4

3M PAINT BUSTER Discs

3M PAINT BUSTER Discs are especially designed for removing paint quickly and efficiently and for metal working. Special resin bonding and a sharper, more durable aluminum oxide mineral makes these discs long lasting and resistant to loading or dulling, especially on acrylic paints. 9 1/8" discs at 4200 RPM — 7" discs at 5500 RPM and 5" at 7650 RPM.

Part No.	Grit	Size	Discs Per Box	Boxes Per Case
T 1881	24	5" x 7/8"	20	5
T 1907	24	9 1/8" x 7/8"	20	5

GREEN CORPS Fibre Discs

The GREEN CORPS Fibre Disc is an all purpose grinding disc for door skinning, grinding MIG welds or for any kind of metal grinding. These high performance grinding discs are long lasting and fast cutting for a whole new performance level in metal grinding.



Part No.	Grit	Size	Discs Per Box	Boxes Per Case
T 1915	24	5" x 7/8"	20	5
T 1923	24	7" x 7/8"	20	5
T 1929	24	9 1/8" x 7/8"	20	5

GREEN CORPS Cut-Off Wheels

The GREEN CORPS Cut-Off Wheel is a high performance, long lived Cut-Off Wheel 3"x1-16" in size, for use in cutting autobody sheet metal, frame rails, clamps and rusted bolts. For use on utility type Cut-Off tools. Read all warnings supplied with wheels. Do not use on tools without guards.



Part Number	Size	Wheels Per Pack	Packs Per Case
T 1990	3" x 1-16"	5	10

WETORDRY TRI-M-ITE Paper Sheets

Use wet with water or dry for sanding old finishes, fine feather-edging and surface sanding. WETORDRY stays flexible and cuts fast.



Part No.	Grit	Size	Sheets Per Sleeve	Sleeves Per Case
T 2000	600A	9" x 11"	50	10
T 2001	500A	9" x 11"	50	10
T 2002	400A	9" x 11"	50	10
T 2004	320A	9" x 11"	50	10
T 2007	220A	9" x 11"	50	10

IMPERIAL WETORDRY Color Sanding Paper Sheets

IMPERIAL WETORDRY Color Sanding Paper is designed for light sanding prior to compounding. Sheet size (5 1/2" x 9") eliminates the need of tearing, so entire sheet can be used. Durable backing resists tearing and wrinkling.



Part No.	Grade	Size	Sheets Per Sleeve	Sleeves Per Case
T 2021	Ultra Fine	5 1/2" x 9"	50	10
T 2022	Micro Fine 1200	5 1/2" x 9"	50	10
T 2023	Micro Fine 1500	5 1/2" x 9"	50	10

WETORDRY TRI-M-ITE Paper Pro-Size Sheets

These WETORDRY TRI-M-ITE "Pro-Size" Sheets save time and reduce waste. Sheet size (5 1/2" x 9") eliminates the need for tearing, so entire sheet can be used. Use wet with water or dry for sanding old finishes, fine feather edging and surface sanding. WETORDRY stays flexible and cuts fast.



Part No.	Grit	Size	Sheets Per Sleeve	Sleeves Per Case
T 2024	600A	5 1/2" x 9"	75	10
T 2026	400A	5 1/2" x 9"	75	10

PRODUCTION Paper Sheets (Open Coat)

Dry sanding only on machine or by hand. Open coat resists loading and works well for shaping and finishing plastic filler and feather-edging.



Part No.	Grit	Size	Sheets Per Sleeve	Sleeves Per Case
T 2112	150C	9" x 11"	100	10
T 2113	120C	9" x 11"	100	10
T 2115	80D	9" x 11"	50	10
T 2134	100C	2 3/4" x 17 1/2"	200	10
T 2135	80D	2 3/4" x 17 1/2"	100	10
T 2138	40D	2 3/4" x 17 1/2"	100	5
T 2139	36D	2 3/4" x 17 1/2"	100	5
T 2145	80D	3" x 8"	200	10
T 2175	80D	3 3/8" x 9"	200	10
T 2178	40D	3 3/8" x 9"	200	5

BODY SHOP

GREEN CORPS PRODUCTION FRE-CUT Paper Sheets

For sanding with airfile or hand file board. Tough mineral bond construction along with special treatment, to resist loading, means long lasting, fast cutting abrasive. Excellent for sanding plastic filler.

Part No.	Grit	Size	Sheets Per Box	Boxes Per Case
T 2220	80D	2 3/4" x 17 1/2"	100	5

GREEN CORPS PRODUCTION Paper Sheets

Dry sanding only with hand file or air file. Special mineral coating plus improved mineral bond means long-lasting, fast cutting abrasive life. Excellent for sanding plastic and for feather-edging.



Part No.	Grit	Size	Sheets Per Box	Boxes Per Case
T 2221	40E	2 3/4" x 17 1/2"	100	5
T 2222	36E	2 3/4" x 17 1/2"	100	5

GREEN CORPS STIKIT PRODUCTION FRE-CUT Paper Sheets

Sheets have pressure sensitive adhesive backing for easy application to and removal from tool face. Tough mineral bond construction along with special treatment, to resist loading, means long lasting, fast cutting abrasive.

Part No.	Grit	Size	Sheets Per Box	Boxes Per Case
T 2230	80D	2 3/4" x 16 1/2"	100	5

GREEN CORPS STIKIT PRODUCTION Sheets

Sheets have pressure sensitive adhesive backing for easy application to and removal from tool face. Special mineral coating plus improved mineral bond provides for long-lasting, fast cutting abrasive life.

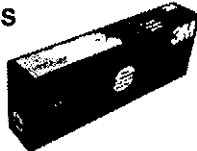

Part No.	Grit	Size	Sheets Per Box	Boxes Per Case
T 2231	40E	2 3/4" x 16 1/2"	100	5

STIKIT PRODUCTION Sheets

Sheets have pressure sensitive adhesive backing for quick application to tool face. Size provides material for folding over ends to work in small areas. Sheets are specially treated to prevent loading and have a durable backing.

Part No.	Grit	Size	Sheets Per Box	Boxes Per Case
T 2241	80D	2 3/4" x 16 1/2"	100	5
T 2248	40D	2 3/4" x 16 1/2"	100	5
T 2249	36D	2 3/4" x 16 1/2"	100	5

PRODUCTION FRE-CUT Paper Sheets (Open Coat)

Dry sanding only. Special treatment for minimum loading and longer lasting when shaping and finishing plastic filler feather-edging with machine or by hand.

Part No.	Grit	Size	Sheets Per Sleeve	Sleeves Per Case
T 2397	80D	3 3/8" x 9"	200	10
T 2400	80D	2 3/4" x 17 1/2"	100	10

TRI-M-ITE FRE-CUT Paper Sheets

Dry sanding only. Special treatment for minimum loading when sanding surfaces, old finishes or fine feather-edging. When ordering TRI-M-ITE FRE-CUT, select two grits coarser than WETORDRY TRI-M-ITE normally used to obtain a comparable finish.

Part No.	Grit	Size	Sheets Per Sleeve	Sleeves Per Case
T 2344	320A	9" x 11"	100	10
T 2347	220A	9" x 11"	100	10
T 2348	180A	9" x 11"	100	10
T 2349	150A	9" x 11"	100	10
T 2360	180A	2 1/2" x 17 1/2"	200	10
T 2383	220A	3 3/4" x 9"	400	10

CRYSTAL BAY Emery Cloth Sheets CRYSTAL BAY Crocus Cloth Sheets

Emery Cloth is used for general purpose metal sanding, light clean-up work and rust removal jobs. Crocus Cloth is purely a polishing medium for use on metal surfaces.

Part No.	Grit	Size	Sheets Per Sleeve	Sleeves Per Case
T 2431	Fine	9" x 11"	50	10
T 2433	Coarse	9" x 11"	50	10
T 2435	Crocus Cloth	9" x 11"	50	10

STIKIT Gold Sheet Rolls

STIKIT Gold Sheet Rolls are coated abrasive rolls with a pressure sensitive adhesive backing for quick adhesion to and easy removal from STIKIT file shoes. Use with the STIKIT Double Roll Dispenser, Part No. 05452, to cut desired length for use on file shoes, sanding blocks or file boards.

Part Number	Grit	Size	Rolls Per Case
T 2591	320A	2 3/4" x 45 yds.	10
T 2595	180A	2 3/4" x 45 yds.	10
T 2599	80A	2 3/4" x 25 yds.	10

STIKIT Disc Roll Dispenser

This handy "disc jockey" stores, carries and dispenses two rolls of STIKIT Discs simultaneously. A single disc can be removed with one hand. Set dispenser on hood or rear deck, rubber feet protect car's finish. Lightweight, easy to carry, has no moving parts and shows remaining disc supply at a glance.

Part No.	Quantity Per Case
T 5450	1

WETORDRY Rubber Squeegees

Made of flexible rubber in two sizes. The 3" x 2" size is used for removing slush created when sanding with water while the 2 3/4" x 4 1/2" size is used for applying glazing putty and plastic filler.



Part No.	Size	Quantity Per Case
T 5517	2 3/4" x 4 1/2"	50
T 5518	3" x 2"	50

3M ROLOC Disc Pad Assembly

A hard rubber back-up pad for use with ROLOC Discs. Pad assemblies come complete with a 2" steel shaft and adapter.



Part No.	Diameter	Shaft	Quantity Per Case
T 5539	2"	1/4" Diameter	10
T 5540	3"	1/4" Diameter	10

BODY SHOP

STIKIT Disc Pad

Specially made for use with STIKIT Discs. The vinyl pad face provides good disc adhesion yet allows easy disc removal. Both pads are lightweight, shock resistant and well balanced. Made with a tough, durable plastic hub and a conformable foam "body". Maximum operating speed for both pads is 7000 RPM.

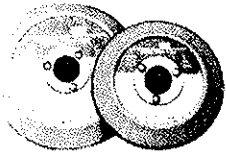

Part No.	For Use With Disc Size	Pads Per Case
T 5576	6" diameter	10

3M PAINT BUSTER Disc Pads

3M PAINT BUSTER Disc Pads offer firm support for tough grinding yet are flexible enough to conform to surface contours. Pad construction is designed to resist chunking, reduce edge-wear and prolong pad life. Maximum operating speed for both pads is 6000 RPM.



Part No.	For Use With Disc Size	Quantity Per Case
T 5634	7" diameter	10
T 5635	9 1/4" diameter	10

3M SUPERBUFF Buffing Pad

The 3M SUPERBUFF Buffing Pad has a unique double face construction allowing both sides of the pad to be used plus its own built in light-weight support pad eliminates the need for heavy back-up pads. The soft usable edge means those hard-to-get-at areas are no longer a problem and edge burn is virtually eliminated.



Part No.	Pads Per Case
T 5700	48

3M SUPERBUFF 2 plus 2 Pad

"2 plus 2" features 2 sides to buff with plus 2 major advantages.

- More flexible - Gets into tight areas and reverse curves more easily.
 - Longer life - provides greater economics to your buffing operation.
- Heavy back-up pads are eliminated by the "2 plus 2" pads own lightweight support system.



Part No.	Pads Per Case
T 5701	24

3M SUPERBUFF Polishing Pad

The 3M SUPERBUFF Polishing Pad is a double sided, soft edge polishing pad, specially designed for use with a polisher and glaze. Made of extremely fine fibers, the SUPERBUFF Polishing Pad produces a high gloss on paint surfaces. Other features include: long life, flexibility, light weight and balance.

For compounding prior to glazing, one of the other Superbuff Pads may be used.



Part No.	Pads Per Case
T 5705	12

3M SUPERBUFF Adaptor

Adaptor for the 3M SUPERBUFF Pads (Part Nos 051144-05700, 051144-05701 and 051144-05705)

Part No.	Adaptors Per Case
T 5710	10

3M Flexible Parts Repair Material

A two part material designed for repairing damaged soft auto body parts and bumper covers. 3M Flexible Parts Repair Material is easy to mix, easy to use and offers a short cure time and excellent sandability.



Part No.	Container Size	Kits Per Case
T 5900	2.5 oz. tubes-kit	6

3M brand FINESSE-IT System

3M brand FINESSE-IT Kit is the single source paint repair system designed for correcting imperfections in today's paint finishes. Each kit contains:

- 10 sheets FINESSE-IT IMPERIAL WETORDRY Scalloped Discs, grade Micro Fine 1500, 1 1/2" diameter. 10 discs per sheet.
- 2 each FINESSE-IT Hand Sanding Pads, 1 1/4" diameter.
- 1 pint FINESSE-IT Finishing Material.
- 2 each ROLOC Finishing Pads, 3" diameter.
- 10 each FINESSE-IT Buffing pads, 3" diameter.
- 1 each 3M ROLOC Disc Pad Assembly.



Part Number	Kits Per Case
T 5920	4

*Discontinued as a part numbered item.

3M brand FINESSE-IT II Finishing Material

FINESSE-IT II Finishing Material is designed for use on OEM and baked refinish paints to remove Grade Microfine 1500 IMPERIAL WETORDRY sand scratches, or to remove swirl marks after compounding, while leaving a glazed finish.



Part Number	Container Size	Containers Per Case
T 5928	32 fl. oz.	12

3M PREP TEAM Liquid Polish

Designed to be used by machine or by hand. 3M PREP TEAM Liquid Polish contains a cleaner for removing surface film and a wax for protective high gloss finish.



Part No.	Container Size	Containers Per Case
T 5939	1/2 Gallon	6

3M PREP TEAM All Purpose Cleaner

3M PREP TEAM All Purpose Cleaner is a powerful water based cleaner that does not attack paint, aluminum or fabrics. Actual cleansing power can be controlled by the amount of water added to the concentrate.

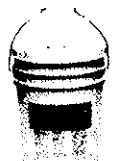

Part No.	Container Size	Containers Per Case
T 5946	Gallon	4
T 5948	5 Gallons	1

BODY SHOP

3M Super Duty Rubbing Compound

Part No. T 5955

Recommended for heavy aggressive compounding of paint. Clings to paint surface — remains wet on the job with little or no mess. Maintains high rate of cut with constant pressure. Buffs to high gloss with minimum of swirl marks. Can be used by hand or machine. Four. 1 gallon containers per case.



3M Fill 'N Glaze — Pink

Special product designed for use on dry, freshly painted surfaces for filling swirl marks after compounding. Let dry to a haze and wipe off by hand. Produces a long lasting deep luster finish.



Part No.	Container Size	Containers Per Case
T 5976	Gallon	4
T 5977	Quart	12

3M Final Glaze

3M Final Glaze fills swirl marks, produces a high gloss finish plus it offers protection to paint while curing. It is a non-silicone glaze and does not contain any wax. It comes in a convenient, easy to handle quart plastic bottle with a flip-top nozzle for quick and easy dispensing.



Part No.	Container Size	Containers Per Case
T 5988	Quart	12

IMPERIAL Hand Glaze

IMPERIAL Hand Glaze is a non-silicone, non-wax hand glaze, with high filling characteristics, excellent depth of shine and superior lustre. Recommended for use by hand to fill swirl marks after compounding acrylic lacquer, it may also be applied to completely cured enamels and urethanes that have been compounded. IMPERIAL Hand Glaze is specially formulated to work on all colors, and can be painted over.



Part No.	Container Size	Containers Per Case
T 5990	Quart	12

IMPERIAL Machine Glaze

IMPERIAL Machine Glaze is a non-silicone, non-wax, machine glaze that possesses excellent scratch removal and filling characteristics and superior depth of shine and lustre. Recommended for use by machine to remove and fill swirl marks after compounding acrylic lacquer, it may also be applied to completely cured enamels and urethanes that have been compounded. IMPERIAL Machine Glaze is specially formulated to work on all vehicle colors.

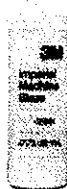

Part Number	Container Size	Containers Per Case
T 5991	Quart	1

IMPERIAL Microfinishing Glaze IMPERIAL Microfinishing Compound

IMPERIAL Microfinishing Glaze, PN05992, and IMPERIAL Microfinishing Compound, PN06031, are designed specifically for finishing fresh, 1 to 2 day old, enamel and urethane color and clear coat paint systems.



	Part Number	Container Size	Quantity Per Case
NEW NEW	T 5992	Quart	12
	T 6031	Gallon	4

SCOTCH Vinyl Plastic Electrical Auto Tape No. 81

SCOTCH Auto-Electric Tape is the first plastic electrical tape specifically designed for use on auto repairs. Even if your fingers are greasy, this tape gets jobs done quickly. Use for splicing wires, harnessing cable, wrapping hoses and countless other shop jobs.

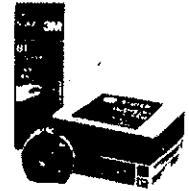

Part No.	Size	Rolls Per Box	Rolls Per Case
T 6100	3/4" x 20 ft.	10	100
T 6101	3/4" x 60 ft.	10	100

Super 33 Plus Vinyl Plastic Electrical Tape

Super 33 Plus is the first and only 7-mil "one tape for all jobs." It wraps and holds in all weather and will continue to perform in sub-zero temperatures or in continuous temperature environment up to 105° C (220° F). Super 33 Plus conforms remarkably and is resistant to oil, water, wear, chemicals and solvents.

Part No.	Size	Rolls Per Box	Rolls Per Case
T 6133	3/4" x 52 ft.	10	100

SCOTCH Pipe Thread Sealant Tape

Pipe Thread Sealant Tape rolls on dry; molds into pipe threads forming a leak proof seal. Works on any automotive line, eliminates messiness of conventional materials. Unaffected by oils, transmission fluid, or freon, never dries out, permanently lubricated joints never stick.

Part No.	Size	Rolls Per Case
T 6195	1/4" x 260"	12

SCOTCHLOK 314 Electrical Connector

SCOTCHLOK 314 Electrical Connectors contain a special compound inside the connector to protect against corrosion in damp conditions. Handles 22-14 AWG solid or stranded wire. Wires are held with a double "U" element to provide a much stronger connection while reducing electrical resistance.

Boxed

Part Number	Connectors Per Box	Boxes Per Case
T 9230	50	10

NEW

BODY SHOP

SCOTCH Fine Line Tape

Fine Line Tape has a special processed film backing that allows taping over freshly painted acrylic lacquer or enamel surfaces sooner and with less chance of imprint damage. This polypropylene film tape provides the finest color separation line possible in multi-color striping and chassis paint applications. SCOTCH Fine Line Tape can be used for lettering, striping and two-tone separation lines in all types of truck and auto refinishing accounts. This tape is **not** designed for outdoor application.



Part No.	Size	Rolls Per Case
T 6300	1/8" x 60 yds	12
T 6301	1/4" x 60 yds.	12
T 6306	1/16" x 60 yds	12

SCOTCH Automotive Refinish Masking Tape No. 233

The superior masking tape designed expressly for the professional auto refinish painter. No. 233 is conformable, hugs curves and contours, goes on quick and easy, sticks at a touch and stays put, every feature perfectly balanced to give outstanding masking results.

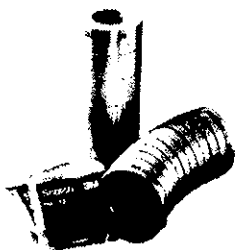

Part No.	Size	Rolls Per Case
T 6332	1/2" x 60 yds. Bulk	72
T 6334	3/4" x 60 yds. Bulk	48
T 6335	7/8" x 60 yds. Bulk	48
T 6336	1" x 60 yds. Bulk	36
T 6338	1 1/2" x 60 yds. Bulk	24
T 6340	2" x 60 yds. Bulk	24
T 6341	3" x 60 yds. Bulk	12
T 6343	1/8" x 60 yds. Boxed	12
T 6344	1/4" x 60 yds. Boxed	12

SCOTCH-MOUNT Automotive Attachment Tape

A closed cell foam tape coated on both sides with a pressure-sensitive adhesive. It is designed for attaching automotive trim molding emblems and other articles where high internal strength is required.

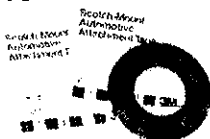

Part No.	Size	Rolls Per Case
T 6376	1" x 72 yds. Bulk	18
T 6377	1" x 20 yds. Boxed	12
T 6378	1" x 20 yds. Boxed	12

SCOTCH-MOUNT Super Automotive Attachment Tape

SCOTCH-MOUNT Super Automotive Attachment Tape has acrylic adhesive on both sides for excellent adhesion in critical applications such as fascia nerf strips and body side moldings. This attachment tape also provides excellent adhesion to all OEM and aftermarket paint systems, especially the high solids lacquers found on all GM cars.

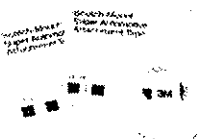

Part No.	Size	Rolls Per Case
T 6380	1/2" x 20 yds. Boxed	12
T 6381	3/4" x 20 yds. Boxed	12

SCOTCH-MOUNT Grey Super Automotive Attachment Tape

SCOTCH-MOUNT Grey Super Automotive Attachment Tape has acrylic adhesive on both sides for excellent adhesion in critical applications such as fascia nerf stripes, bumper trim, wheel lip moldings and door edge moldings. Because of its grey color, this tape "blends in" and is less noticeable. This tape provides excellent adhesion to all OEM and aftermarket paint systems.



Part Number	Per Box	Quantity Per Case
T 6382	1/2" x 20 yds.	12

SCOTCH Brand #471 Plastic Tape - Blue

This uniquely constructed vinyl backed tape offers outstanding paint line definition along with superior holding power for critical masking operations including sharp curves, over rivets and into seams. The tape is packaged in individual poly bags.

Part Number	Size	Rolls Per Case
T 6404	1/8" x 36 yds.	12
T 6405	1/4" x 36 yds.	12
T 6408	1/2" x 36 yds.	12
T 6409	3/4" x 36 yds.	12

SCOTCH Plastic Tape

For lane and stall marking, protecting, mending, color coding parts and pipe or hose lines. Retains true color brightness for prolonged periods. 12 rolls per case.

Scotch 3M

Plastic Tape No. 471

Part No.	Size	Color
T 6420	2" x 36 yds. Boxed	Yellow
T 6423	2" x 36 yds. Boxed	Green

SCOTCH Masking Paper

Strong, flexible and pliable. Formulated to resist penetrations of solvents, lacquers or enamels. For overspray protection for every job, 12 inch width for general masking — 3" or 6" widths for headlights, tail lights, door jambs, chrome edge at side of car and bumpers — 15 inch for side windows and windshields.

Part No.	Size	Rolls Per Case
T 6503	3" x 1000 ft.	6
T 6512	12" x 1000 ft.	3
T 6518	18" x 1000 ft.	2
T 6524	24" x 1000 ft.	1
T 6536	36" x 1000 ft.	1

SCOTCH "Bold Brick" Masking Paper

A high density masking paper specifically manufactured for the Automotive Aftermarket. This masking paper offers excellent paint penetration resistance from solvents used in today's sealers, lacquer and enamel paints and clear coat systems. Protects against dust contamination from paper fibers. Provides good conformability while minimizing premature puncturing and tearing. Available in these popular sizes with a distinctively new "Bold Brick" color for easier identification.



Part No.	Size	Rolls Per Case
T 6612	12" x 750 ft.	3
T 6618	18" x 750 ft.	2
T 6636	36" x 750 ft.	1

BODY SHOP

SCOTCHPRO Box Sealing Tape

(No. 3750 Tape Construction)

A strong film tape that is excellent for box sealing, re-coopage, fiber drum sealing and other heavy-duty packaging applications. Available in 1½" and 2" widths in Tan and Transparent.



Part No.	Size	Color	Rolls Per Case
T 6874	2" x 60 yds.	Trans.	36
T 6879	2" x 60 yds.	Tan	36

SCOTCH Hand Dispensers

Part No. T 6907 for 1½" Tape

Part No. T 6908 for 2" Tape

Provides a quick, easy and inexpensive method for sealing cartons with 1½" or 2" wide rolls of SCOTCH Box Sealing Tape. Lightweight, quick loading, and features metal cutting edge for long life. Packed 6 in a carton.



H-10 Filament Tape Dispenser

Part No. T 6910

Accommodates all listed widths of filament tapes shown. Packed 6 per carton.



H-122 Box Sealing Dispenser

Part No. T 6925

A lightweight and durable hand dispenser for box sealing tapes. Accommodates tape up to 2" wide. Packaged 6 per case.

SCOTCH ATG 752 Dispenser

Part No. T 6927

This dispenser is designed for use with our SCOTCH ATG Tapes for easy dispensing. Packed 6 per case.



M-727 Packing List Tape Dispenser

Part No. T 6944

Designed to accommodate both our Packing List Tape and our LABELGUARD Tape. Accepts tapes up to 5" wide. Unique streamline construction allows for wall or bench mounting. Packed six (6) per case.

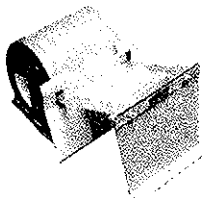

H-171 Box Sealing Dispenser

Part No. T 6955

Provides a quick and easy method for dispensing Box Sealing Tape directly from the roll. Accommodates tape widths up to 2". Packed 6 per case.

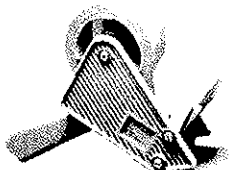

SCOTCH Cloth Tape

(No. 390 Tape Construction)

This tape is designed for applications calling for medium strength and moisture resistance. It has very high instant adhesion. It is used for sealing, patching, and a variety of repair applications where flexibility, conformability, and a moisture-proof tape is required. The silver tape can also be used for a variety of automotive air conditioning and heater line sealing applications. Colors: Olive Drab and Silver.

Part No.	Size	Rolls Per Case	Color
T 6974	4" x 60 yds Bulk	12	Olive

3M Automotive Welding Fume Respirator

Part No. T 6979

The 3M Automotive Welding Fume Respirator provides protection from mists and welding fumes. Application for use include welding and brazing operations where fumes are created that could be hazardous to the workers health. The respirator is lightweight and features an exhalation valve for additional comfort, especially in hot areas. The outer shell and straps are flame resistant. This respirator is NIOSH MSHA approved where the permissible exposure level is not less than .05 mg m³ of air. IT IS NOT DESIGNED FOR USE IN SPRAY PAINT OPERATIONS OR WHERE DUST, FUME OR MIST CONCENTRATIONS ARE GREATER THAN 10 X P.E.L. Packed 10 respirators per case.

3M Automotive Dust Respirator

A lightweight, completely disposable dust respirator that is easy to breathe through, allows the user to talk in a normal tone and doesn't restrict vision. The 3M Automotive Dust Respirator is NIOSH approved and designed to be used in all types of brake and clutch repair operations.



Part No.	Respirators Per Box	Boxes Per Case
T 6983	15	10

3M Non-Toxic Particle Mask

The first truly comfortable mask that provides relief against non-toxic dusts. Made of flexible filter material, specially contoured to stand away from the face. One mask fits all faces — no straps to adjust.



Part No.	Masks Per Box	Boxes Per Case
T 6985	50	12

3M EASI-AIR Spray Paint Respirator

Part No. T 6986

The 3M EASI-AIR Spray Paint Respirator is designed for use in all spray paint applications connected with the refinishing of automobiles, fleets and aircraft maintenance. This respirator effectively protects the user against all types of paint spray. Replacement should be made when vapor taste, odor or other contaminants are evident in the respirator or when the respirator has been exposed to five days of paint shop conditions. This respirator should *not* be used when concentrations of contaminants are unknown or are immediately dangerous to life or health. 10 respirators per case.

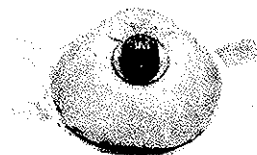

BODY SHOP

3M Brand 6998 Respirator

3M Brand 6998 Respirator is 3M recommended for automotive undercoating. It is NIOSH MSHA approved* for use against dusts and mists with a PEL (permissible exposure limit of .05mg m3 of air. Provides relief from nuisance odors experienced during most undercoating and rustproofing operations. The 6998 Respirator is lightweight, maintenance-free, easy to breathe through and allows clear communication when speaking in normal tones. Read all product instructions and warnings prior to use.



Part No.	Respirators Per Box	Boxes Per Case
T 6998	10	6

*6998 is part no. only. Reference to NIOSH MSHA approval is for 9913 Respirator

SCOTCH-BRITE Light Duty Cleansing Pad No. 98

These pads can be used to clean rusty, corroded surfaces. They are conformable so hard-to-get-at contoured surfaces are easy to reach and because of the open web non-loading construction, they can be easily cleaned and used again.

Part No.	Pads Per Box	Boxes Per Case
T 7445	10	6

SCOTCH-BRITE General Purpose Pad

Part No. T 7447

For scuffing before applying paint and Primer-Surfacer. For used car reconditioning, cleaning upholstery, headliners, doorpads, chrome and cleaning of white wall tires. Made of nylon web — rinse clean — can be used over and over again.



SCOTCH-BRITE Ultra Fine Pad

Part No. T 7448

For final sanding of Primer-Surfacer — Sand the Primer-Surfacer with WETORDRY TRI-MITE Paper Grit 360A — Rub the Primer-Surfacer across the sandscratch with a SCOTCH-BRITE Ultra Fine Pad. Made of nylon web — rinse clean — can be used over and over again.

Part No.	Pads Per Box	Boxes Per Case
T 7447	20	3
T 7448	20	3

DISCS

SCOTCH-BRITE Surface Conditioning Discs

Made of non-woven nylon fibre material impregnated with aluminum oxide mineral, the SCOTCH-BRITE Surface Conditioning Disc is ideal for cleaning light oxidation and removing gasketing residue from a wide variety of surfaces that include engine blocks, heads, valve covers and transmission housings.

Part No.	Grit	Size	Discs Per Bag	Bags Per Case
T 7450	Coarse	4" x NH	10	10
T 7451	Medium	4" x NH	10	10
T 7458	Coarse	2" x NH	50	4
T 7459	Medium	2" x NH	50	4

SCOTCH-BRITE Clean 'N Strip Discs

The SCOTCH-BRITE Clean 'N Strip Disc is an open mesh disc made from a tough, abrasive impregnated material. The perfect alternative to wire brushes for tough cleanup jobs on almost any type surface.

Part No.	Size	Discs Per Bag	Bags Per Case
T 7460	4" Diameter	10	3

3M Wheel Mandrel

Part No. T 7491

Wheel rounded for use with SCOTCH-BRITE Clean 'N Strip Discs. Mandrel size is 2" long with 1/2" shank. Includes locking washers. Packed 1 per bag.

VANGARD Lenses

VANGARD wide-angle window lenses reduce the chance of squeeze accidents caused by vehicles hiding under passenger doors or hugging bumpers. Made of thin flexible plastic, these lenses provide an extreme wide-angle view. Obstacles can be seen, right down to the pavement; areas rear view mirrors miss. VANGARD lenses are easily applied and removed by hand using water only and they won't damage the glass.



Part No.	Description	Size	Quantity Per Case
T 7950	Vanguard	8" x 10"	12
T 7951	Super Vanguard	11" x 14"	12
T 7952	Vanguard 2	6" x 8"	12

3M Super Weatherstrip Adhesive (Yellow)

For adhering all types of rubber weatherstripping to car doors and trunks. An excellent adhesive for bonding engine gaskets. Can be used for adhering vinyl trim headliners and side panels. Light colored adhesive. Very fast drying, exceptional bonding strength.



Part No.	Container Size	Containers Per Case
T 8001	5 oz. Tube	12

*Discontinued as a part numbered item

3M Super Weatherstrip Adhesive (Black)

3M Super Weatherstrip Adhesive (Black) is a strong, flexible, rubbery adhesive that withstands vibration and extreme temperature variations. This adhesive is primarily designed for use on T-Tops, Moon-Roofs and Sun-Roofs to provide the strength and rapid setting needed to hold weatherstripping and gaskets in place caused by the odd configurations these types of roofs have. Also, because of its black color, cleanup is eliminated due to its blending with the rubber.



Part No.	Container Size	Containers Per Case
T 8008	5 oz. Tube	12

BODY SHOP

3M Weatherstrip Adhesive (Black)



A black, fast drying adhesive used for bonding and sealing weatherstripping. Also an excellent adhesive for new E.P.D.M. weatherstripping. It is waterproof, easy to apply and remains flexible. Black color matches weatherstripping.

Part No.	Container Size	Containers Per Case
T 8011	5 oz. Tube	12

3M Fast Tack Trim Adhesive

A light colored extremely fast drying non staining adhesive with long tack for attaching vinyl and other kinds of trim fabric, upholstery cloth, floor mats and carpeting, kick pads, silencer pads and convertible tops to painted or bare metal, wood, KB board or other fabric. Also useful as a gasket adhesive to hold gaskets in place while assembling parts.

Part No.	Container Size	Containers Per Case
T 8031	5 oz. Tube	12

3M Feathering Disc Adhesive

A transparent, fast drying adhesive for adhering paper or cloth-backed abrasive discs to cloth, sponge rubber, metal, plastic sponge or sisal back-up plates.

Part No.	Container Size	Containers Per Case
T 8041	5 oz. Tube	12

3M Top and Trim Adhesive

A powerful contact adhesive for adhering vinyl tops. Is easily brushed or sprayed on and won't "grab" until firmly pressed in place. No staining of the vinyl or bleed thru. Ideal for various interior trim applications as well.

Part No.	Container Size	Shipping Weight
T 8046	5 Gal. Pail	38 lbs.
T 8049	54 Gal. Drum	401 lbs.

5 Gallon Pail equals 1 Case. 54 Gallon Drum equals 15 Cases.

3M Feathering Disc Adhesive Type II

Type II Feathering Disc Adhesive is especially formulated to allow multiple disc applications without adhesive buildup or paper delamination. Discs remove easily and cleanly.

Part No.	Container Size	Containers Per Case
T 8051	5 oz. Tube	12

3M Spray Disc Adhesive

A transparent, instant tack adhesive for bonding automotive feathering discs. Fan Spray control, instant tack, many discs per adhesive application and little pad build-up makes it ideal for automotive use.

Part No.	Container Size	Containers Per Case
T 8054	8 oz. Aerosol	6

3M Plastic and Emblem Adhesive



An excellent clear adhesive for plastic repair and emblem application. Use this strong, quick-drying adhesive for plastic or metal emblems, interior rigid plastic, tail light lenses, vinyl side moldings or upholstery.

Part No.	Container Size	Containers Per Case
T 8061	5 oz. Tube	12

3M General Trim Adhesive



A rapid drying, high strength, light colored adhesive in an aerosol container. Designed for bonding most types of material used in automotive trim operations except unsupported vinyl. Excellent for fabrics, upholstery, foam, jute pads, carpets, rebonding vinyl top sections, etc. Has adjustable spray pattern, high initial strength and does not require shaking or agitation before using. Provides good heat resistance.

Part No.	Container Size	Containers Per Case
T 8080	24 oz. Aerosol	6

3M Super Tack Adhesive

3M Brand Super Tack Adhesive sprays easily, dries quickly to a super sticky film. Adheres to metals, cork, rubber, plastics and other automotive materials. Holds gasket in place, even overhead, but allows repositioning if needed. Resists water, anti-freeze coolant solutions, gasoline, lubricating oil, transmission oil, brake fluid and grease. Blue color shows coverage. Narrow spray pattern cuts down overspray and reduces waste.

Part No.	Container Size	Containers Per Case
T 8082	16 oz. Aerosol	6

3M Super Trim Adhesive

3M Super Trim Adhesive is a fast acting, high strength, aerosol contact adhesive designed for two-surface application. This adhesive is resistant to heat and plasticizing oils and is excellent for attaching vinyl tops, headliners, vinyl trim, insulation, foam, padding, and rubber parts to metal and other surfaces. Bonds can be made within minutes of application or as long as one hour later.

Part No.	Container Size	Containers Per Case
T 8090	24 oz. Aerosol	6

3M Structural Adhesive

A two part general purpose structural adhesive that may be used for bonding auto glass to metal retainers and also for trim ornaments and miscellaneous fiberglass repair.

Part No.	Container Size	Kits Per Case
T 8101	2 - 2 fl. oz. Kit	6

3M Hood Flutter Repair Kit

The 3M Hood Flutter Repair Kit is designed to rebond inner hood panels to outer hood panels due to separation of the mastic that bonds these panels together. This repair kit is a two-part, fast-curing structural adhesive in an easy to mix, one shot applicator package.

Part No.	Container Size	Containers Per Case
T 8105	6 oz.	3

AUTOMIX Door Skin Bonding Kits

Part No. T 8109

A two-part structural adhesive designed for attaching automobile door skins without welding. This adhesive is mixed and dispensed through the AUTOMIX system. AUTOMIX Door Skin Bonding Kits offer 25 minutes of work time to properly position door skin and cured strength equal to or stronger than a welded repair. AUTOMIX Door Skin Bonding Kits eliminate the corrosion normally caused by welding. (3 kits per case)

BODY SHOP

3M Quick Fix Adhesive (cyanoacrylate)

3M Quick Fix Adhesive (cyanoacrylate) is a strong, rapid bonding, convenient to use adhesive that has good adhesion to rubber weatherstripping, vinyl, metal, glass, side moldings, emblems, trim pieces and most plastics. This product has excellent resistance to temperature extremes, shock (such as slamming a door) and most automotive fluids.

Part Number	Size	Quantity Per Case
T 8155	1 oz. Bottle	12

3M FLEXICLEAR Body Seam Sealer

3M FLEXICLEAR Body Seam Sealer is a clear, non-sagging, very flexible seam sealer for sealing automotive as well as recreational vehicle seams and joints. This product may be used as received or can be mixed with paint to match existing finish. 3M FLEXICLEAR Body Seam Sealer has exceptionally good tooling properties and is tack free in about 15 minutes.

Part No.	Container Size	Containers Per Case
T 8405	Fits 1/2 Gallon Cartridge Gun	12

*Discontinued as a part numbered item

3M Fast 'N Firm Seam Sealer

3M Fast 'N Firm Seam Sealer is a firm setting product for sealing interior and exterior joints. Adheres well to clean, bare metal, primed metal and painted surfaces. Skins over quickly, can be painted in about 30 minutes. Has excellent tooling and sanding properties and exhibits low shrinkage and good resistance to weathering after cure. Also ideal as a general purpose water and dust sealer. Will withstand mild forced drying.



Part No.	Container Size	Containers Per Case
T 8505	Fits 1/2 Gallon Cartridge Gun	12

3M Auto Bedding and Glazing Compound

A non-hardening water resistant, medium bodied sealer for sealing auto body, seams, under moldings and between windshield rubber and car body. Remains permanently soft and pliable without shrinking to absorb movement in the auto body. Neutral color is clean and easy to use, black color eliminates clean-up on windshield rubber, etc. Easy to Use — Stop-Flo Plunger on each cartridge prevents oozing. Has dry rag cleanup.

Part No.	Container Size	Containers Per Case	Color
T 8509	Fits 1/2 Gal. Cart. Gun	12	Black

3M Heavy Drip-Check Sealer (Gray)

An easy-to-use, fast drying flexible rubber sealer. Has the right flow to permanently seal small cracks and openings. Ideal for use in drip rails, moldings, cowlings and welded seams. Can be painted within 30 minutes. Heavy Type for sealing vertical seams. Resists most automotive fluids.

Part No.	Container Size	Containers Per Case
T 8531	5 oz. Tube	12

3M Clear Auto Sealer

A non-yellowing, optically clear sealer for sealing windshields, drip moldings, reveal moldings, truck ornaments, taillights, and other small seams on the auto body. Also useful for sealing convertible tops and matching convertible back lights.



Part No.	Container Size	Containers Per Case
T 8551	5 oz. Tube	12

3M Strip-Calk

For sealing openings in the car body where a soft non-hardening material is needed. Good for use in seams, cracks in joints, trunks, cracks around pillar posts, cowlings and windshields. Strip-Calk is waterproof, will not shrink, requires no application tools, can be painted.

Part No.	Container Size	Containers Per Case	Color
T 8568	Box of 60 1 ft. Lengths	12	Gray
T 8575	Box of 60 1 ft. Lengths	12	White
T 8578	Box of 60 1 ft. Lengths	12	Black

*Discontinued as a part numbered item

3M WINDO-WELD Sealer (Black)

This sealer is a one-part polysulfide adhesive sealant designed for use in the replacement of "Bonded" Windshields and backlites. Also ideal for providing a supplementary seal for windshields installed with Butyl Tape. Requires no primer.



Part No.	Container Size	Containers Per Case
T 8606	Fits 1/2 Gallon Cartridge Gun	12

3M WINDO-WELD Sealer-Urethane (Black)

A one part adhesive sealant designed specifically for use in the replacement of "bonded" windshields and backlites. It features excellent handling, performance and curing properties that make it ideal for the reinstallation of automotive glass. Requires no primer.

Part No.	Container Size	Containers Per Case
T 8607	Fits 1/2 Gallon cartridge Gun	12

3M Super Fast Urethane (Black)

3M Super Fast Urethane is a rapid-curing adhesive sealant intended for all flush mounted and bonded windshield or backlite replacements. This black, odorless product is easily applied, cures quickly and provides the necessary strength for automotive glass replacement.

Part No.	Container Size	Containers Per Case
T 8609	10 fl. oz. cart.	12

BODY SHOP

3M WINDO-WELD Ribbon Sealer (Black)

WINDO-WELD Ribbon Sealer is a "Tape type" sealer used in the replacement of windshields and backlites on all "gasket-less" car models. Its unique feature of "controlled" compressibility allows easy installation yet will not squeeze out or allow lites to contact pinch-weld.

One kit or one 15 Ft. Roll is sufficient material to replace one windshield or backlite. One 30 Ft. Roll is sufficient material to replace two windshields or backlites.

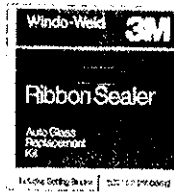

Part No.	Container Size	Kits Per Case
INDIVIDUAL KITS — Round Bead Contains one roll of sealer and setting blocks.		
T 8610	Kit — 1/4" x 15 ft.	12
T 8611	Kit — 3/16" x 15 ft.	12
T 8612	Kit — 3/8" x 15 ft.	12

3M WINDO-WELD Resealant (Black) (Flow Grade)

Developed to stop leaks in new cars installed with "bonded" windshield and backlites, useful as a supplementary seal when windshields are repaired with WINDO-WELD Ribbon Sealer. Flows easily in pinholes and crevices and around retainer clips and spacer blocks. Dries fast and remains flexible. Adheres to glass, painted metal and synthetic rubber sealers.



Part No.	Container Size	Containers Per Case
T 8633	Pint Can†	6
T 8634	Fits 1/2 Gallon Cartridge Gun	12

†For use with 051135-08994 Applicator Gun.

3M Channel Bonding Adhesive

A highly flexible, fast curing, 2-part epoxy adhesive designed for bonding auto glass into metal channels. Cured bonds are durable and resist vibration. Will also bond steel, aluminum, wood, plastic and fiberglass. Unique package provides ease of mixing and application.



Part No.	Kit Size	Kit Per Case
T 8640	7 fl. oz.	36

3M Automotive Joint and Seam Sealer

3M Automotive Joint and Seam Sealer is a firm setting, but flexible sealer for interior and exterior auto body joints and seams. Typical applications are in the trunk, floor, and wheel well areas. Adhesion and weathering resistance are excellent. Skins over quickly. Can be painted in about 30 minutes. Available in white and black.

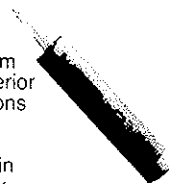

Part No.	Color	Container Size	Containers Per Case
T 8646	White	Fits 1/2 Gallon	12

3M Brushable Seam Sealer (Gray)

3M Brushable Seam Sealer has been specially developed to seal sheetmetal overlap joints that have been spot welded, riveted or bolted together. Applied with a stiff, short bristle brush, it dries quickly without sag or flow to restore factory appearance. It can be painted when dry. Brushable Seam Sealer adheres well to bare or painted metal surfaces, remains flexible and resists oil, fuel and other automotive fluids. Use for sealing floor pans, firewalls, trunk seams, shock absorber mounting towers, around wheelwells, fuel filler splash pans and around headlight and taillight openings.



Part No.	Container Size	Containers Per Case
T 8655	12.5 Fl. Oz.	12
T 8656	Quart	6

*Discontinued as a part numbered item.

3M Body Schutz Rubberized Coating

A fast drying, rubberized protective coating developed to coat, protect and sound deaden a wide variety of automotive parts — door skins, quarter panels, wheelwells, fenders, etc. Excellent resistance to salt spray, weathering and abrasion. Excellent adhesion to steel, primer and automotive paints. For painting, follow the paint manufacturing system for painting flexible surfaces.

Part No.	Container Size	Containers Per Case
T 8864	Quart Can	6

3M Rocker Schutz (Beige)

3M Rocker Schutz is a fast drying, paintable, chip-resistant coating for use on motor vehicles that resists weathering, salt spray and abrasion. It matches the original textured coating found on rocker panels, valances, etc., and is paintable 30 minutes after application. 3M Rocker Schutz should be applied with our 3M Body Schutz applicator Gun Part No. 051135-08997.

Part No.	Container Size	Containers Per Case
T 8874	Quart Can	6

UNDERSEAL Brand Rubberized Undercoating

A rapid drying, rubberized undercoating in an aerosol container. Ideal to coat, protect or sound deaden door skins, quarter panels, wheelwells, fenders, etc. Aerosol container permits convenient access to difficult to reach areas. Excellent resistance to salt spray, weathering and abrasion. Excellent adhesion to steel primer and automotive paints. If painted, a "flex agent" must be added to the paint.



Part No.	Container Size	Containers Per Case
T 8883	24 oz. Aerosol	6

3M Rust Fighter — I (Internal Coating Compound)

3M Rust Fighter-I is an amber-colored, runny product ideal for restoring corrosion protection during the spot repair of hemming flanges, door skins, rocker panels, etc. Rust Fighter-I is intended for use as an internal coating compound. It remains tacky, flexible and pliable after application.



Part No.	Container Size	Containers Per Case
T 8892	24 oz. Aerosol	6

BODY SHOP

3M Rust Fighter — E (External Coating Compounding)

3M Rust Fighter-E is a black, abrasion-resistant coating ideal for corrosion protection and sound deadening when applied to quarter panels, wheelwells, fenders, etc. Rust Fighter-E sprays easily, dries quickly, and can be used for coating small and or repaired areas. Rust Fighter-E is intended for use as an external coating compound.



Part No.	Container Size	Containers Per Case
T 8893	24 oz. Aerosol	6

*Discontinued as a part numbered item

3M Woodgrain and Stripe Remover

For removing Woodgrain Vinyl and Vinyl Stripes from Acrylic enamel surfaces. Jelly-like consistency keeps remover in place on vertical surfaces to promote fast action when sprayed from the aerosol can. Saves on repair and repaint. Removal is facilitated by use of plastic scraper. Part No. 051135-08990. For removal of adhesive residue follow up with use of Part No. 051135-08908 Adhesive Remover.



Part No.	Container Size	Containers Per Case
T 8907	24 oz. Aerosol	6

3M Woodgrain and Stripe Adhesive Remover

Cleans off adhesive residue after Woodgrain Vinyl or Vinyl Stripes have been removed. This fast acting remover can be used on all acrylic enamel painted metal surfaces. Jelly-like consistency keeps remover in place on vertical surfaces to promote fast action when sprayed from an aerosol can. Removal is facilitated by use of plastic scraper Part No. 051135-08990. Saves on repair and repaint of the metal surface.



Part No.	Container Size	Containers Per Case
T 8908	24 oz. Aerosol	6

3M General Purpose Adhesive Cleaner

A specially blended solvent that provides easy cleanup of most types of adhesives and quickly removes waxes, road tars, grease, oil and similar materials. Will not harm thoroughly dried automotive paint, vinyl or fabrics when properly used.



Part No.	Container Size	Containers Per Case
T 8984 T 8986	Quart Can 5 Gallon Can	6 1

3M Cartridge Applicator Gun

Part No. T 8992

1/2 gallon Cartridge Gun for use with Auto Bedding and Glazing Compound and Windo-Weld Sealer. Twelve per case.



3M Applicator Gun

Part No. T 8994

For applying 3M Automotive Adhesives and Sealers. Gun is furnished with two tips. Windshield Sealer application tip and an all purpose needle tip. Twelve per case.

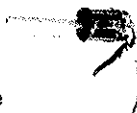

3M Body Schutz Applicator Gun

Part No. T 8997

Developed to provide a unique, convenient and inexpensive means of spraying 3M Brand Rubberized Body Schutz Coating. One per case.



MARSON X-TEND

Restores "dry" body fillers. Also used to thin fillers for a finish skim coat. Use with fillers requiring cream style hardeners only.

X01110 pint 12/cs.



MARSON White Lightnin'

Standard weight premium grade body filler. Features smooth texture, consistent curing and good adhesion. Use for all filling requirements on steel, aluminum and most fiberglass surfaces. Can be applied up to 1/4" thick. Uses red cream hardener.

X01175 gallon 12 lbs. 4/cs.



WHITE LIGHTNIN'

Standard weight premium grade body filler. Features smooth texture, consistent curing and good adhesion. Use for all filling requirements on steel, aluminum and most fiberglass surfaces. Can be applied up to 1/4" thick. Use red cream hardener.

X01275 3 gal. Miser Cartr. 2/cs.

GOLDEN EXTRA

Our premium grade lightweight autobody filler. Unique 'golden' formula is tack free, extra smooth and extremely sandable. Use to fill dents and deep scratched in steel and aluminum, or as a final layer over fiberglass repairs.

X01277 3 gal. Miser Cartr. 2/cs.



WHITE FILL

Lightweight professional grade body filler. Features easy mixing, smooth application, less dust and clogging. Use for all filling requirements on steel, aluminum and most fiberglass surfaces. Can be applied up to 1/4" thick. Use red cream hardener.

X01278 3 gal. Miser Cartr. 2/cs.



BODY SHOP

MARSON Cream Hardener

Full strength, factory fresh cream hardeners for use with Marson and other body fillers. Features smooth consistency, brilliant colors for easy mixing.

X10110 Red Gallon Size



MARSON Smoothie

The original full-strength fish-eye eliminator. One ounce will condition gallons of ready-to-spray paint. Improves flow out and gloss. Works with all standard automotive finishes as well as many industrial paints. Available in four different size dispenser packs, or galon refills.

X20232 2 oz. Poly-Bottle with dropper. 6/cs.



MARSON Spreaders

Three spreaders on one card. 3"x4", 3"x5", 4"x6". Reusable.

X20390

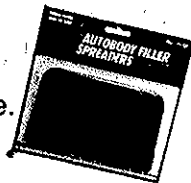

MARSON Spreaders

3"x6" yellow double edge spreaders. 5 per pack. 20/cs.

X20394



MARSON Body Filler File Blades

Popular 10" and 14" lengths in flat and half-round shapes. Use to shape body fillers. Quick cutting and long lasting. Grips give control and comfort while maintaining a "feel" for the work.

21150 Flat 10" 10/cs.

21151 Half round 10/cs.

21155 Flat 14" 10/cs.

21156 Half round 14" 10/cs.

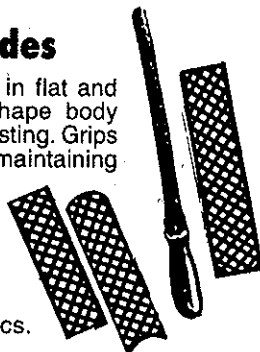

MARSON MISER

Air powered body filler dispenser. For use with all 3-gallon disposable cartridges. Meter valve regulates exact amount of filler required. Eliminates wasted filler.

X21180



MARSON Heat Lamp

Heavy-duty guaranteed 250 watt heat lamps feature built-in reflector and long-life filament. Use for all heating, drying and softening needs.

X22021 250 Watt Heat Lamp 12/cs.

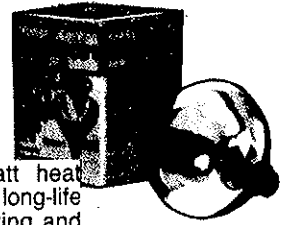

MARSON Wheel Maskers

Protect tire and wheel when painting adjacent panels. Heavy gauge wire ring "locks" masker in place. Will not blow loose. Sold in sets of four for full car coverage. Heavy duty canvas cloth. Fits up to 15" wheel.

X30136 Set of four



MARSON Fiberglass Curtains

Defines work areas and protects adjacent shop areas from overspray. Quality construction features stitched seams, brass hanging grommets. Made from tear resistant, fire retardant materials. Two sizes available for most shop requirements.

X30512 12 ft. high x 12 ft. wide, w/hooks

X30524 12 ft. high x 24 ft. wide, w/ hooks

X30525 Curtain Installation Kit—wire add'l

X30525 Curtain Hanging Wire—50 ft.



MARSON Paint-Cup Gaskets

Supple, durable, snug-fitting leather paint-cup gaskets won't dry out and crack. Packed in newly designed reclosable bag, high-quality leather gaskets stay clean and factory fresh. 6 per bag.

X30612 MC Gaskets 6/bag

Paint-Cup

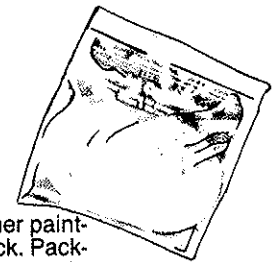

MARSON Polyester Resin

High-strength marine-grade polyester resin. Features quick cure and flexibility. Use for structural fiberglass repairs with Marson cloth and matting or for custom fabrication. Use with clear liquid (MEKP) hardner

X81101 Quart 32oz.



BODY SHOP



MASKING TAPE

Conformable, hugs curves & contours. Quick, easy application, sticks at a touch and stays put.

Nashua
T75MT 3/4"
T2MT 2"



Air Conditioning Tacky Tape

Two-sided, sticky black insulation tape. For insulating air conditioning lines.

T147002

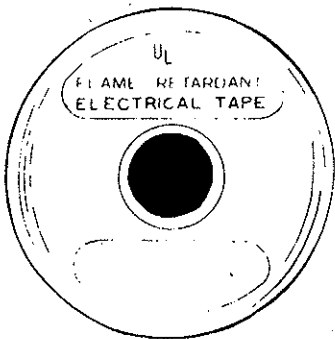

ELECTRICAL TAPE

Flame retardant, cold and weather resistant P.V.C. insulating tape. UL listed complying with CSA standards.

TUL33 3/4" x 33ft.
TUL66 3/4" x 66ft.

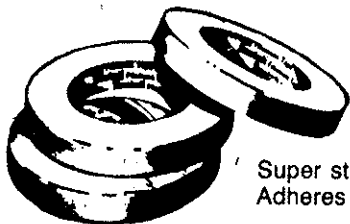

Filament Tape

Super strength, won't break or tear. Adheres instantly.

TMT94 Nylon 3/4"

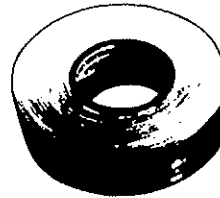

3M Cloth Tape

Designed for applications calling for medium strength and moisture resistance. Has very high instant adhesion. Used for sealing, patching, and a variety of repair applications where flexibility, conformability, and a moisture-proof tape is required. Color: Olive

T6974 4" x 60 yds. 12/cs.

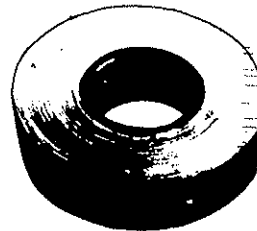

NASHUA Cloth Tape

This new cotton product is designed to give you what you'd expect from a utility tape... PLUS the feature of a professional grade product.

T357 2" Premium Grade
T395 2" Economy Grade

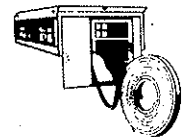
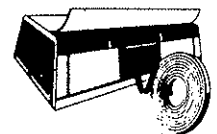

NASHUA Weatherstripping

Adhesive-backed weatherstripping tape. Used to cushion, protect, seal, prevent slippage and insulate.

T80N	1/2"	5/32"	50'
T84N	3/4"	5/32"	50'
T88N	1"	5/32"	50'
T90N	1/2"	5/16"	50'
T94N	3/4"	5/16"	50'

ADVERTISING & MISC. SUPPLIES

SECTION 8

	PAGE
ANTENNA PENNANTS.....	2
AUTO KEY TAGS.....	3,4
BANNERS.....	2
DOOR UNLOCK TOOL.....	2
DRY ERASE MARKERS.....	7
FELT TIP MARKERS.....	6
GLO MARKERS.....	6
HOLD/SOLD TAGS.....	4,5
KEY TAG PLASTIC SLEEVES.....	3
KEY TAG RINGS.....	3
LICENSE PLATE HOLDERS.....	2
MESSAGE BOARD (DRY ERASE).....	7
PAPER FLOORMATS.....	2
PLASTIC PARTS BAG.....	8
PLASTIC SEAT COVER.....	8
PLASTIC PARTS BAG.....	8
SLIM JIM DOOR UNLOCKING TOOL.....	2
WINDSHIELD MARKERS.....	6
WINDSHIELD NUMBERS.....	1
WINDSHIELD SIGNS.....	1
WINDSHIELD STOCK TAGS.....	4

ADVERTISING SPECIALTIES

FLUORESCENT ADHESIVE WINDSHIELD CAR PRICER AND MESSAGE SIGNS

A Ready Selection of Pricing Numerals and Messages Produced in Brilliant Fluorescent Yellow and Black Colors. Each Numeral 7" High - Each Sign 15" Long. SOLD ONLY IN PACKAGES OF 12 PER NUMBER OR SIGN.

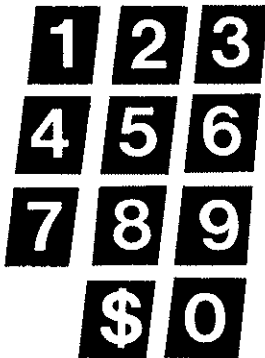

● FLUORESCENT YELLOW NUMBERS ON A BLACK BACKGROUND

UN01 UN06
UN02 UN07
UN03 UN08
UN04 UN09
UN05 UN00
UN0S

● ADHESIVE SIGNS THAT REALLY STAY IN PLACE

UN020	DEMONSTRATOR	UN028	5 SPEED	UN036	AUTOMATIC
UN021	4 CYLINDER	UN029	SPECIAL	UN037	DIESEL
UN022	AS ADVERTISED	UN030	ONE OWNER	UN038	AIR CONDITIONED
UN023	FULL POWER	UN031	LOW MILEAGE	UN039	FRONT WHEEL DRIVE
UN024	LIKE NEW	UN032	EXTRA CLEAN	UN040	EXECUTIVE CAR
UN025	6 CYLINDER	UN033	4 SPEED		
UN026	LOOK	UN034	X		
UN027	REDUCED	UN035	REBATE		

ADVERTISING SPECIALTIES

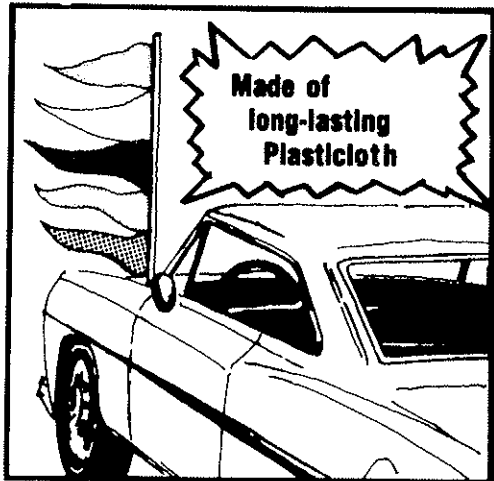

FLUORESCENT AERIAL TOTEM PENNANTS

DRESS UP YOUR FRONT LINE!

FOCUS ATTENTION ON THOSE CARS!

FLUORESCENT PENNANTS SEWN ON FLUORESCENT SLEEVE

Fluorescent... The Newest Pennant on the Market. 10 Times More Brilliant. Weather Resistant. Made of Heavy-duty Plastic Cloth.

UDP156 12/pk.



SLIM JIM

UNIVERSAL AUTO SKELETON KEY

Unlocks most of today's cars.

U32533

FLUORESCENT BANNERS

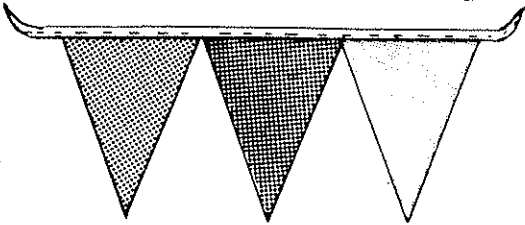

Multi-colored Fluorescent Pennants. 6"x18" each and 60 Feet Long. Heavy-duty, Long Lasting.

UDP185 6x18x60

PAPER FLOOR MAT

This high bulk, 60 pound paper imprinted with a Thank-You message is excellent protection for the plush interior of today's cars.

Size 17½" x 22"
1000 Mats per Case

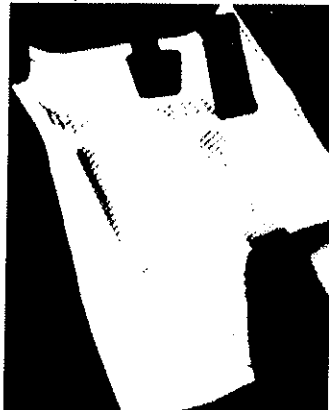

TPAMAT

LICENSE PLATE HOLDERS

<p>MOULDED STRAPS WITH HOLDING KNOBS FORMED IN ONE PIECE — KEEPS PLATE HOLDER IN PLACE</p>	<p>RUBBER PLATE HOLDER</p> <ul style="list-style-type: none"> • ELIMINATES RATTLES • ATTACHES WITHOUT TOOLS • SAVES TIME AND LABOR <p>UJIF1</p> <p>POSITION UNDER HOOD, TRUNK OR STATION WAGON WINDOW</p>
<p>TWO SPRING PLATE HOLDER</p> <ul style="list-style-type: none"> • EASY TO ATTACH • HOOKS OVER BUMPER OR CAR PLATE HOLDER <p>UPH1</p>	<p>WILL NOT SCRATCH OR SLIDE</p>
<p>H.D. CONDUCTIVE TAPE FINISH MAGNETIC (TAPED)</p>	<p>COMPLETELY COATED IN BLACK VINYL FOR TOTAL WEATHERPROOFING MAGNETIC(COATED)</p> <p>UC8</p>

ADVERTISING SPECIALTIES

AUTO DEALER TAGS

UDP-21 Heavy duty card stock, reinforced with metal grommited hole. Furnished with cadmium-plated ring. Stock slogans.
COLOR: White **SIZE:** 1¼x2

UDP-21A Durable heavy tag stock with metal grommet-trimmed hole and cadmium-plated ring at bottom. Provides double-duty rack hanging.
COLORS: Yellow, White, Blue, or Green
SIZE: 1¾x2¾

UDP-811 Heavy duty card stock with 2 metal eyelets for easy hanging and key attachment. With cadmium-plated ring.
COLORS: White or Orange **SIZE:** 1¾x2¾

UDP-812 For the selective buyer. This bright card stock tag has specific descriptive copy. Furnished with cadmium-plated ring.
COLOR: Bright Yellow **SIZE:** 1¾x2¾

UDP-822 Heavy duty card stock with essential copy for auto dealer. Has two key ring holes, one for hanging and one for (included) cadmium ring.
COLOR: Yellow **SIZE:** 1¾x2¾

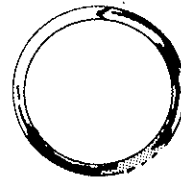

STOCK TAG RING

Rings used for attaching keys to various size tags.

UDP1000 250/pk

PLASTIC SLEEVES

Plastic sleeves for protection of tags are available for the following numbers: UDP-21, UDP-812, UDP-822.

UDP-899

NOTE: All tags are packed 250 per box. Where rings or chains are part of the package, they are not attached.

ABSOLUTE MINIMUM: Only as shown.

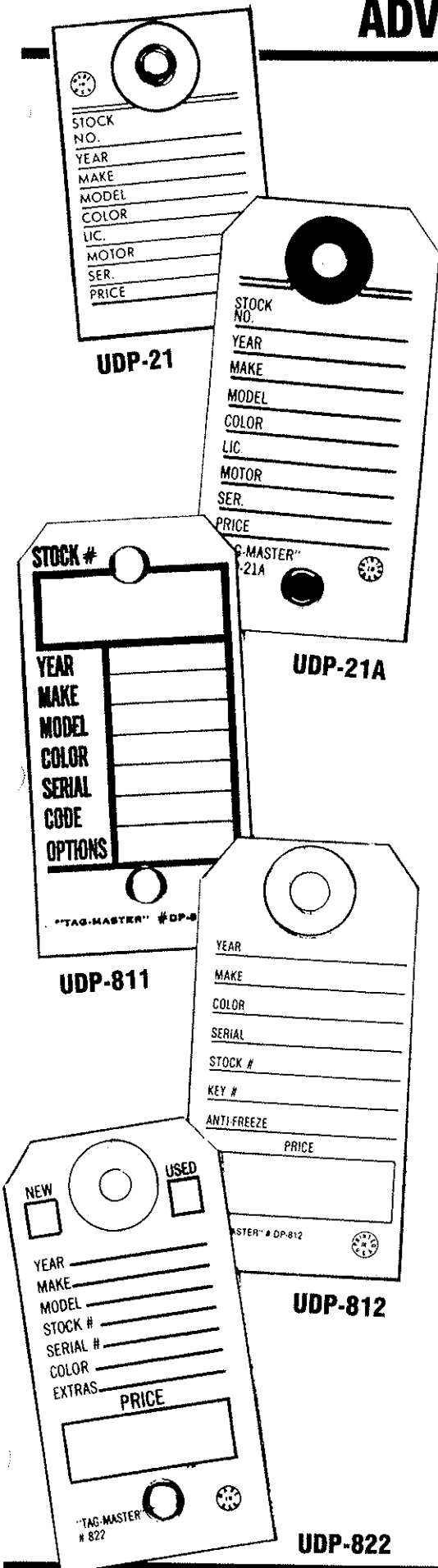

ADVERTISING SPECIALTIES

NEW USED
 YEAR _____
 MAKE _____
 MODEL _____
 STOCK # _____
 SERIAL # _____
 COLOR _____
 EXTRAS _____
 PRICE _____
 "TAG MASTER" DP-840

VINYL "EVER-LAST" AUTO TAGS

Easy write-on surface. Each tag has ring hole on top and bottom. Furnished with cadmium-plated rings.

COLORS: Red
SIZE: 2⁷/₈x1³/₈

UDP840R 250/pk

TO _____
 ADDRESS _____
 REMARKS _____
 SOLD BY _____ DATE _____
 TO BE DEL'D _____
 "SOLD"

"SOLD TAGS"

Valuable for use in most retail and jobber businesses. Attractive, eye-appealing. Black print on heavy red card stock. Slit in center for easy fit over merchandise. Reinforced patch for hanging.

COLOR: Black on Red
SIZE: 4³/₄x2³/₈

UDP-813 250/pk

STOCK # _____
 YEAR _____
 MAKE _____
 MODEL _____
 COLOR _____
 SERIAL _____
 CODE _____
 OPTIONS _____
 TAG MASTER LINE NO. DP-806
 PRINTED IN U.S.A.

WINDSHIELD "STIK-TAG"

Easily identifies all vital car information. Simple removal of strips along the edges exposes pressure-sensitive side for adherence to INSIDE windshield. Can use most ball point or felt tip pens.

COLORS: Bright Red/White
SIZE: 3x3¹/₂

UDP806RW 250/pk

NEW USED
 YEAR _____
 MAKE _____
 MODEL _____
 STOCK # _____
 SERIAL # _____
 COLOR _____
 EXTRAS _____
 PRICE _____
 "TAG MASTER" DP-880
DIRECTIONS
 1. FILL IN TAG.
 2. PEEL PAPER LINER FROM CLEAR SHIELD.
 3. FOLD SHIELD OVER FRONT OF TAG.

SELF-PROTECTING AUTO DEALER TAGS

Provides space for write-in information. PLUS attached self-adhering clear shield—a handy, permanent barrier that is impervious to moisture and the effects of handling and weather. Rings included.

COLORS: White
SIZE: 1³/₁₆x2⁵/₁₆

UDP880 250/pk

ADVERTISING SPECIALTIES

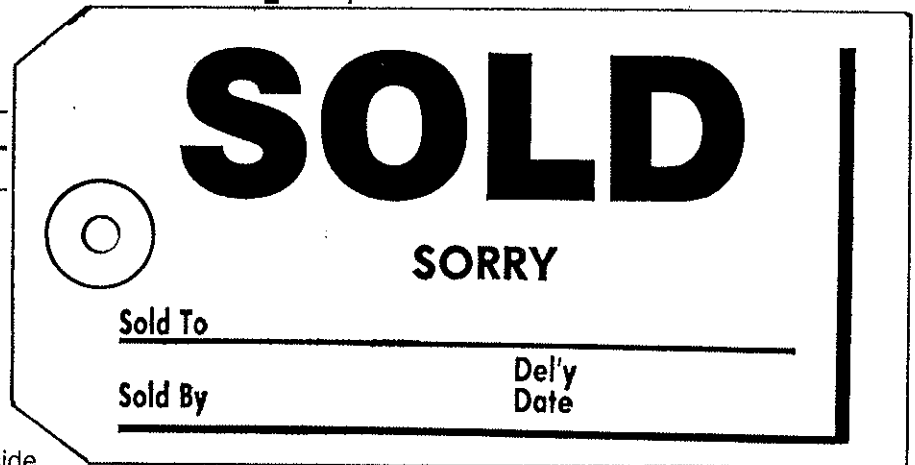
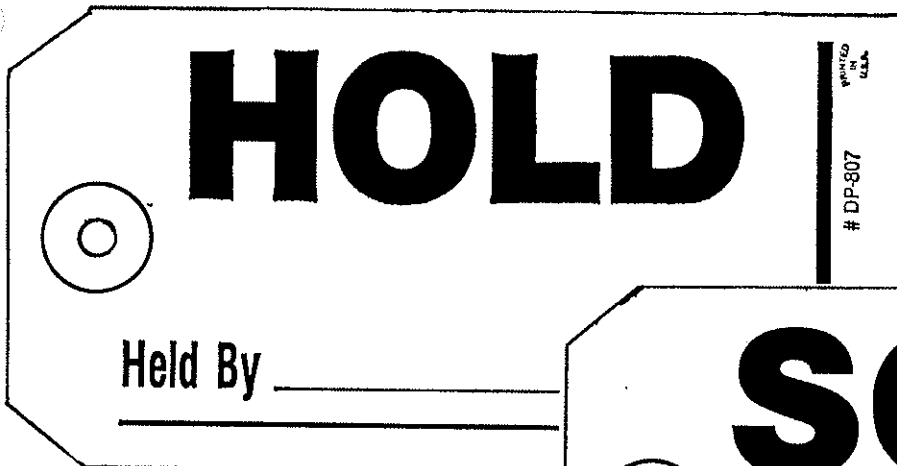

HOLD-SOLD TAGS

Double-duty tag! When sold, use one side of card . . . for deposit only, use the other side. Attractive bright red print on heavy yellow card stock. Slit in center for easy attaching.

UDP-807	(Shown above)	4³/₄x2³/₈	250/pk
UDP-830	(Shown below)	8x4	250/pk

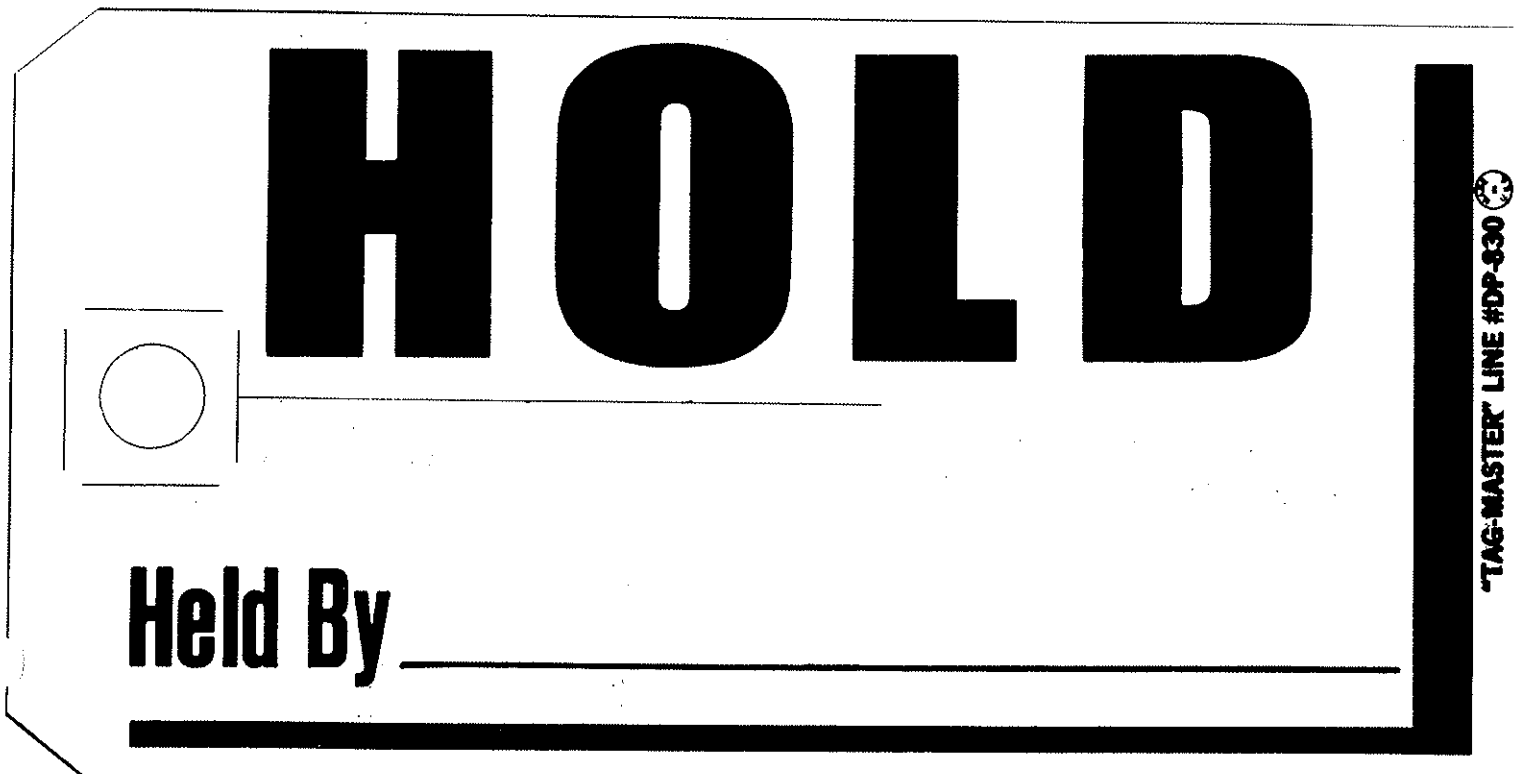

MARKING PRODUCTS



HEAVY-DUTY FELT TIP MARKERS.

Make extra vivid marks on a wide range of materials from metals and plastics to paper and glass. Marks are long lasting, resist weather, water. Dozens of uses, including sign making, marking shipping containers, used equipment and production components.



DESCRIPTION	COLORS
No. TMMBik	Black

MARKAL® ALL-PURPOSE COLD SURFACE MARKERS



MARKAL® PAINTSTIK® "B"

-50 to 150° F.

Real paint in stick form. Ideal for long-lasting, weather-resistant, fade-resistant, abrasion-resistant identification. Leaves bright, highly visible marks on all materials, including asphalt, aluminum, glass, cellophane, marble, green lumber, steel, waxed surfaces and wood. Effective on oily, rough, smooth, wet, dry, icy and rusty surfaces. Available in standard 11/16" diameter. Also available: Markal "B-3/4" for smaller, finer marking.

DESCRIPTION	COLORS
No. TBWHT	White
No. TBYEL	Yellow

MARKAL® PAPER RITER® FELT TIP PEN



Water soluble ink. Odorless. For paper marking. Won't bleed. Use for letters, signatures, signs, blueprints, labeling, sketching, etc. Meets Federal Spec. GG-M-001130 (GSA-FSS).

DESCRIPTION	SIZE
No. TPR30	Fine Line

Colors: Black

MARKAL® BALL PAINT MARKERS



Produce long lasting, weather and water-resistant fine line marks with real paint that dries in minutes. Writes like a pencil on metal, wood—any surface or material. Packaged in unbreakable plastic bottles. Great for marking metal parts, raw steel, semi-finished steel, wood, plastic, rubber, you name it.

DESCRIPTION	COLORS
No. TBPMW	White
No. TBPMY	Yellow

FELT TIP MARKERS

Constructed for rugged, heavy-duty industrial use. They'll out-write all other markers in their price class. Mark on most surfaces or materials. Instant drying, too. Four sizes available: Dura-Ink No. 25 King Size and Dura-Ink No. 20 Medium Size for broad tip marking, No. 15 Sharpie for fine line marking, and No. 50 High Intensity marker.



DESCRIPTION	SIZE
No. TMARK25	King Size



DESCRIPTION	SIZE
No. T10001	Medium

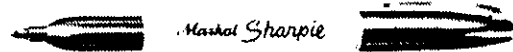

DESCRIPTION	SIZE
No. TMARK15	Fine Point

Colors on the above: Black



GLO-MARKER

A highly visible, rainproof, fluorescent liquid marker that is safe to use on virtually any smooth non-absorbent surface.

TSKRA6	Glo-Marker Kit 3 each of 4 colors		
TSKAG6	Green	TSKAR6	Red
TSKA06	Orange	TSKAY6	Yellow

(12 per case)

ADVERTISING SPECIALTIES

The EXPO TICKLER

The New Dry-Erase Memo Board that Improves Communication.

- The Expo Tickler says it all at a glance. It communicates quickly and clearly. Commands attention and improves communication because it's used!
- Colorful Expo Dry-Erase markers go on wet, dry instantly and wipe off cleanly. No more messy chalk dust or wet cloths.
- The Expo Tickler makes any place a message center. Ideal for the home, office, schools, college dorms, industry, restaurants, hospitals, banks, hotels... almost anywhere.

Make Any Place a Message Center!

Yes! Flow charts, planning boards, production schedules, message centers, visual aids, menus — the size you want and where you want them. A modern chemical break-through from Sanford: Dry erase markers in expressive colors and a self-adhesive polymer surface that can be applied almost anywhere make this the most versatile, practical, readable marking system ever developed. Colors go on wet — dry instantly and wipe off completely with a dry tissue. Compare the advantage of EXPO with any other marking system.

T81901

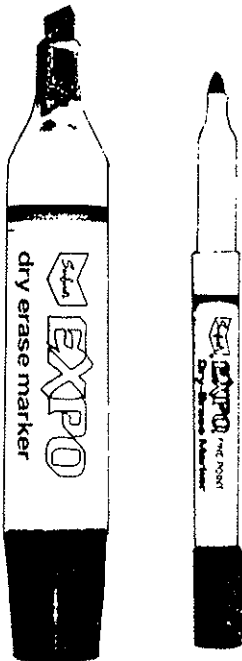
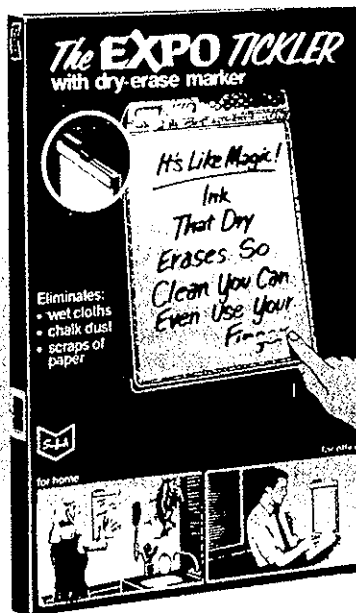

EXPO Dry-Erase Markers

EXPO BROAD TIP

A dry marker that wipes off immediately with a dry tissue. For use on porcelain boards, EXPO marking surface, glass, unpainted metal and glazed ceramics. Standard Pack 1 doz.-same color.

T83001 Black
T83002 Red
T83003 Blue

EXPO FINE POINT

A fine line perfect for charts, graphs, letters or numbers. Standard Pack 1 doz.-same color

T84001 Black
T84002 Red
T84003 Blue

POLYETHYLENE DISPOSABLE GLOVES

- High Quality
- Fits Either Hand
- Embossed For Better Grip
- 1000 Gloves Per Case
- Economical Protection

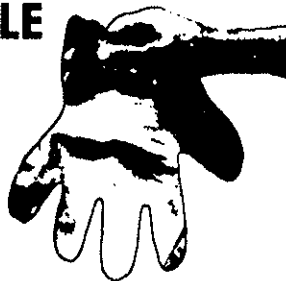

TPLGL

PLASTIC PRODUCTS

PARTS BAG



Keep the inside of your customer's car clean when returning worn parts for inspection.
Size 12" x 20"

TPTS8G

500 per Roll

STEERING WHEEL COVER

ELASTIC BAND



New "shower cap" design gives total protection to the wheel. It fits snug on all makes and models, allows you to see the dash board indicators and protects instrument buttons in the center of the wheel.

TSWC

500 Per Box

PLASTIC SEAT COVER



A durable polyethylene cover with a unique hood designed to fit most any bucket, split bench, or bench seat. A minimum slip differential between the top and bottom surface allows the cover to hold its position on the seat while the mechanic gets in and out of the car.

TPLSC

500 Per Box